



# STORMWATER MANAGEMENT GUIDEBOOK

Prepared for:

District Department of the Environment

Watershed Protection Division

District of Columbia

Prepared by:

Center for Watershed Protection

8390 Main Street

Ellicott City, MD 21043

June 2013





Technical information regarding future updates to the District of Columbia Stormwater Management Guidebook will be available at

<http://ddoe.dc.gov/publication/stormwater-guidebook>

Notices regarding future versions of the manual will be posted at this website. Future versions are expected to occur, at most, once a year.

## Acknowledgements

A major undertaking such as this requires the dedication and cooperative efforts of many individuals. Dr. Hamid Karimi, Director of Natural Resources, Sheila Besse, Associate Director of Watershed Protection, Jeff Seltzer, Associate Director of Stormwater Management, and Timothy Karikari, Branch Chief of Technical Services each deserve credit for their overall leadership and support for this project. Their willingness to allow staff to pursue ideas to their fullest and provide necessary time, resources and managerial support, laid the foundation for much innovation.

### Project Manger

Rebecca C. Stack, DDOE-Technical Services

### Lead Authors

Greg Hoffmann, P.E., Center for Watershed Protection

Rebecca C. Stack, DDOE-Technical Services

Brian Van Wye, DDOE-Stormwater

### Contributors and Peer Reviewers

Joseph Battiatia, P.E., Center for Watershed Protection

Gerald Brock, Ph.D., George Washington University

Josh Burch, DDOE-Planning and Restoration

Collin R. Burrell, DDOE-Water Quality

Walter Caldwell, DDOE-Inspection Enforcement

Jonathan Champion, DDOE-Stormwater

Reid Christianson P.E., Ph.D., Center for Watershed Protection

Laine Cidlowski, Office of Planning

Richard DeGrandchamp, Ph.D., University of Colorado/Scientia Veritas

Elias Demessie, DDOE-Technical Services

Diane Douglas, DDOE-Water Quality

Alex Foraste, Williamsburg Environmental Group, Inc.

Timothy Karikari, P.E., DDOE-Technical Services

Melissa Keeley, Ph.D., George Washington University

Tim Klien, DDOE-Inspection Enforcement

Sarah Lawson, Ph.D., Rainwater Management Solutions

Leah Lemoine, DDOE-Planning and Restoration

Susan Libes, Ph.D., Coastal Carolina University, Conway, SC.

Kelly (Collins) Lindow, P.E., (Center for Watershed Protection)/RK&K

Dennis Lye, Ph.D., US EPA

Massoud Massoumi, DDOE-Technical Services

Abdi Musse, P.E., DDOE-Technical Services

Phetmano Phannavong, P.E., C.F.M., DDOE-Technical Services

Philip C. Reidy, P.E., Geosyntec Consultants

Stephen Reiling, DDOE-Planning and Restoration

Emily Rice, DDOE-Stormwater

Tom Schueler, Chesapeake Bay Stormwater Network

Jeff Seltzer, P.E., DDOE-Stormwater

Tanya Spano, MWCOG-Water Resources

Bill Stack, P.E., Center for Watershed Protection

Meredith Upchurch, DDOE-Stormwater

June M. Weintraub, ScD, San Francisco Department of Public Health



# Table of Contents

Acknowledgements.....	iii
Table of Contents.....	v
List of Tables.....	xv
List of Figures.....	xvii
List of Equations.....	xix
<b>Chapter 1</b> Introduction to the Stormwater Management Guidebook.....	1
1.1 Introduction.....	1
1.2 Purpose and Scope.....	1
1.3 Impacts of Urban Runoff.....	2
1.3.1 Hydrologic Impacts.....	2
1.3.2 Water Quality Impacts.....	4
<b>Chapter 2</b> Minimum Control Requirements.....	7
2.1 District of Columbia Stormwater Management Performance Requirements.....	7
2.2 Stormwater Retention Volume.....	9
2.3 Water Quality Treatment Volume.....	13
2.4 Extreme Flood Requirements (Qf).....	20
2.5 Minimum Criteria for Determining Extreme Flood Requirements.....	20
2.6 Additional Stormwater Management Requirements.....	22
2.7 Hydrology Methods.....	22
2.8 Acceptable Urban BMP Options.....	23
<b>Chapter 3</b> Stormwater Best Management Practices (BMPs).....	27
3.1 Standard Best Management Practice Design Guidance Format.....	27
3.2 Green Roofs.....	28
3.2.1 Green Roof Feasibility Criteria.....	28
3.2.2 Green Roof Conveyance Criteria.....	29
3.2.3 Green Roof Pretreatment Criteria.....	30
3.2.4 Green Roof Design Criteria.....	30
3.2.5 Green Roof Landscaping Criteria.....	34
3.2.6 Green Roof Construction Sequence.....	36
3.2.7 Green Roof Maintenance Criteria.....	38
3.2.8 Green Roof Stormwater Compliance Calculations.....	39
3.2.9 References.....	40

3.3	Rainwater Harvesting.....	41
3.3.1	Rainwater Harvesting Feasibility Criteria .....	42
3.3.2	Rainwater Harvesting Conveyance Criteria.....	45
3.3.3	Rainwater Harvesting Pretreatment Criteria.....	45
3.3.4	Rainwater Harvesting Design Criteria .....	48
3.3.5	Rainwater Harvesting Landscaping Criteria.....	59
3.3.6	Rainwater Harvesting Construction Sequence.....	59
3.3.7	Rainwater Harvesting Maintenance Criteria.....	60
3.3.8	Rainwater Harvesting: Stormwater Compliance Calculations .....	62
3.3.9	References.....	62
3.4	Impervious Surface Disconnection .....	63
3.4.1	Impervious Surface Disconnection Feasibility Criteria .....	64
3.4.2	Impervious Surface Disconnection Conveyance Criteria .....	66
3.4.3	Impervious Surface Disconnection Pretreatment Criteria .....	66
3.4.4	Impervious Surface Disconnection Design Criteria .....	66
3.4.5	Impervious Surface Disconnection Landscaping Criteria .....	69
3.4.6	Impervious Surface Disconnection Construction Sequence.....	70
3.4.7	Impervious Surface Disconnection Maintenance Criteria .....	71
3.4.8	Disconnection Stormwater Compliance Calculations .....	72
3.4.9	References.....	73
3.5	Permeable Pavement Systems.....	74
3.5.1	Permeable Pavement Feasibility Criteria.....	75
3.5.2	Permeable Pavement Conveyance Criteria.....	77
3.5.3	Permeable Pavement Pretreatment Criteria .....	78
3.5.4	Permeable Pavement Design Criteria .....	78
3.5.5	Permeable Pavement Landscaping Criteria .....	85
3.5.6	Permeable Pavement Construction Sequence.....	85
3.5.7	Permeable Pavement Maintenance Criteria .....	90
3.5.8	Permeable Pavement Stormwater Compliance Calculations .....	92
3.5.9	References.....	93
3.6	Bioretention.....	94

3.6.1	Bioretention Feasibility Criteria .....	96
3.6.2	Bioretention Conveyance Criteria.....	99
3.6.3	Bioretention Pretreatment Criteria.....	100
3.6.4	Bioretention Design Criteria.....	101
3.6.5	Bioretention Landscaping Criteria.....	111
3.6.6	Bioretention Construction Sequence.....	116
3.6.7	Bioretention Maintenance Criteria.....	118
3.6.8	Bioretention Stormwater Compliance Calculations.....	120
3.6.9	References.....	121
3.7	Stormwater Filtering Systems.....	123
3.7.1	Filtering Feasibility Criteria.....	131
3.7.2	Filtering Conveyance Criteria.....	133
3.7.3	Filtering Pretreatment Criteria .....	133
3.7.4	Filtering Design Criteria .....	133
3.7.5	Filtering Landscaping Criteria .....	138
3.7.6	Filter Construction Sequence .....	138
3.7.7	Filtering Maintenance Criteria.....	140
3.7.8	Filtering Volume Compliance Calculations.....	141
3.7.9	References.....	142
3.8	Stormwater Infiltration.....	143
3.8.1	Infiltration Feasibility Criteria .....	145
3.8.2	Infiltration Conveyance Criteria .....	148
3.8.3	Infiltration Pretreatment Criteria.....	148
3.8.4	Infiltration Design Criteria.....	149
3.8.5	Infiltration Landscaping Criteria.....	153
3.8.6	Infiltration Construction Sequence .....	153
3.8.7	Infiltration Maintenance Criteria .....	154
3.8.8	Infiltration Stormwater Compliance Calculations .....	156
3.8.9	References.....	156
3.9	Open Channel Systems .....	157
3.9.1	Open Channel Feasibility Criteria .....	160

3.9.2	Open Channel Conveyance Criteria.....	163
3.9.3	Open Channel Pretreatment Criteria.....	163
3.9.4	Open Channel Design Criteria.....	164
3.9.5	Open Channel Landscaping Criteria.....	172
3.9.6	Open Channel Construction Sequence.....	173
3.9.7	Open Channel Maintenance Criteria.....	175
3.9.8	Open Channel Stormwater Compliance Calculations.....	176
3.9.9	References.....	177
3.10	Stormwater Ponds.....	179
3.10.1	Pond Feasibility Criteria.....	181
3.10.2	Pond Conveyance Criteria.....	184
3.10.3	Pond Pretreatment Criteria.....	185
3.10.4	Pond Design Criteria.....	185
3.10.5	Pond Landscaping Criteria.....	190
3.10.6	Pond Construction Sequence.....	191
3.10.7	Pond Maintenance Criteria.....	193
3.10.8	Pond Stormwater Compliance Calculations.....	194
3.10.9	References.....	195
3.11	Stormwater Wetlands.....	196
3.11.1	Wetland Feasibility Criteria.....	198
3.11.2	Wetland Conveyance Criteria.....	200
3.11.3	Wetland Pretreatment Criteria.....	201
3.11.4	Wetland Design Criteria.....	201
3.11.5	Wetland Construction Sequence.....	204
3.11.6	Wetland Landscaping Criteria.....	207
3.11.7	Wetland Maintenance Criteria.....	211
3.11.8	Wetland Stormwater Compliance Calculations.....	212
3.11.9	References.....	213
3.12	Storage Practices.....	214
3.12.1	Storage Feasibility Criteria.....	216
3.12.2	Storage Conveyance Criteria.....	218



3.12.3	Storage Pretreatment Criteria.....	219
3.12.4	Storage Design Criteria.....	220
3.12.5	Storage Landscaping Criteria.....	222
3.12.6	Storage Construction Sequence .....	222
3.12.7	Storage Maintenance Criteria .....	224
3.12.8	Storage Volume Compliance Calculations .....	225
3.12.9	References.....	225
3.13	Proprietary Practices .....	226
3.13.1	Proprietary Practice Feasibility Criteria.....	226
3.13.2	Proprietary Practice Conveyance Criteria.....	226
3.13.3	Proprietary Practice Pretreatment Criteria .....	226
3.13.4	Proprietary Practice Design Criteria .....	226
3.13.5	Proprietary Practice Landscaping Criteria .....	227
3.13.6	Proprietary Practice Construction Sequence.....	227
3.13.7	Proprietary Practice Maintenance Criteria.....	227
3.13.8	Proprietary Practice Stormwater Compliance Calculations.....	227
3.14	Tree Planting and Preservation .....	228
3.14.1	Preserving Existing Trees During Construction .....	228
3.14.2	Planting Trees .....	230
3.14.3	Tree Inspection Criteria .....	235
3.14.4	Tree Maintenance Criteria .....	235
3.14.5	Tree Stormwater Compliance Calculations .....	236
3.14.6	References.....	237
<b>Chapter 4</b>	<b>Selecting and Locating the Most Effective Stormwater Best Management Practice System</b> .....	<b>241</b>
4.1	Choosing Stormwater Management Best Practices (BMPs) .....	241
4.2	Stormwater Management Suitability .....	242
4.3	Land Use Factors .....	244
4.4	Physical Feasibility Factors .....	245
4.5	Community and Environmental Factors .....	248
4.6	Location and Permitting Considerations.....	251
<b>Chapter 5</b>	<b>Administration of Stormwater Management Rules .....</b>	<b>255</b>

5.1	Stormwater Management Plans .....	255
5.1.1	Submittal and Review Process of Stormwater Management Plans .....	255
5.1.2	Resubmission of Stormwater Management Plans.....	261
5.2	Administration .....	261
5.2.1	Approval Requirements .....	261
5.2.2	Fees .....	262
5.3	Inspection Requirements.....	263
5.3.1	Inspection Schedule and Reports .....	263
5.3.2	Inspection Requirements Before and During Construction .....	264
5.3.3	Final Construction Inspection Reports.....	266
5.3.4	Inspection for Preventive Maintenance .....	266
5.4	Maintenance.....	266
5.4.1	Maintenance Responsibility.....	266
5.4.2	Maintenance Agreement .....	267
5.5	Exemptions .....	267
5.6	Supporting Forms.....	268
5.7	Flow Diagram of Plan Review Process .....	281
<b>Chapter 6</b>	<b>Use of Off-site Retention by Regulated Sites.....</b>	<b>287</b>
6.1	Off-Site Retention Overview .....	287
6.2	Off-Site Retention via Stormwater Retention Credits .....	288
6.3	Off-Site Retention via In-Lieu Fee .....	289
6.4	Forms for Use of Off-site Retention .....	289
<b>Chapter 7</b>	<b>Generation, Certification, Trading, and Retirement of Stormwater Retention Credits ....</b>	<b>291</b>
7.1	Stormwater Retention Credits Overview .....	291
7.2	Eligibility Requirements .....	291
7.2.1	Eligibility Requirements: Retention Volume.....	292
7.2.2	Eligibility Requirements: Design and Installation.....	293
7.2.3	Eligibility Requirements: Inspection .....	294
7.2.4	Eligibility Requirements: Maintenance .....	294
7.3	Certification of Stormwater Retention Credits .....	294
7.4	Format of SRC Serial Numbers .....	296
7.5	Failure to Maintain Retention after Certification of Stormwater Retention Credits ...	296
7.6	Buying and Selling Stormwater Retention Credits.....	296

7.7	Voluntary Retirement of Stormwater Retention Credits .....	297
7.8	Quitting the Obligation to Maintain Retention for Stormwater Retention Credits.....	297
7.9	Calculation of Stormwater Retention Credits .....	297
7.10	Stormwater Retention Credit Calculation Scenarios .....	301
<b>Appendix A</b>	<b>Compliance Calculations and Design Examples .....</b>	<b>A-1</b>
A.1	Compliance Calculations .....	A-1
A.2	District of Columbia Stormwater Compliance Spreadsheet .....	A-1
A.3	Design Examples .....	A-9
<b>Appendix B</b>	<b>Maximum Extent Practicable Process for Existing Public Right-of-Way.....</b>	<b>B-1</b>
B.1	Maximum Extent Practicable: Overview.....	B-1
B.2	Public Right-of-Way Projects .....	B-1
B.3	Codes.....	B-4
B.4	Design Considerations .....	B-5
<b>B.4.1</b>	Looking Ahead.....	B-5
<b>B.4.2</b>	Site Assessment Considerations for the Retention Standard in Public Right-of-Way (PROW) Projects.....	B-5
<b>B.4.3</b>	Fundamental Tenets .....	B-10
B.5	Design Process .....	B-10
B.6	Supporting Forms.....	B-15
B.7	References.....	B-15
<b>Appendix C</b>	<b>Off-site Retention Forms for Regulated Sites .....</b>	<b>C-1</b>
<b>Appendix D</b>	<b>Stormwater Retention Credit Forms (Certification, Trading, and Retirement).....</b>	<b>D-1</b>
<b>Appendix E</b>	<b>Relief for Extraordinarily Difficult Site Conditions.....</b>	<b>E-1</b>
E.1	Relief from Extraordinarily Difficult Site Conditions.....	E-1
E.2	Submission requirements for Relief from Extraordinarily Difficult Site Conditions...	E-2
E.3	Review of Requests for Relief from Extraordinarily Difficult Site Conditions .....	E-3
<b>Appendix F</b>	<b>Stormwater Conveyance System Design.....</b>	<b>F-1</b>
F.1	Design of Stormwater Conveyance Systems .....	F-1
<b>F.1.1</b>	Gutters.....	F-2
<b>F.1.2</b>	Inlets.....	F-2
<b>F.1.3</b>	Street Capacity (Spread) .....	F-2
<b>F.1.4</b>	Manhole and Inlet Energy Losses.....	F-3
<b>F.1.5</b>	Open Channels .....	F-3
<b>F.1.6</b>	Pipe Systems .....	F-4

<b>F.1.7</b>	Culverts .....	F-5
<b>F.1.8</b>	Hydraulic Grade Line .....	F-6
<b>F.1.9</b>	Manholes and Inlets .....	F-6
<b>F.1.10</b>	Clearance with Other Utilities .....	F-9
<b>Appendix G</b>	Design of Flow Control Structures .....	G-1
G.1	Design of Flow Control Structures .....	G-1
<b>G.1.1</b>	Circular Orifices.....	G-1
<b>G.1.2</b>	Flow Under Gates .....	G-1
<b>G.1.3</b>	Weirs.....	G-2
<b>Appendix H</b>	Acceptable Hydrological Methods and Models .....	H-1
H.1	Acceptable Hydrologic Methods and Models.....	H-1
H.2	Urban Hydrology for Small Watersheds TR-55 .....	H-2
H.3	Storage-Indication Routing.....	H-5
H.4	HEC-1, WinTR-55, TR-20, and SWMM Computer Models .....	H-5
H.5	Rational Method.....	H-5
H.6	Stormwater Retention Volume Peak Discharge .....	H-6
H.7	References.....	H-8
<b>Appendix I</b>	Rooftop Storage Design Guidance and Criteria .....	I-1
I.1	Rooftop Storage Design Guidance and Criteria.....	I-1
<b>Appendix J</b>	Reserved .....	J-1
<b>Appendix K</b>	Soil Compost Amendment Requirements .....	K-1
K.1	Physical Feasibility and Design Applications.....	K-1
K.2	Design Criteria.....	K-1
K.3	Construction Sequence.....	K-3
K.4	Maintenance.....	K-4
K.5	References.....	K-5
<b>Appendix L</b>	Construction Inspection Checklists .....	L-1
<b>Appendix M</b>	Maintenance Inspection Checklists .....	M-1
<b>Appendix N</b>	Tiered Risk Assessment Management: Water Quality End Use Standards .....	N-1
N.1	Tiered Risk Assessment Management (TRAM): Water Quality End Use Standards for Harvested Stormwater for Non-potable Uses .....	N-1
N.2	Health Risks.....	N-1
N.3	Evaluating the Threat to Public Health.....	N-3
N.4	Applying the Tiered Risk Assessment-Management Approach.....	N-4

<b>Appendix O</b>	Land Cover Designations .....	O-1
O.1	General Notes.....	O-1
O.2	Existing Natural Cover Requirements .....	O-1
O.3	Planting Requirements for the Creation of Natural Cover.....	O-1
O.4	Stormwater Management Plans and Natural Cover.....	O-2
O.5	Construction Requirements for Natural Cover Designation .....	O-3
O.6	Maintenance Requirements for Natural Cover Designation .....	O-3
O.7	Compacted Cover Designation .....	O-4
<b>Appendix P</b>	Geotechnical Information Requirements for Underground BMPs .....	P-1
P.1	General Notes Pertinent to All Geotechnical Testing.....	P-1
P.2	Initial Feasibility Assessment .....	P-1
P.3	Test Pit/Boring Requirements for Infiltration Tests .....	P-2
P.4	Infiltration Testing Requirements .....	P-3
P.5	Infiltration Restrictions .....	P-3
<b>Appendix Q</b>	Stormwater Hotspots .....	Q-1
Q.1	Stormwater Hotspots.....	Q-1
Q.2	Stormwater Hotspot Cover Sheet.....	Q-2
Q.3	Stormwater Hotspot Checklist.....	Q-3
Q.4	Hotspot Operation Pollution Prevention Profile Sheets.....	Q-11
<b>Appendix R</b>	Pollution Prevention Through Good Housekeeping.....	R-1
R.1	Pollution Prevention.....	R-1
R.2	Stormwater Management Plan (SWMP) Good Housekeeping Stamp Notes .....	R-1
<b>Appendix S</b>	Integrated Pest Management .....	S-1
S.1	Integrated Pest Management.....	S-1
S.2	Components of an Integrated Pest Management Plan .....	S-1
S.3	Sample Form for an Integrated Pest Management Plan.....	S-2
<b>Appendix T</b>	Proprietary Practices Approval Process .....	T-1
T.1	Proprietary Practice Consideration Overview .....	T-1
T.2	Types of Manufactured Treatment Devices.....	T-1
T.3	Proprietary Practice Approval Process – Background.....	T-2
T.4	MTD Current Approval Status.....	T-3
T.5	Nutrient Reduction Performance .....	T-4
T.6	MTD Approval Status Renewal.....	T-4
T.7	MTD Application Fees .....	T-4
T.8	References.....	T-5

**Appendix U** References ..... U-1  
**Appendix V** Definitions ..... V-1

## List of Tables

Table 1.1 Common Pollutants in Urban Stormwater Runoff and Their Sources (Municipal Handbook, State of California, 1993).....	5
Table 2.1 Sizing Criteria for Stormwater Management Performance Requirements .....	8
Table 3.1 Extensive Green Roof Material Specifications .....	33
Table 3.2 Ground Covers Appropriate for Green Roofs in the District of Columbia.....	35
Table 3.3 Typical Maintenance Activities Associated with Green Roofs .....	38
Table 3.4 Green Roof Design Performance .....	39
Table 3.5 Advantages and Disadvantages of Typical Cistern Materials (Source: Cabell Brand Center, 2007; Cabell Brand Center, 2009) .....	49
Table 3.6 Design Specifications for Rainwater Harvesting Systems.....	51
Table 3.7 Typical Maintenance Tasks for Rainwater Harvesting Systems.....	61
Table 3.8 Feasibility Criteria for Simple Disconnection .....	65
Table 3.9 Design Criteria for Disconnection to Small-scale Infiltration .....	68
Table 3.10 Design Criteria for Disconnection to Small-scale Bioretention (D-5).....	69
Table 3.11 Recommended Vegetation for Pervious Disconnection Areas .....	70
Table 3.12 Disconnection Retention Value and Pollutant Removal.....	72
Table 3.13 Permeable Pavement Specifications for a Variety of Typical Surface Materials .....	81
Table 3.14 Material Specifications for Typical Layers Beneath the Pavement Surface.....	81
Table 3.15 Typical Maintenance Tasks for Permeable Pavement Practices.....	90
Table 3.16 Enhanced Permeable Pavement Retention Value and Pollutant Removal.....	92
Table 3.17 Standard Permeable Pavement Retention Value and Pollutant Removal .....	92
Table 3.18 Maximum Contributing Drainage Area to Bioretention .....	97
Table 3.19 Sand Sizing Criteria .....	103
Table 3.20 Filter Media Criteria for Bioretention.....	104
Table 3.21 Determining Maximum Filter Media Depth (feet) .....	105
Table 3.22 Bioretention Material Specifications .....	107
Table 3.23 Herbaceous Plants Appropriate for Bioretention Areas in the District.....	113
Table 3.24 Woody Plants Appropriate for Bioretention Areas in the District.....	114
Table 3.25 Typical Maintenance Tasks for Bioretention Practices .....	118
Table 3.26 Enhanced Bioretention Retention Value and Pollutant Removal .....	120
Table 3.27 Standard Bioretention Design Retention Value and Pollutant Removal .....	120
Table 3.28 Filtering Practice Material Specifications.....	137
Table 3.29 Typical Annual Maintenance Activities for Filtering Practices.....	140
Table 3.30 Filter Retention Value and Pollutant Removal .....	142
Table 3.31 Infiltration Material Specifications .....	150
Table 3.32 Maximum Facility Depth for Infiltration Practices.....	151
Table 3.33 Typical Maintenance Activities for Infiltration Practices.....	155
Table 3.34 Infiltration Retention Value and Pollutant Removal.....	156
Table 3.35 Typical Check Dam Spacing to Achieve Effective Channel Slope .....	165
Table 3.36 Grass Channel Material Specifications .....	167
Table 3.37 Dry Swale Material Specifications .....	167
Table 3.38 Recommended Vegetation for Open Channels.....	172
Table 3.39 Typical Maintenance Activities and Schedule for Open Channels.....	175
Table 3.40 Grass Channel Retention Value and Pollutant Removal .....	176
Table 3.41 Grass Channel on Amended Soils Retention Value and Pollutant Removal .....	176
Table 3.42 Dry Swale Retention Value and Pollutant Removal .....	177
Table 3.43 Wet Swale Retention Value and Pollutant Removal .....	177
Table 3.44 Clay Liner Specifications.....	187
Table 3.45 Pond Maintenance Tasks and Frequency.....	193

Table 3.46	Pond Retention Value and Pollutant Removal.....	194
Table 3.47	Popular, Versatile, and Available Native Trees and Shrubs for Constructed Wetlands .....	208
Table 3.48	Popular, Versatile, and Available Native Emergent and Submergent Vegetation for Constructed Wetlands .....	209
Table 3.49	Wetland Retention Value and Pollutant Removal .....	212
Table 3.50	Typical Maintenance Activities for Storage Practices .....	224
Table 3.51	Storage Retention Value and Pollutant Removal.....	225
Table 3.52	Selecting Priority Trees and Forests for Conservation .....	229
Table 3.53	Methods for Addressing Urban Planting Constraints .....	231
Table 3.54	Tree Planting Techniques .....	232
Table 3.55	Preserved Tree Retention Value and Pollutant Removal.....	236
Table 3.56	Planted Tree Retention Value and Pollutant Removal.....	237
Table 4.1	BMP Selection Based on Regulatory Goals .....	243
Table 4.2	BMP Selection Based on Land Use Screening Factors .....	244
Table 4.3	Infiltration Design Choices Based on Measured Infiltration Rate* .....	246
Table 4.4	Physical Feasibility Screening Factors .....	246
Table 4.5	Community and Environmental Factors .....	249
Table 4.6	Location and Permitting Considerations.....	251
Table 5.1	DCMR Chapter 5 of Title 2 501.4, Table 2. Fees for Stormwater Management Plan Review	262
Table 5.2	DCMR Chapter 5 of Title 2 501.5, Table 3. Additional Fees.....	262
Table 5.3	DCMR Chapter 5 of Title 2 501.6, Table 4. Fees for Review of Stormwater Management Plan to Certify Stormwater Retention Credits.....	263
Table 5.4	DCMR Chapter 5 of Title 2 501.7, Table 5. Fees for Review of Green Area Ratio Plan.....	263
Table A.1	Land Cover Guidance for General Retention Compliance Calculator, consult Appendix O for more details.....	A-3
Table B.1	Roadway Classification and Extent Relative to Total Roadway System .....	B-4
Table B.2	Potential BMPs for Green Streets Projects (modified US EPA).....	B-14
Table B.3	Projects: MEP Submission Elements and Review Points .....	B-15
Table F.1	Manning’s Roughness Coefficient (n) Values for Various Channel Materials .....	F-1
Table F.2	Minimum Structure Loss to Use in Hydraulic Grade Line Calculation .....	F-3
Table H.1	Runoff Coefficient Factors for Typical District of Columbia Land Uses.....	H-6
Table K.1	Method to Determine Compost and Incorporation Depths .....	K-2
Table N.1	Likelihood Exposure will Occur .....	N-4
Table N.2	Magnitude of Health Risk .....	N-4
Table N.3	Characterizing Threat to Public Health.....	N-4
Table N.4	Chemicals of Interest for Baseline Investigations.....	N-10
Table N.5	Types of Stormwater Use and Routes of Exposure .....	N-11
Table N.6	Exposure Assumptions Based on Stormwater Use and Exposure Conditions.....	N-13
Table N.7	Categorizing Exposures Based on Stormwater Use: Severe, High, Medium, and Low .....	N-14
Table N.8	Risk-based Chemical Concentrations for Sites Categorized as Severe, High, Medium, and Low Exposures.....	N-16
Table N.9	Risk-Based Microbial Levels for Sites Categorized As Severe, High, Medium, and Low Exposures.....	N-18
Table P.1	Number of Infiltration Tests Required per BMP .....	P-2



## List of Figures

Figure 1.1	Changes in the water balance resulting from urbanization (FISRWG, 1998).	3
Figure 1.2	Changes in streamflow resulting from urbanization (Schueler, 1987).	3
Figure 2.1	Map of Anacostia Waterfront Development Zone.	9
Figure 2.2	Map of District of Columbia MS4 and combined sewer areas.	12
Figure 2.3	Determining the regulatory event used to calculate the SWRV.	15
Figure 2.4	Determining if overall retention requirements have been met, outside the AWDZ.	16
Figure 2.5	Determining if overall retention and water quality treatment requirements have been met, inside the AWDZ for regulated activity governed by the Anacostia Waterfront Environmental Standards Amendment Act of 2012.	17
Figure 2.6	Determining if minimum retention and water quality treatment requirements have been met.	18
Figure 2.7	Determining retention and water quality requirements for projects in the existing public right-of-way (PROW).	19
Figure 3.1	Typical layers for a green roof. (Note: the relative placement of various layers may vary depending on the type and design of the green roof system).	30
Figure 3.2	Example of a rainwater harvesting system detail.	42
Figure 3.3	Diagram of a first flush diverter. (TWRB, 2005)	47
Figure 3.4	Diagram of a roof washer. (TWRB, 2005)	47
Figure 3.5	Tank Design 1: Storage associated with the design storm volume only.	52
Figure 3.6	Tank Design 2: Storage associated with design storm, channel protection, and flood volume.	53
Figure 3.7	Tank Design 3: Constant drawdown version where storage is associated with design storm, channel protection, and flood volume.	53
Figure 3.8	Incremental design volumes associated with tank sizing.	55
Figure 3.9	Example of percent demand met versus cistern storage.	57
Figure 3.10	Example of retention value percentage achieved versus storage for non-potable uses.	58
Figure 3.11	Roof disconnection with alternative retention practices.	64
Figure 3.12	Demonstration sites exist throughout the District to promote downspout disconnection, removing impervious pavement, and promoting native plants.	68
Figure 3.13	Cross section of a standard permeable pavement design.	74
Figure 3.14	Cross section of an enhanced permeable pavement design with an underdrain.	75
Figure 3.15	Cross section of an enhanced standard permeable pavement design without an underdrain.	75
Figure 3.16	Use of flow barriers to encourage infiltration on sloped sites.	78
Figure 3.17	Example of standard bioretention design.	95
Figure 3.18	Example of an enhanced bioretention design with an underdrain and infiltration sump/storage layer.	95
Figure 3.19	Example of enhanced bioretention design without an underdrain.	96
Figure 3.20	Example of a stormwater planter (B-4).	110
Figure 3.21	Typical schematic for a surface sand filter (F-2).	124
Figure 3.22	Example of a three-chamber underground sand filter (F-3) for separate sewer areas. Note: Material specifications are indicated in Table 3.28.	125
Figure 3.23	Example of a three-chamber underground sand filter (F-3) for separate sewer areas. Note: Material specifications are indicated in Table 3.28.	126
Figure 3.24	Example of a three-chamber underground sand filter (F-3) for separate sewer areas. Note: Material specifications are indicated in Table 3.28.	127
Figure 3.25	Example of a three-chamber underground sand filter (F-3) for combined sewer areas. Note: Material specifications are indicated in Table 3.28.	128
Figure 3.26	Example of a three-chamber underground sand filter (F-3) for combined sewer areas. Note: Material specifications are indicated in Table 3.28.	129

Figure 3.27 Example of a three-chamber underground sand filter (F-3) for combined sewer areas. Note: Material specifications are indicated in Table 3.28. ....	130
Figure 3.28 Example of a perimeter sand filter (F-4). Note: Material specifications are indicated in Table 3.28. ....	131
Figure 3.29 Example of an infiltration trench. ....	143
Figure 3.30 Infiltration section with supplemental pipe storage. ....	144
Figure 3.31 Example of an infiltration basin. ....	145
Figure 3.32 Grass channel typical plan, profile, and section views (O-1). ....	158
Figure 3.33 Example of a dry swale (O-2). ....	159
Figure 3.34 Example of a wet swale (O-3). ....	160
Figure 3.35 Design schematics for a wet pond (P-2). ....	180
Figure 3.36 Typical extended detention pond (P-3) details. ....	181
Figure 3.37 Example of extended detention shallow wetland. ....	197
Figure 3.38 Cross section of a typical stormwater wetland. ....	198
Figure 3.39 Interior wetland zones: (I) Deep Pool (depth -48 to -18 inches), (II) Transition Zone (depth -18 to -6 inches), (III and IV) High Marsh Zone (depth -6 to +6 inches), (IV) Temporary Inundation Area, and (V) Upper Bank (adapted from Hunt et al, 2007). ....	198
Figure 3.40 Example of an underground detention vault and/or tank (S-1). ....	215
Figure 3.41 Example of a dry detention pond (S-2). ....	216
Figure 3.42 Tree planting guidelines. (Adapted from Flott, 2004 and ISA, 2003b). ....	233
Figure 3.43 The specifications for planting on a steep slope, require creating a level planting surface. ....	234
Figure 5.1 Stormwater Management and Soil Erosion and Sediment Control Plan Review, Steps 1 and 2. ....	282
Figure 5.2 Stormwater Management and Soil Erosion and Sediment Control Plan Review, Step 3. ....	283
Figure 5.3 Stormwater Management and Soil Erosion and Sediment Control Plan Review, Step 4. ....	284
Figure 5.4 Stormwater Management and Soil Erosion and Sediment Control Plan Review, Step 5. ....	285
Figure 7.1 Retention volume eligible to earn SRCs. ....	293
Figure B.1 Diagram of typical residential public right-of-way in the District of Columbia (DDOT Public Realm Design Manual 2011). ....	B-2
Figure F.1 Typical nomograph for culverts under outlet control. ....	F-8
Figure G.1 Absolute downstream control of flow under gate. ....	G-2
Figure H.1 Approximate detention basin routing for rainfall types I, IA, II and III. ....	H-3
Figure I.1 Rooftop stormwater detention. ....	I-3
Figure I.2 Typical rainfall ponding ring sections. ....	I-4

## List of Equations

Equation 2.1 Stormwater Retention Volume .....	10
Equation 2.2 Water Quality Treatment Volume .....	13
Equation 3.1 Storage Volume for Green Roofs .....	34
Equation 3.2 Reservoir Layer or Infiltration Sump Depth.....	83
Equation 3.3 Drawdown Time.....	84
Equation 3.4 Permeable Pavement Storage Volume.....	84
Equation 3.5 Bioretention Storage Volume .....	111
Equation 3.6 Minimum Filter Surface Area for Filtering Practices.....	137
Equation 3.7 Required Ponding Volume for Filtering Practices.....	138
Equation 3.8 Storage Volume for Filtering Practices .....	138
Equation 3.9 Maximum Surface Basin Depth for Infiltration Basins.....	150
Equation 3.10 Maximum Underground Reservoir Depth for Infiltration Trenches .....	150
Equation 3.11 Surface Basin Surface Area for Infiltration Basins .....	151
Equation 3.12 Underground Reservoir Surface Area for Infiltration Trenches.....	152
Equation 3.13 Storage Volume Calculation for Surface Basin Area for Infiltration Basins.....	152
Equation 3.14 Storage Volume Calculation for Underground Reservoir Surface Area for Infiltration Trenches .....	152
Equation 3.15 Manning's Equation .....	169
Equation 3.16 Continuity Equation.....	170
Equation 3.17 Minimum Width .....	170
Equation 3.18 Corresponding Velocity.....	170
Equation 3.19 Grass Channel Length for Hydraulic Residence Time of 9 minutes (540 seconds).....	170
Equation 3.20 Grass Channel Storage Volume.....	171
Equation 3.21 Dry Swale Storage Volume .....	171
Equation 3.22 Wet Swale Storage Volume.....	172
Equation 3.23 Pond Storage Volume.....	189
Equation 3.24 Water Balance Equation for Acceptable Water Depth in a Wet Pond .....	190
Equation 3.25 Baseflow Conversion.....	190
Equation 3.26 Wetland Storage Volume.....	203
Equation 3.27 Water Balance for Acceptable Water Depth in a Stormwater Wetland.....	203
Equation 3.28 Minimum Depth of the Permanent Pool.....	204



# Chapter 1                      Introduction to the Stormwater Management Guidebook

## 1.1 Introduction

Inadequate management of increased stormwater runoff resulting from development places a burden on sewer systems and degrades the aquatic resources in waterbodies of the District of Columbia (District). By overloading the capacity of streams and storm sewers, unmanaged stormwater runoff is responsible for increased combined sewer overflow events and adverse downstream impacts such as flash flooding, channel erosion, surface and groundwater pollution, and habitat degradation.

Recognizing this, the District first adopted stormwater management regulations in 1988. These regulations (in chapter 5 of title 21 of the District of Columbia Municipal Regulations) established requirements to manage both stormwater quality and quantity. Quality control focused on the removal of pollutants from up to the first 0.5 inches of stormwater runoff, often referred to as the first flush. Quantity control came in the form of detention requirements based on the 2-year, 24-hour event for stream bank protection, as this is widely accepted as the channel shaping flow, and the 15-year, 24-hour event for flood protection, as this is the typical design capacity of the District of Columbia's sewer conveyance system.

The revisions to the 1988 regulations, on which this Stormwater Management Guidebook provides technical guidance, have not significantly changed the detention requirements, but the focus on water quality treatment has shifted to volume retention. Major land-disturbing activities must retain the volume from a 1.2-inch storm event, and major substantial improvement activities must retain the volume from a 0.8-inch storm event. By keeping stormwater on site, stormwater retention effectively provides both treatment and additional volume control, significantly improving protection for District waterbodies. This volume can be managed through runoff prevention (e.g., conservation of pervious cover or reforestation), runoff reduction (e.g., infiltration, water reuse), and runoff treatment (e.g., plant/soil filter systems, permeable pavement, etc.).

## 1.2 Purpose and Scope

The purpose of this Stormwater Management Guidebook (SWMG) is to provide the technical guidance required for compliance with the District's stormwater management regulations, including the criteria and specifications to be used by design engineers and planners for the planning, design, and construction of sites and Stormwater Best Management Practices (BMPs).

It is the responsibility of the design engineer to review, verify, and select the appropriate BMPs and materials for the specific project under design and to submit to DDOE, as required, all reports, design computations, worksheets, geotechnical studies, surveys, rights-of-way determinations, etc. All such required submittals will bear the seal and signature of the

Professional Engineer licensed to practice in the District who is responsible for that portion of the submitted project.

### **1.3 Impacts of Urban Runoff**

The collective impacts of the rooftops, sidewalks, roadways, and other impervious surfaces of an urban center, such as the District of Columbia, on streams and rivers have historically been divided into two categories. First, the hydrologic response of an urban area is changed. As drainage areas become increasingly impervious, stormwater runoff volumes, flows, and velocities increase, while base groundwater flows decrease. Small annual storm events that would be captured by the plants and soils of an undeveloped landscape are delivered quickly and efficiently to the receiving pipe network and streams in a city. Second, human activities in the city generate increased pollutant loads, ranging from heavy automobile traffic to use of various chemicals. These pollutants, as well as the deposition of atmospheric pollution from outside of the city, build up on impervious surfaces during dry weather, and rain and snow events wash these pollutants into the District's sewer pipes, streams, and rivers.

#### **1.3.1 Hydrologic Impacts**

Urban development causes significant changes in the rainfall-runoff relationship within a watershed. Rainfall volumes shift from evapotranspiration and infiltration to surface and piped runoff. This delivers large amounts of runoff to receiving pipes and streams for even the smallest rainfall event within an urban development (see Figure 1.1). A city represents a transformation from a natural catchment to a sewershed, through an increase in surface imperviousness and an underground piped conveyance system. Natural drainage patterns are modified and stormwater runoff is channeled through roof drains, pavement, road gutters, and storm drains. Direct connections between impervious surfaces and conveyance systems for stormwater meant to avoid flooding deliver these larger volumes more quickly. This leads to an increase in runoff volumes and velocities. The time taken for the runoff to travel downstream is shorter and infiltration into underlying soils and groundwater aquifers is decreased or eliminated (see Figure 1.2).

The stormwater management regulations established in 1988 responded to these volume impacts with a focus on ~~peak matching~~. Recent research finds the approach to delaying volume releases and releasing at a 2-year flow rate has, in many cases, led to an increase in stream erosion. Under this approach, the full runoff volume is still forced through the receiving channel. Even at the lower flow rate, the channel is subjected to an elevated flow (the 2-year flow rate in the District) for prolonged durations. In addition, the many storms that are smaller than the 2-year storm are allowed to wash off the site through the 2-year flow control structure at the same higher rate of discharge that would be allowed for the 2-year storm. Retention requirements complement peak flow matching by retaining stormwater from these smaller storms on-site and reducing the overall volumes that leave the site. This is a better approximation of the natural drainage cycle.

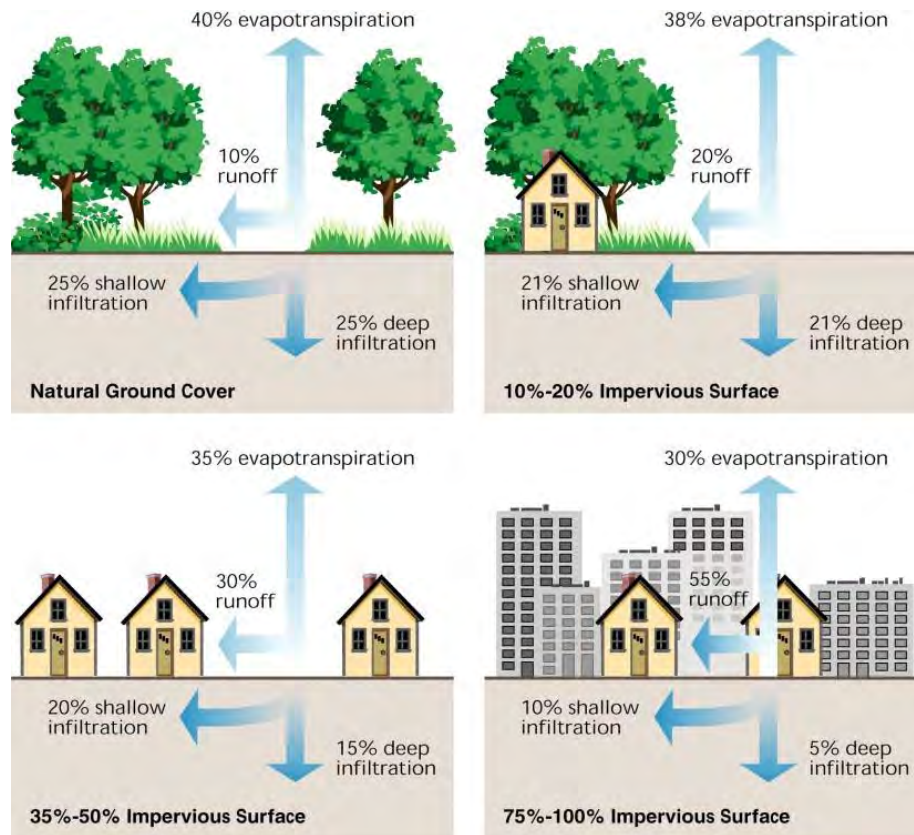


Figure 1.1 Changes in the water balance resulting from urbanization (FISRWG, 1998).

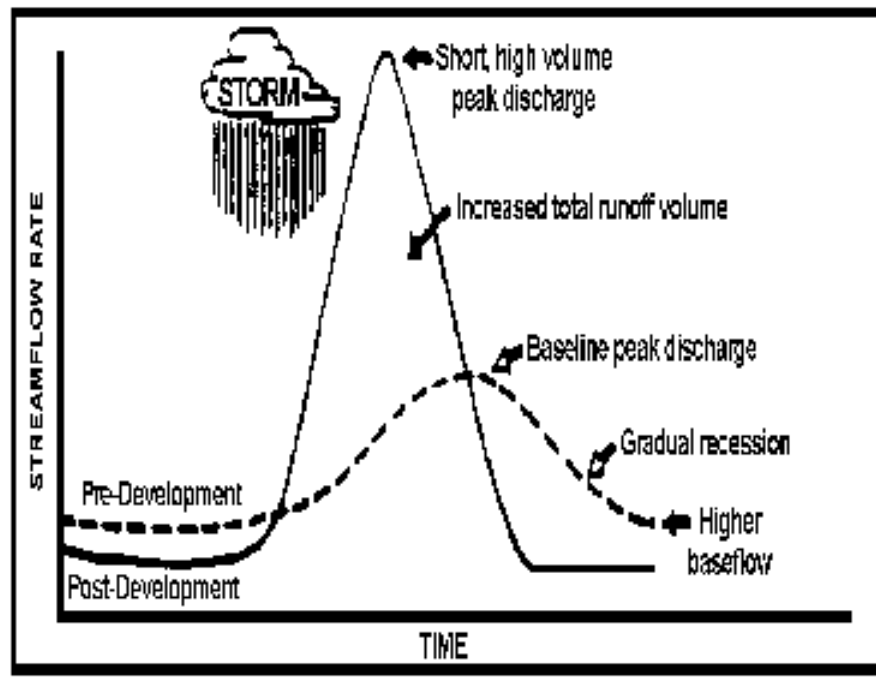


Figure 1.2 Changes in streamflow resulting from urbanization (Schueler, 1987).

### 1.3.2 Water Quality Impacts

As land is developed, naturally vegetated areas that once allowed water to infiltrate and purify itself in the soil are replaced with impervious surfaces. Approximately 43 percent of the District's natural groundcover has been replaced with impervious surface. These impervious surfaces accumulate pollutants deposited from the atmosphere, leaked from vehicles, or windblown from adjacent areas. During storm events, these pollutants quickly wash off and are rapidly delivered to downstream waters. Some common pollutants found in urban stormwater runoff and their sources are profiled in **Error! Reference source not found.**



**Table 1.1 Common Pollutants in Urban Stormwater Runoff and Their Sources (Municipal Handbook, State of California, 1993)**

Pollutant	Automobile/ Atmospheric Deposition	Urban Housekeeping / Landscaping Practices	Industrial Activities	Construction Activities	Non- Stormwater Connections	Accidental Spills and Illegal Dumping
Sediments	X	X	X	X		
Nutrients	X	X	X	X	X	X
Bacteria and Viruses	X	X		X	X	X
Oxygen Demanding Substances		X	X	X	X	X
Oil and Grease	X	X	X	X	X	X
Anti-Freeze	X	X		X	X	X
Hydraulic Fluid	X	X	X	X	X	X
Paint		X		X	X	X
Cleaners and Solvents	X	X	X	X	X	X
Wood Preservatives		X		X	X	X
Heavy Metals	X	X	X	X	X	X
Chromium	X	X	X			
Copper	X	X	X			
Lead	X	X	X			
Zinc	X	X	X			
Iron	X		X			
Cadmium	X		X			
Nickel	X		X			
Magnesium	X		X			
Toxic Materials						
Fuels	X		X	X	X	X
PCBs	X				X	X
Pesticides	X	X	X	X	X	X
Herbicides	X		X	X	X	X
Floatables		X	X	X		



# Chapter 2                    Minimum Control Requirements

## 2.1 District of Columbia Stormwater Management Performance Requirements

This chapter presents a unified approach for sizing stormwater best management practices (BMPs) in the District to meet pollutant removal goals, reduce peak discharges, and pass extreme floods. Table 2.1 presents a summary of the sizing criteria used to achieve the stormwater management performance requirements for regulated activity.

Those portions of regulated activity that involve the reconstruction of the existing public right-of-way are governed by a “maximum extent practicable” approach detailed in Appendix B. There are notes throughout this chapter that identify special conditions for regulated activity located in the Anacostia Waterfront Development Zone (AWDZ) that are governed by the Anacostia Waterfront Environmental Standards Amendment Act of 2012 (see D.C. Official Code §§ 2-1226.36(c)(1)). Figure 2,1 provides a map that outlines the boundaries of the Anacostia Waterfront Development Zone and the exact boundaries are provided in definitions found Appendix V.

This chapter describes the five sizing criteria in detail and provides guidance on how to properly compute and manage the required volumes. This chapter also presents an overview of acceptable BMP options that can be used to comply with the sizing criteria. Appendix A on compliance calculations provides a line-by-line review of the accompanying calculator spreadsheets.

Note: 2-yr post development peak discharge requirements do not apply to projects when three conditions can be established about the discharge from the site (1) site discharge flow directly to, or through the separate sewer system, into the main stem of the tidal Potomac or Anacostia Rivers, the Washington Channel, or the Chesapeake and Ohio Canal; (2) site discharges do not flow into or through a tributary to those waterbodies that runs above ground or that the Department expects to be daylighted to run above ground; and (3) site discharges will not cause erosion of land or transport of sediment.

**Table 2.1 Sizing Criteria for Stormwater Management Performance Requirements**

Sizing Criteria	Description of Stormwater Sizing Criteria
Stormwater Retention Volume (SWR <sub>v</sub> ) (gal)	$SWR_v = [P \times [(R_{vI} \times \%I) + (R_{vC} \times \%C) + (R_{vN} \times \%N)] \times SA] \times 7.48/12$ <p>where:</p> <p>SWR<sub>v</sub> = volume, in gallons, required to be retained onsite</p> <p>P = variable percentile rainfall event for the District dependent on regulatory trigger (see note below)</p> <p>R<sub>vI</sub> = 0.95 (runoff coefficient for impervious cover)</p> <p>R<sub>vC</sub> = 0.25 (runoff coefficient for compacted cover)</p> <p>R<sub>vN</sub> = 0.00 (runoff coefficient for natural cover)</p> <p>%I = percent of site in impervious cover (decimal)</p> <p>%C = percent of site in compacted cover (decimal)</p> <p>%N = percent of site in natural cover (decimal)</p> <p>SA = surface area (ft<sup>2</sup>)</p> <p>7.48 = conversion factor, converting cubic feet to gallons</p> <p>12 = conversion factor, converting inches to feet</p>
Precipitation value selected based on Regulatory Trigger (P)	<p>Major Land Disturbing Activity (AWDZ and District-wide): 90<sup>th</sup> percentile event (1.2 inches)</p> <p>Major Substantial Improvement (AWDZ): 85<sup>th</sup> percentile event (1.0 inches)</p> <p>Major Substantial Improvement Activity (District-wide): 80<sup>th</sup> percentile event (0.8 inches)</p>
Reconstruction of public right-of-way	<p style="text-align: center;"><b>Consult Appendix B.</b></p> <p style="text-align: center;"><b>Maximum Extent Practicable Process for Existing Public Right-of-Way</b></p>
Water Quality Treatment Volume (WQT <sub>v</sub> ) (gal)  (applies only to regulated activity in the AWDZ area governed by the Anacostia Waterfront Environmental Standards Amendment Act of 2012)	$WQT_v = ([P \times [(R_{vI} \times \%I) + (R_{vC} \times \%C) + (R_{vN} \times \%N)] \times SA] \times 7.48/12) - SWR_v$ <p>where:</p> <p>WQT<sub>v</sub> = volume, in gallons, required to be retained or treated, above and beyond the SWR<sub>v</sub></p> <p>SWR<sub>v</sub> = volume, in gallons, required to be retained onsite</p> <p>P = 95<sup>th</sup> percentile rain event for the District (1.7 inches)</p> <p>R<sub>vI</sub> = 0.95 (runoff coefficient for impervious cover)</p> <p>R<sub>vC</sub> = 0.25 (runoff coefficient for compacted cover)</p> <p>R<sub>vN</sub> = 0.00 (runoff coefficient for natural cover)</p> <p>%I = percent of site in impervious cover (decimal)</p> <p>%C = percent of site in compacted cover (decimal)</p> <p>%N = percent of site in natural cover (decimal)</p> <p>SA = surface area (ft<sup>2</sup>)</p> <p>7.48 = conversion factor, converting cubic feet to gallons</p> <p>12 = conversion factor, converting inches to feet</p>
2-Year Storm Control (Q <sub>p2</sub> )	The peak discharge rate from the 2-year, 24-hour storm event controlled to the pre-development peak discharge rate.
15-Year Storm Control (Q <sub>p15</sub> )	The peak discharge rate from the 15-year, 24-hour storm event controlled to the pre-project peak discharge rate.
Extreme Flood Requirements (Q <sub>f</sub> )	<p>The peak discharge rate from the 100-year storm event controlled to the pre-project peak discharge rate if the site:</p> <ol style="list-style-type: none"> <li>1) Increases the size of a Special Flood Hazard Area (SFHA) as delineated on the effective Flood Insurance Rate Maps (FIRM) or</li> <li>2) Meets the following two conditions: <ol style="list-style-type: none"> <li>(a) Does not discharge to the sewer system and</li> <li>(b) Has a post-development peak discharge rate for a 100-year frequency storm event that will cause flooding to a building.</li> </ol> </li> </ol>

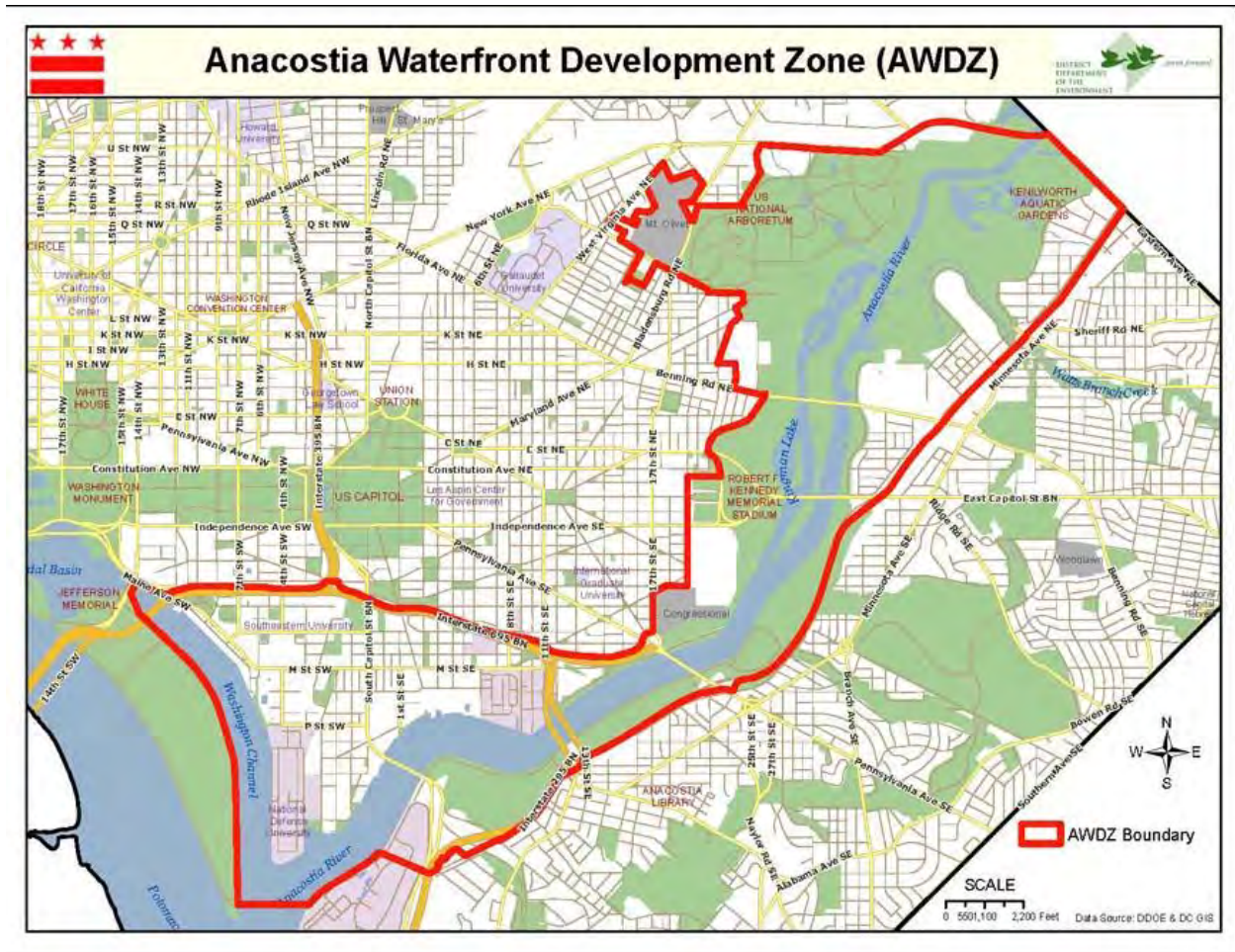


Figure 2.1 Map of Anacostia Waterfront Development Zone.

## 2.2 Stormwater Retention Volume

Sites that undergo a major activity that qualifies as a regulated event, either a major land-disturbing activity or a major substantial improvement activity, shall employ BMPs and post-development land cover necessary to achieve the retention of the Stormwater Retention Volume (SWRV) equal to the post-development runoff from the applicable rainfall event, measure for a 24-hour storm with a 72-hour antecedent dry period. For a major substantial improvement activity located in the Anacostia Waterfront Development Zone (AWDZ), governed by the Anacostia Waterfront Environmental Standards Amendment Act of 2012, the applicable rainfall event is the 85th percentile rainfall event (1.0 inches). For all other major substantial improvement activities throughout the District of Columbia, the applicable rainfall event is the 80th percentile rainfall event (0.8 inches). The SWRV is calculated as follows for the entire site and for each drainage area:

**Equation 2.1 Stormwater Retention Volume**

$$SWR_v = \frac{\{P \times [(Rv_I \times \%I) + (Rv_C \times \%C) + (Rv_N \times \%N)] \times SA\} \times 7.48}{12}$$

where:

SWR <sub>v</sub>	=	volume required to be retained onsite (gal)
P	=	selection of District rainfall event varies based on regulatory trigger; 90th percentile (1.2 inches) for major land-disturbing activity, 85th percentile (1.0 inches) for major substantial improvement activity in the AWDZ and governed by the Anacostia Waterfront Environmental Standards Amendment Act of 2012, 80th percentile (0.8 inches) for other major substantial improvement activities
R <sub>vI</sub>	=	runoff coefficient for impervious cover (0.95)
%I	=	percent of site in impervious cover
R <sub>vC</sub>	=	runoff coefficient for compacted cover (0.25)
%C	=	percent of site in compacted cover
R <sub>vN</sub>	=	runoff coefficient for natural cover (0.00)
%N	=	percent of site in natural cover
SA	=	surface area (ft <sup>2</sup> )
7.48	=	conversion factor, converting cubic feet to gallons
12	=	conversion factor, converting inches to feet

where the surface area under a BMP shall be calculated as part of the impervious cover (%I); and

A site may achieve on-site retention by directly conveying volume from the regulated site to a shared BMP with available retention capacity. A site may achieve the SWRV on-site or through a combination of on-site retention and off-site retention under the following conditions:

- The site shall retain on-site a minimum of 50 percent of the SWRV calculated for the entire site, unless DDOE approves an application for relief from extraordinarily difficult site conditions (Appendix E).
- The site shall use off-site retention for the portion of the SWRV that is not retained on-site (See Chapter 6 and Appendix C).
- Regulated activity in the AWDZ, governed by the Anacostia Waterfront Environmental Standards Amendment Act of 2012, must have all off-site retention approved by DDOE even if the minimum 50 percent on-site requirement has been achieved. These projects may apply to achieve retention compliance with off-site retention based on considerations of technical infeasibility and environmental harm as well as the limited appropriateness of on-site compliance in terms of impact on surrounding landowners or overall benefit to District waterbodies.
- Projects requesting relief from compliance with the minimum on-site retention obligation (50% of the SWRV) and claiming “extraordinarily difficult site conditions” and will follow the submission and evaluation process in Appendix E. Sites approved for relief from

extraordinarily difficult site conditions” are still responsible for the entire SWR<sub>v</sub> but will be allowed to use off-site retention to achieve more than 50% of the SWR<sub>v</sub>.

An individual drainage area is defined as the area that drains to a single discharge point from the site. A site may achieve on-site retention by retaining more than the SWR<sub>v</sub> in a drainage area, subject to the following conditions:

- For each drainage area, as well as for all vehicular access areas within each drainage area, at least 50 percent of the SWR<sub>v</sub> shall be retained or treated to remove 80 percent of total suspended solids (TSS) with an accepted practice, unless it drains into the combined sewer system. For vehicular access areas, that are part of a submission following the Maximum Extent Practicable (MEP), the MEP narrative must address the placement and sizing opportunities, and restrictions, of retention practice if these minimums are not achieved. Figure 2.2 provides a map that outlines the boundaries of the District’s Combined Sewer System (CSS) and Municipal Separate Storm Sewer System (MS4).
- Retention in excess of the SWR<sub>v</sub> for one drainage area may be applied to the retention volume required for another drainage area;
- Retention of volume greater than that from a 1.7-inch rainfall event, calculated using the SWR<sub>v</sub> equation with a P equal to 1.7 inches, shall not be counted toward on-site retention.

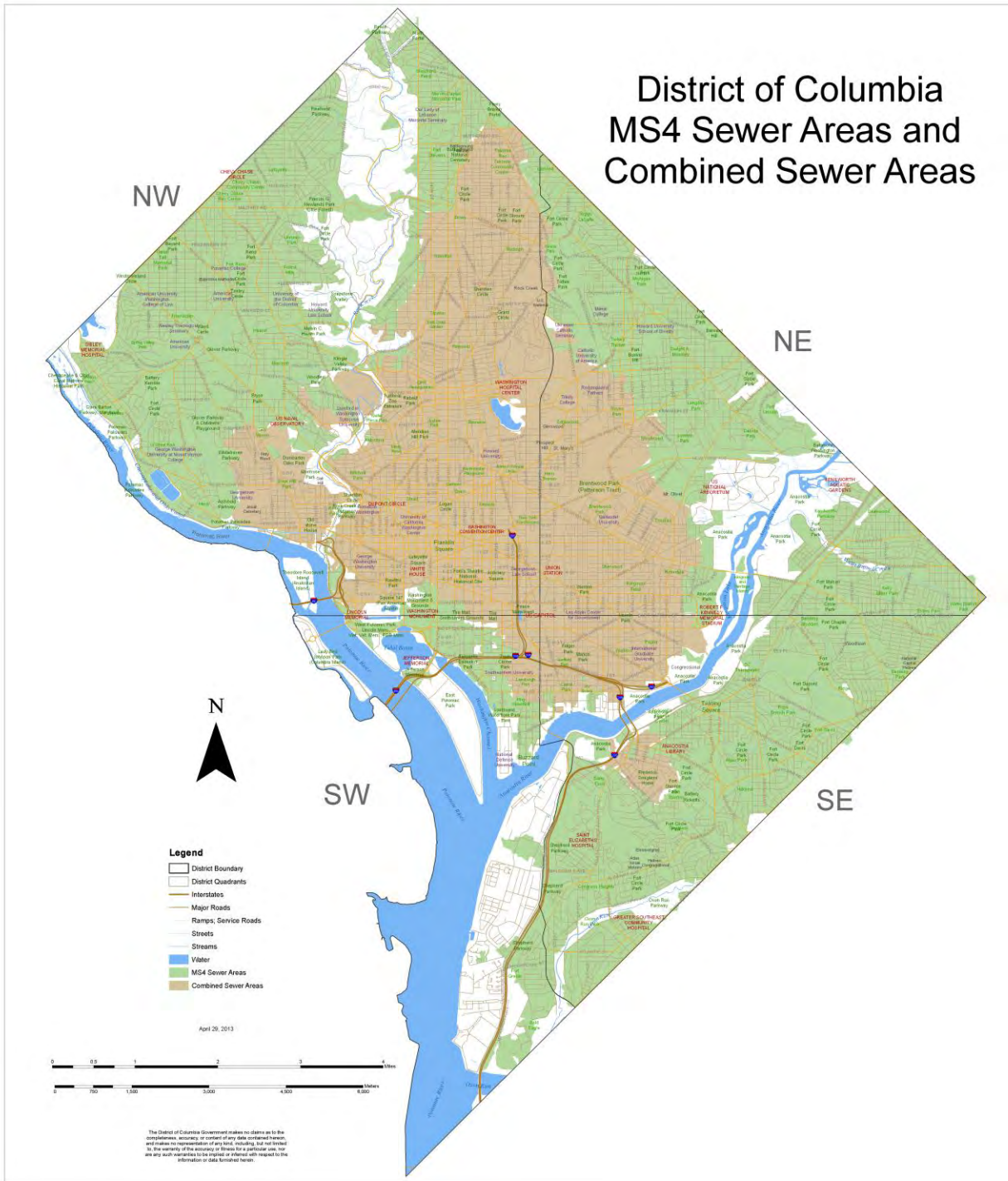


Figure 2.2 Map of District of Columbia MS4 and combined sewer areas.



Practices accepted by DDOE for treatment to remove 80 percent of TSS include the following:

- Permeable Pavement
- Bioretention
- Stormwater Filtering System
- Stormwater Ponds
- Wetland
- Dry Swale
- Wet Swale

Proprietary Practices that have been demonstrated to achieve an 80% reduction in TSS in accordance with the requirements of Appendix T.

Major land-disturbing activities in the existing public right-of-way (PROW), including activities associated with a major land-disturbing activity on private property, must achieve the SWR<sub>v</sub> to the maximum extent practicable (MEP). The MEP design and review process is detailed in Appendix B.

### 2.3 Water Quality Treatment Volume

In addition to the SWR<sub>v</sub> requirements above, sites located in the AWDZ and governed by the *Anacostia Waterfront Environmental Standards Amendment Act of 2012* shall employ BMPs and post-development land cover necessary to achieve a water quality treatment volume (WQTV) equal to the difference between the post-development runoff from the 95th percentile rainfall event (1.7 inches), measured for a twenty-four (24)-hour rainfall event with a 72-hour antecedent dry period; and the SWR<sub>v</sub>. The WQTV is calculated as follows, for the entire site, and each drainage area:

#### Equation 2.2 Water Quality Treatment Volume

$$WQTV = \{P \times [(Rv_I \times \%I) + (Rv_C \times \%C) + (Rv_N \times \%N)] \times SA\} \times 7.48 - SWRv$$

where:

- WQTV = volume, in gallons, required to be retained or treated, above and beyond the stormwater retention volume (SWR<sub>v</sub>).
- SWR<sub>v</sub> = volume, in gallons, required to be retained, as described in Section 2.2
- P = 95th percentile rainfall event for the District (1.7 inches)
- Rv<sub>I</sub> = 0.95 (runoff coefficient for impervious cover)
- Rv<sub>C</sub> = 0.25 (runoff coefficient for compacted cover)
- Rv<sub>N</sub> = 0.00 (runoff coefficient for natural cover)
- %I = percent of site in impervious cover
- %C = percent of site in compacted cover
- %N = percent of site in natural cover
- SA = surface area in square feet,

where, the surface area under a BMP shall be calculated as part of the impervious cover (%I); and

A site in the AWDZ that is governed by the Anacostia Waterfront Environmental Standards Amendment Act of 2012 may achieve on-site treatment for WQTV with:

- On-site treatment with an accepted treatment practice designed to remove 80 percent of Total Suspended Solids (TSS);
- On-site retention; or
- Direct conveyance of stormwater from the site to an approved shared BMP with sufficient available treatment or retention capacity.

An AWDZ site that is governed by the Anacostia Waterfront Environmental Standards Amendment Act of 2012 may achieve part of the WQTV by using off-site retention if site conditions make compliance technically infeasible or environmentally harmful and DDOE approves an application for relief from extraordinarily difficult site conditions.

An AWDZ site governed by the Anacostia Waterfront Environmental Standards Amendment Act of 2012 that achieves 1 gallon of Off-Site Retention Volume (Offv) by using Stormwater Retention Credits (SRCs) certified for retention capacity located outside of the Anacostia watershed shall use 1.25 SRCs for that gallon of Offv.

Figures 2.1–2.5 below describe the relationship between a variety of project types, the SWRV and the WQTV.

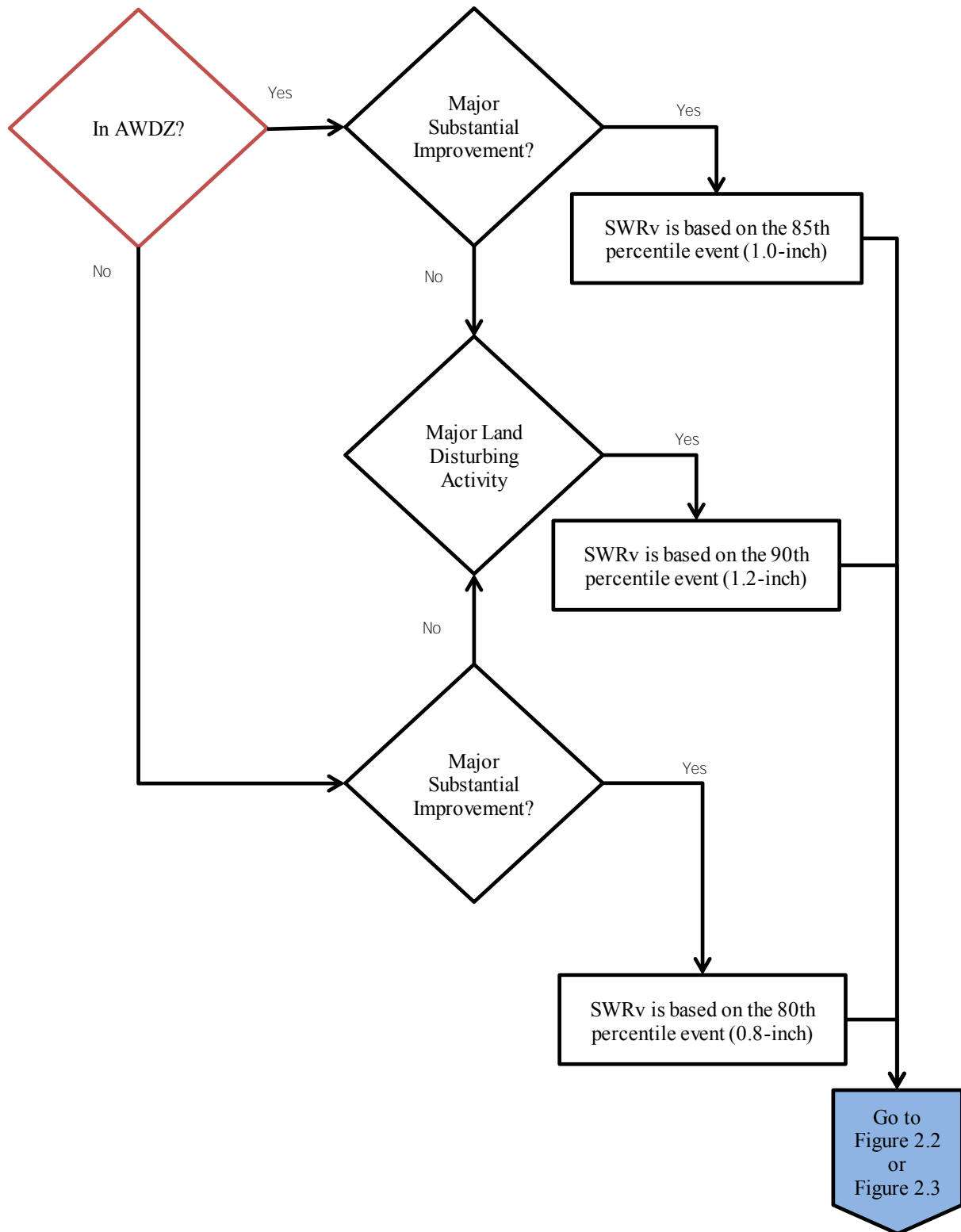


Figure 2.3 Determining the regulatory event used to calculate the SWRV.

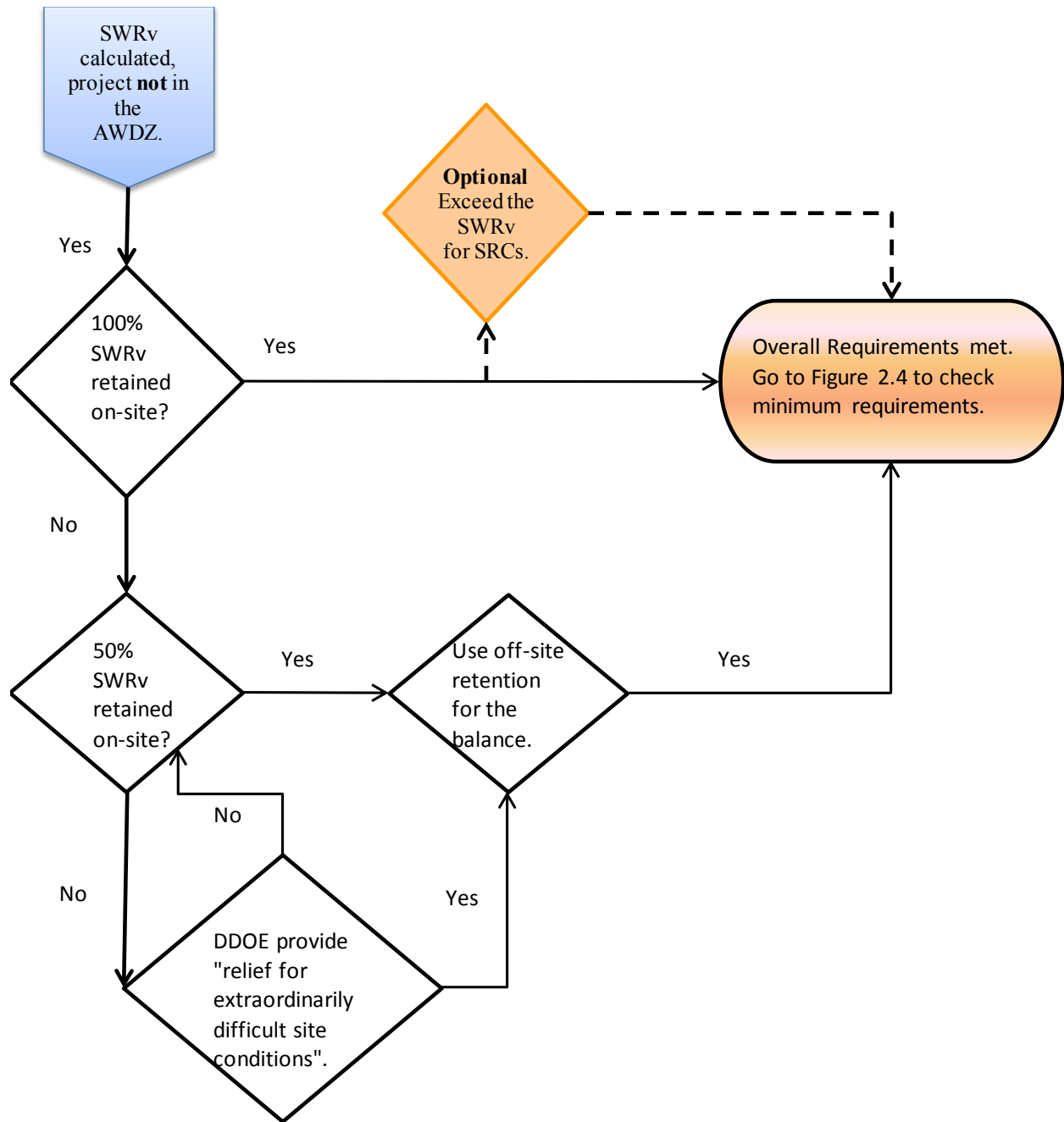
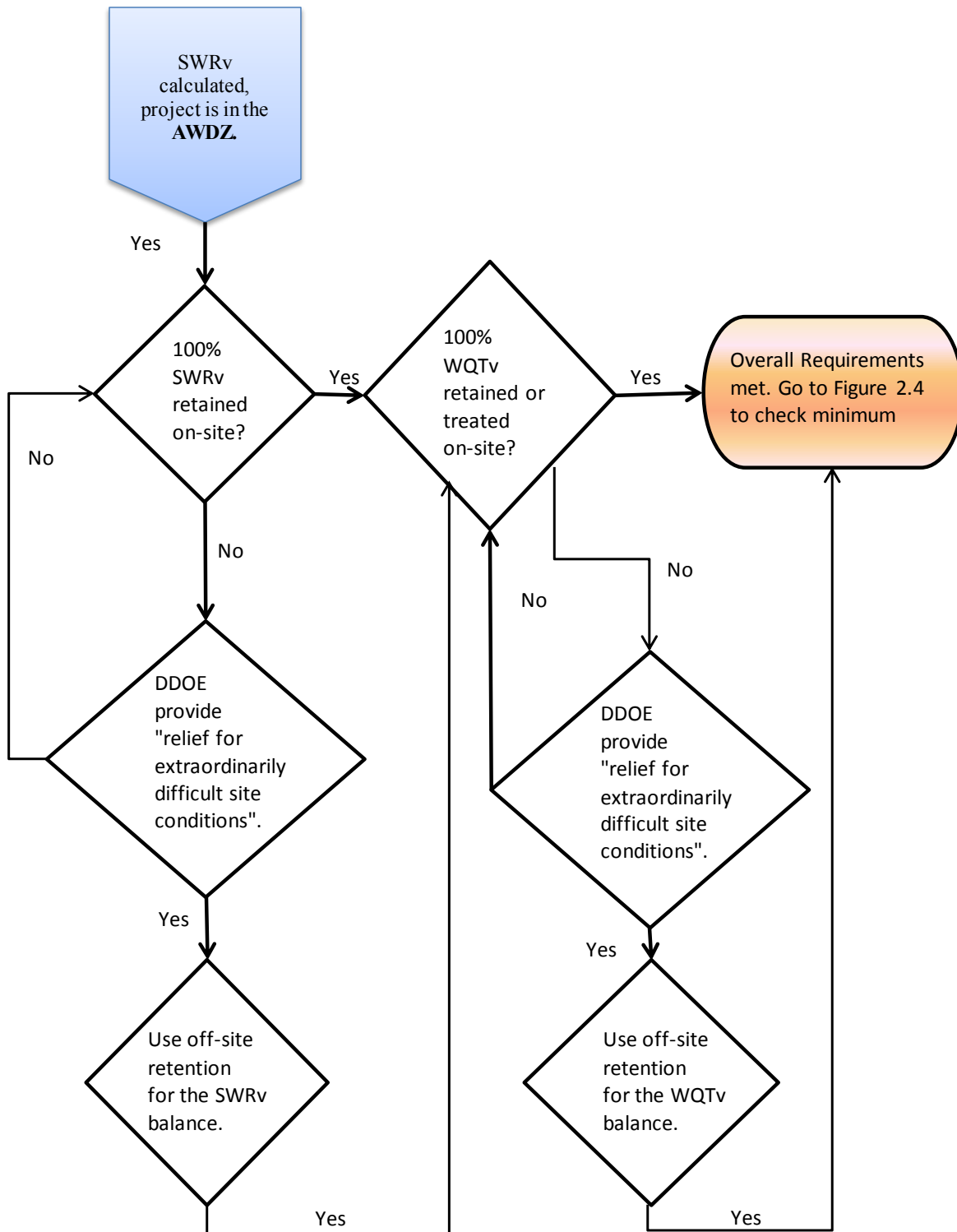
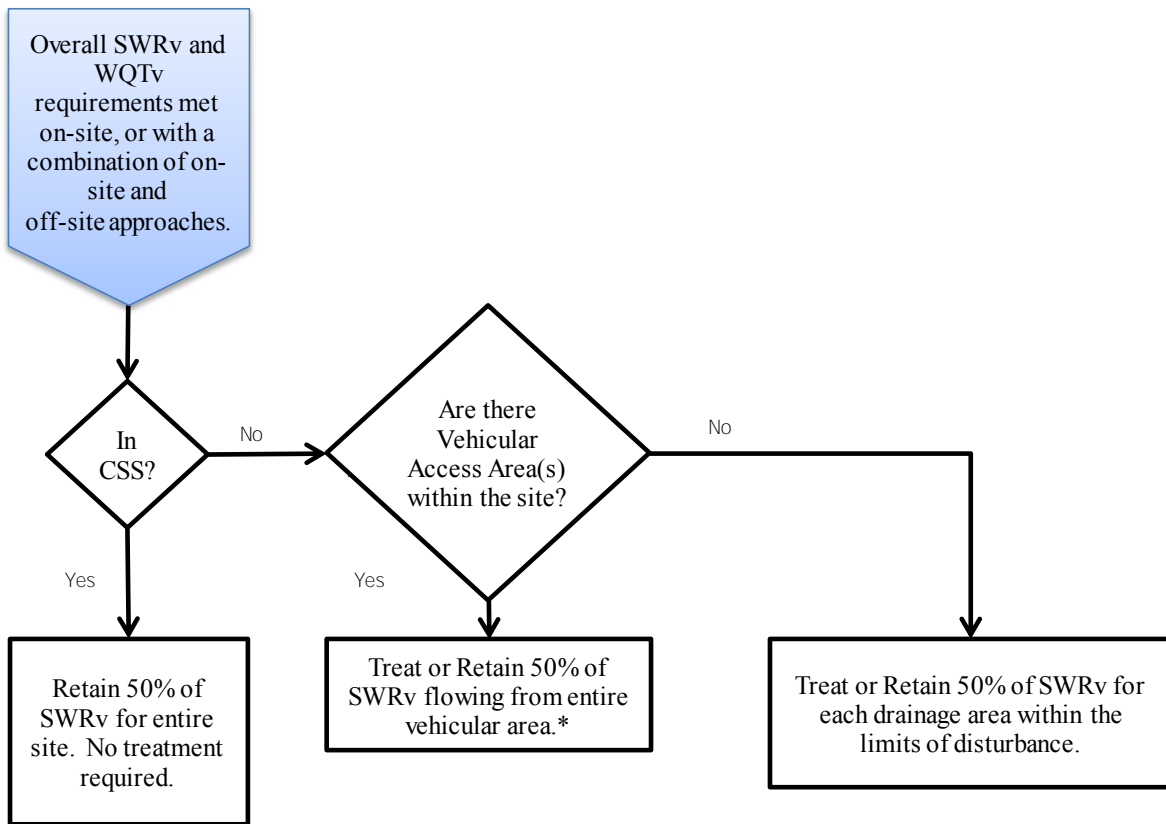


Figure 2.4 Determining if overall retention requirements have been met, outside the AWDZ.

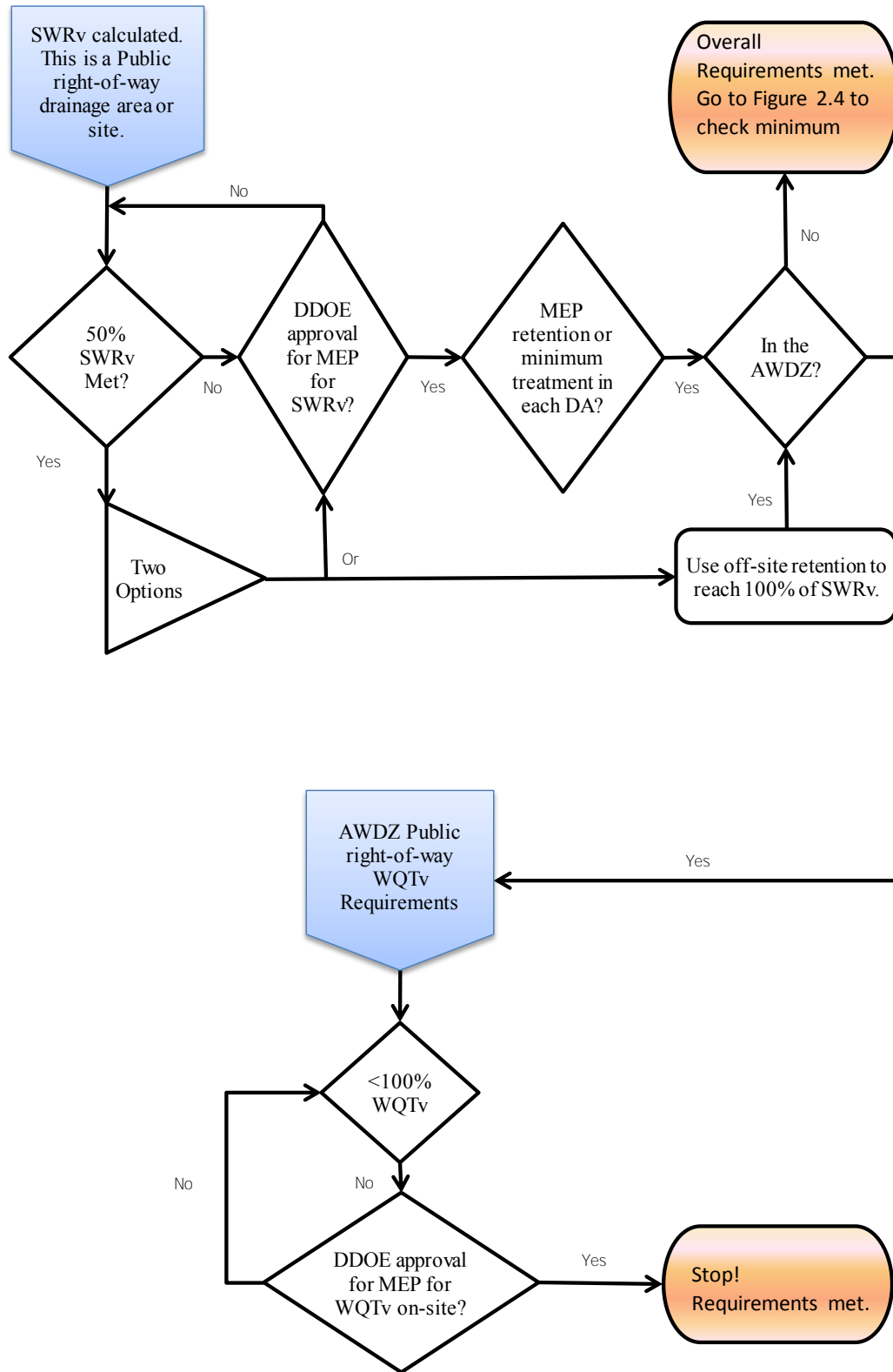


**Figure 2.5 Determining if overall retention and water quality treatment requirements have been met, inside the AWDZ for regulated activity governed by the Anacostia Waterfront Environmental Standards Amendment Act of 2012.**



\* Existing Public right-of-way (PROW) sites follow these guidelines to the maximum extent practicable (MEP). The MEP design and review process is detailed in Appendix B.

**Figure 2.6 Determining if minimum retention and water quality treatment requirements have been met.**



**Figure 2.7** Determining retention and water quality requirements for projects in the existing public right-of-way (PROW).

## 2.4 Extreme Flood Requirements (Qf)

To meet the extreme flood requirements, a site shall maintain the peak discharge rate from the 100-year storm event controlled to the pre-project peak discharge rate if the site:

1. Increases the size of a Special Flood Hazard Area (SFHA) as delineated on the effective Flood Insurance Rate Maps (FIRM) or
2. Meets the following two conditions:
  - (a) Does not discharge to the sewer system and
  - (b) Has a post-development peak discharge rate for a 100-year-frequency storm event that will cause flooding to a building.

The intent of the extreme flood criteria is to (a) prevent flood damage from large storm events, and (b) maintain the boundaries of the 100-year Federal Emergency Management Agency (FEMA) floodplain.

In general, stormwater runoff leaving a development site shall be discharged directly into an adequate natural or man-made receiving channel, pipe or storm sewer system or the applicant shall provide a drainage system satisfactory to DDOE to preclude an adverse impact (e.g., soil erosion, sedimentation, flooding, duration of ponding water, inadequate overland relief) on downstream properties and receiving systems. If the applicant chooses to install a drainage system, the system shall be designed in accordance with established, applicable criteria for such systems.

Stormwater runoff leaving a development site where it does not discharge directly to the sewer system shall not aggravate or create a condition where an existing building is flooded from the 100-year storm event. If such a condition exists, on-site detention for the 100-year storm event shall be provided.

In situations where the size of the Special Flood Hazard Area (SFHA) as delineated on the effective Flood Insurance Rate Map (FIRM) by the Federal Emergency Management Agency (FEMA) will be increased based on the increased post-development 100-year discharge, the post-development 100-year peak discharge shall be maintained at a level that is equal to or less than the pre-project 100-year peak discharge.

## 2.5 Minimum Criteria for Determining Extreme Flood Requirements

It is recommended that an applicant use the District's online Flood Zone Determination Tool (available at <http://ddoe.dc.gov/floodplainmap>) as an initial screening for this section.

In order to determine whether extreme flood requirements are applicable, an applicant shall be conducted in accordance with the following minimum criteria.



**Downstream Analysis:**

1. Consult DDOE to initially determine whether or not the downstream analysis is needed. Site visit is necessary for the determination. This analysis is used to determine the impact of the 100-year post development discharge on a building.
2. If the analysis is needed, the analysis shall contain supporting computations as justification for the conclusions contained in the analysis. For consistency, the following items are to be included at a minimum:
  - (a) Site-specific narrative with a description of the elements of the storm drainage system, overland relief paths and adjoining properties;
  - (b) A drainage plan showing outfall location(s) with the contributing drainage areas for each outfall. Digital pictures of the outfall shall be included;
  - (c) A profile for each outfall channel and overland relief path;
  - (d) Two cross sections, at a minimum, at each critical location to verify the outfall and overland relief adequacy. Cross sections shall be based on a 2-foot contour interval and additional spot elevations in the vicinity. The cross sections shall have the same vertical and horizontal scales and shall identify the top of banks for the channel;
  - (e) Description of the outfall channel and permissible velocity. The Manning's roughness coefficient shall be supported by soil classification, cover material, and channel's or flow path's lining. The description of physical characteristics may include the amount of flow meandering, material classification of the flow path and its banks, vegetation, obstruction to flow, variations in cross sections and surface irregularity.
  - (f) Detailed hydrologic and hydraulic calculations to obtain the 100-year water surface elevations (WSE). The acceptable methodologies and models are specified within this Guidebook in Appendix H;
  - (g) Delineation of the 100-year WSE on the project drainage plan to show the location and approximate extent of the overland relief path and areas that may be affected by the surface storage for the 100-year storm event. Overlaying arrows, shading or other suitable see-through graphics are suggested for this purpose.
  - (h) Certification by the DC PE that no buildings will be subject to increased flooding by the 100-year post-development discharge from the development site.
3. If buildings will be flooded based on the analysis, then the design engineer must perform more precise hydrologic and hydraulic computations. In addition to the on-site 100-year detention, the applicant shall design the outfall drainage system, overland relief swales, and/or surface storage in such a way that no building will be damaged by flooding.
4. If the protection measures for the outfall drainage system or overland relief path are provided, necessary design details shall be shown and supported by calculations and submitted to DDOE for review.

### **Hydrologic and Hydraulic (H&H) Analysis:**

1. Consult DDOE to initially determine whether or not the H&H analysis is needed. This analysis is used to determine the impact on SFHA by considering the entire watershed.
2. The acceptable methodologies and models for H&H analysis are specified in Section 2.7 and further described in Appendix H.
3. Hydrologic and Hydraulic (H&H) investigations may be required to demonstrate that downstream roads, bridges and public utilities are adequately protected from the Q<sub>f</sub> storm. These investigations typically extend to the first downstream tributary of equal or greater drainage area or to any downstream dam, highway, or natural point of restricted stream flow.

## **2.6 Additional Stormwater Management Requirements**

Any BMP which may receive stormwater runoff from areas which may be potential sources of oil and grease contamination in concentration exceeding 10 milligrams per liter (mg/L) shall include a baffle, skimmer, oil separator, grease trap, or other mechanism which prevents oil and grease from escaping the stormwater discharge facility in concentrations exceeding 10 milligrams per liter (mg/L).

Any BMP which receives stormwater runoff from areas used to confine animals may be required to be connected to a sanitary or combined sewer and to meet pretreatment requirements of the District of Columbia Water and Sewer Authority.

## **2.7 Hydrology Methods**

The following are the acceptable methodologies and computer models for estimating runoff hydrographs before and after development. These methods are used to predict the runoff response from given rainfall information and site surface characteristic conditions. The design storm frequencies used in all of the hydrologic engineering calculations will be based on design storms required in this guidebook unless circumstances make consideration of another storm intensity criteria appropriate.

- Urban Hydrology for Small Watersheds TR-55 (TR-55)
- Storage-Indication Routing
- HEC-HMS, WinTR-55, TR-20, and SWMM Computer Models
- Rational Method (limited to sites under 5 acres)

These methods are given as valid in principle, and are applicable to most stormwater management design situations in the District. Other methods may be used when the District reviewing authority approves their application.

The use of the Natural Resource Conservation Service storage indication routing method or an equivalent acceptable method may be required to route the design storms through stormwater facilities. A modified version of the NRCS Curve Number Method is provided for computing the peak discharge for the SWRv 1.2-inch rain event. See Appendix H for further details and guidance on both computation procedures.

## 2.8 Acceptable Urban BMP Options

This section sets forth thirteen acceptable groups of BMPs that can be used to meet the Stormwater Retention Volume (SWRv), and/or peak flow (Qp2, Qp15, Qf) criteria.

The dozens of different BMP designs currently used in the District are assigned into thirteen general categories for stormwater quality control:

- BMP Group 1 Green Roofs
- BMP Group 2 Rainwater Harvesting
- BMP Group 3 Impervious Surface Disconnection
- BMP Group 4 Permeable Pavement Systems
- BMP Group 5 Bioretention
- BMP Group 6 Filtering Systems
- BMP Group 7 Infiltration
- BMP Group 8 Open Channel Systems
- BMP Group 9 Ponds
- BMP Group 10 Wetlands
- BMP Group 11 Storage Practices
- BMP Group 12 Proprietary Practices
- BMP Group 13 Tree Planting and Preservation

Within each BMP group, detailed performance criteria are presented that govern feasibility, conveyance, pretreatment, treatment, landscaping, construction sequence, maintenance, and stormwater retention calculations (see Chapter 3).

Guidance on selecting the most appropriate combination of BMPs is provided in Chapter 4.

### **BMP Group 1 Green Roofs**

Green roofs are BMPs that capture and store rainfall that would otherwise land on an impervious rooftop in an engineered growing media that is designed to support plant growth. A portion of the captured rainfall evaporates or is taken up by plants, which helps reduce runoff volumes, peak runoff rates, and pollutant loads. Design variants include:

- G-1 Extensive green roofs have a much shallower growing media layer that typically ranges from 3 to 6 inches thick.
- G-2 Intensive green roofs have a growing media layer that ranges from 6 inches to 4 feet thick.

## **BMP Group 2 Rainwater Harvesting**

Rain water harvesting systems intercept, divert, store and release rainfall for future use. Rainwater that falls on a rooftop is collected and conveyed into an above- or below-ground storage tank (also referred to as a cistern or rain tank), where it can be used for non-potable water uses and on-site stormwater disposal/infiltration.

## **BMP Group 3 Impervious Surface Disconnection**

This strategy involves managing runoff close to its source by intercepting, infiltrating, filtering, treating or reusing it as it moves from the impervious surface to the drainage system. Simple disconnection variants include:

- D-1 Simple disconnection to a pervious compacted cover area
- D-2 Simple disconnection to a conserved natural cover area
- D-3 Simple disconnection to a soil compost amended filter path

Disconnection can also be employed as part of infiltration, bioretention, and rainwater harvesting systems.

## **BMP Group 4 Permeable Pavement Systems**

Permeable pavement is an alternative paving surface that captures and temporarily stores the design volume by filtering runoff through voids in the pavement surface into an underlying stone reservoir. Filtered runoff may be collected and returned to the conveyance system, or allowed to partially infiltrate into the soil. Design variants include:

- P-1 Porous asphalt (PA)
- P-2 Pervious concrete (PC)
- P-3 Permeable pavers (PP)

## **BMP Group 5 Bioretention**

Bioretention facilities are BMPs that capture and store stormwater runoff and pass it through a filter bed of engineered soil media comprised of sand, soil and organic matter. Filtered runoff may be collected and returned to the conveyance system, or allowed to infiltrate into the soil. Design variants include:

- B-1 Traditional bioretention
- B-2 Streetscape bioretention
- B-3 Engineered tree pits
- B-4 Stormwater planters
- B-5 Residential rain gardens

### **BMP Group 6 Filtering Systems**

Filtering systems are BMPs that capture and temporarily store the design volume and pass it through a filter bed of sand, organic matter, soil or other filtering media. Filtered runoff may be collected and returned to the conveyance system. Design variants include:

- F-1 Non-structural sand filter
- F-2 Surface sand filter
- F-3 Three-chamber underground sand filter
- F-4 Perimeter sand filter

### **BMP Group 7 Infiltration BMPs**

Infiltration BMPs capture and store the design volume before allowing it to infiltrate into the soil over a two day period. Design variants include:

- I-1 Infiltration trench
- I-2 Infiltration basin

### **BMP Group 8 Open Channel BMPs**

Open channel BMPs are vegetated open channels that are designed to capture and treat or convey the design storm volume. Design variants include:

- O-1 Grass channels
- O-2 Dry swale
- O-3 Wet swale

### **BMP Group 9 Ponds**

Stormwater ponds are stormwater storage BMPs that consist of a combination of a permanent pool, micropool, or shallow marsh that promote a good environment for gravitational settling, biological uptake and microbial activity. Design variants include:

- P-1 Micropool extended detention pond
- P-2 Wet pond
- P-3 Wet extended detention (ED) pond

### **BMP Group 10 Wetlands**

Stormwater wetlands are BMPs that create shallow marsh areas to treat urban stormwater which often incorporate small permanent pools and/or extended detention storage. Stormwater wetlands are explicitly designed to provide stormwater detention for larger storms (2-year, 15-year or flood control events) above the Retention Storage Volume (SWR<sub>v</sub>). Design variants include:

W-1 Shallow wetland

W-2 Extended detention (ED) shallow wetland

### **BMP Group 11 Storage Practices**

Storage practices are explicitly designed to provide stormwater detention (2-year, 15-year, and/or flood control). Storage practices, alone, are not considered acceptable practices to meet Retention Storage Volume (SWR<sub>v</sub>), or TSS removal, requirements. Design variants include:

S-1 Underground vault

S-2 Dry pond

S-3 Rooftop storage

S-4 Stone storage under permeable pavement or other BMPs

Design guidance and criteria for the practice of rooftop storage is provided in Appendix I.

### **BMP Group 12 Proprietary Practices**

Proprietary practices are manufactured stormwater BMPs that utilize settling, filtration, absorptive/adsorptive materials, vortex separation, vegetative components, and/or other appropriate technology to manage the impacts of stormwater runoff.

Proprietary practices may establish Retention Volume (SWR<sub>v</sub>) value, as well as TSS removal value, provided they have been approved by the District through the approval process detailed in Appendix T.

### **BMP Group 13 Tree Planting and Preservation**

Trees can significantly reduce stormwater runoff by canopy interception and uptake of water from the soil. Trees are well documented in their ability to reduce stormwater runoff, particularly when the tree canopy covers impervious surface, such as in the case of street trees.

# Chapter 3                      Stormwater Best Management Practices (BMPs)

## 3.1    Standard Best Management Practice Design Guidance Format

This chapter outlines performance criteria for 13 stormwater Best Management Practice (BMP) categories that include green roofs, rainwater harvesting, impermeable surface disconnection, permeable pavement, bioretention, filtering systems, infiltration practices, storage practices, ponds, wetlands, open channels, proprietary practices, and tree planting.

BMP performance criteria are based on several critical design factors to ensure effective and long-lived BMPs. Design components that differ from these specifications but meet their intent may be included at the District Department of the Environment (DDOE) discretion. In this chapter, and throughout the Guidebook, the terms “~~must~~,” or “~~shall~~” denote required aspects of BMPs or their design and implementation, while the term “~~should~~” denotes a recommendation. However, justification may be necessary for design or implementation that does not correspond to certain recommendations.

For each BMP, the following factors are discussed:

- General Feasibility
- Conveyance
- Pretreatment
- Design and Sizing
- Landscaping
- Construction Sequencing
- Maintenance
- Stormwater Compliance Calculations

## 3.2 Green Roofs

**Definition.** Practices that capture and store rainfall in an engineered growing media that is designed to support plant growth. A portion of the captured rainfall evaporates or is taken up by plants, which helps reduce runoff volumes, peak runoff rates, and pollutant loads on development sites. Green roofs typically contain a layered system of roofing, which is designed to support plant growth and retain water for plant uptake while preventing ponding on the roof surface. The roofs are designed so that water drains vertically through the media and then horizontally along a waterproofing layer towards the outlet. Extensive green roofs are designed to have minimal maintenance requirements. Plant species are selected so that the roof does not need supplemental irrigation and requires minimal, infrequent fertilization after vegetation is initially established.

Design variants include:

- G-1 Extensive green roofs have a much shallower growing media layer that typically ranges from 3 to 6 inches thick.
- G-2 Intensive green roofs have a growing media layer that ranges from 6 to 48 inches thick.

Green roofs are typically not designed to provide stormwater detention of larger storms (e.g., 2-year, 15-year) although some intensive green roof systems may be designed to meet these criteria. Most green roof designs shall generally be combined with a separate facility to provide large storm controls.

This specification is intended for situations where the primary design objective of the green roof is stormwater management and, unless specified otherwise, addresses the design of extensive roof systems. While rooftop practices such as urban agriculture may provide some retention, their primary design objective is not stormwater management and is not addressed in this specification.

### 3.2.1 Green Roof Feasibility Criteria

Green roofs are ideal for use on commercial, institutional, municipal, and multi-family residential buildings. They are particularly well-suited for use on ultra-urban development and redevelopment sites. Key constraints with green roofs include the following:

**Structural Capacity of the Roof.** When designing a green roof, designers must not only consider the stormwater storage capacity of the green roof but also its structural capacity to support the weight of the additional water. A conventional rooftop should typically be designed to support an additional 15 to 30 pounds per square foot (psf) for an extensive green roof. As a result, a structural engineer, architect, or other qualified professional should be involved with all green roof designs to ensure that the building has enough structural capacity to support a green roof. See Section 3.2.4 Green Roof Design Criteria for more information on structural design considerations.

**Roof Pitch.** Green roof storage volume is maximized on relatively flat roofs (a pitch of 1 to 2 percent). Some pitch is needed to promote positive drainage and prevent ponding and/or



saturation of the growing media. Green roofs can be installed on rooftops with slopes up to 30 percent if baffles, grids, or strips are used to prevent slippage of the media. These baffles must be designed to ensure the roof provides adequate storage for the design storm. Slopes greater than 30 percent would be considered a green wall, which is not specifically identified as a stormwater Best Management Practice (BMP). Green walls can be used to receive cistern discharge (calculations are necessary to determine demand) and can be used to comply with Green Area Ratio Requirements (see Appendix J).

**Roof Access.** Adequate access to the roof must be available to deliver construction materials and perform routine maintenance. Roof access can be achieved either by an interior stairway through a penthouse or by an alternating tread device with a roof hatch or trap door not less than 16 square feet in area and with a minimum dimension of 24 inches (NVRC, 2007). Designers should also consider how they will get construction materials up to the roof (e.g., by elevator or crane) and how the roof structure can accommodate material stockpiles and equipment loads. If material and equipment storage is required, rooftop storage areas must be identified and clearly marked based on structural load capacity of the roof.

**Roof Type.** Green roofs can be applied to most roof surfaces. Certain roof materials, such as exposed treated wood and uncoated galvanized metal, may not be appropriate for green rooftops due to pollutant leaching through the media (Clark et al, 2008).

**Setbacks.** Green roofs should not be located near rooftop electrical and HVAC systems. A 2-foot wide vegetation-free zone is recommended along the perimeter of the roof with a 1-foot vegetation-free zone around all roof penetrations, to act as a firebreak. The 2-foot setback may be relaxed for small or low green roof applications where parapets have been properly designed.

**Contributing Drainage Area.** It is recommended that the entire contributing drainage area to a green roof (including the green roof itself) be no more than 25 percent larger than the area of the green roof. In cases where the area exceeds this threshold, the designer must provide supporting documentation of rooftop loading, sufficient design to distribute runoff throughout the green roof and prevent erosion of the roof surface, and justification for incorporating a sizable external drainage area to the green roof.

**District Building Codes.** The green roof design must comply with the District Building Codes with respect to roof drains and emergency overflow devices. Additionally, a District of Columbia registered structural engineer must certify that the design complies with District Building structural codes. This is true for new construction as well as retrofit projects.

### 3.2.2 Green Roof Conveyance Criteria

The green roof drainage layer (refer to Section 3.2.4) must convey flow from under the growing media directly to an outlet or overflow system such as a traditional rooftop downspout drainage system. The green roof drainage layer must be adequate to convey the volume of stormwater equal to the flow capacity of the overflow or downspout system without backing water up onto the rooftop or into the green roof media. Roof drains immediately adjacent to the growing media should be boxed and protected by flashing extending at least 3 inches above the growing media to prevent clogging. However, an adequate number of roof drains that are not immediately

adjacent to the growing media must be provided so as to allow the roof to drain without 3 inches of ponding above the growing media.

### 3.2.3 Green Roof Pretreatment Criteria

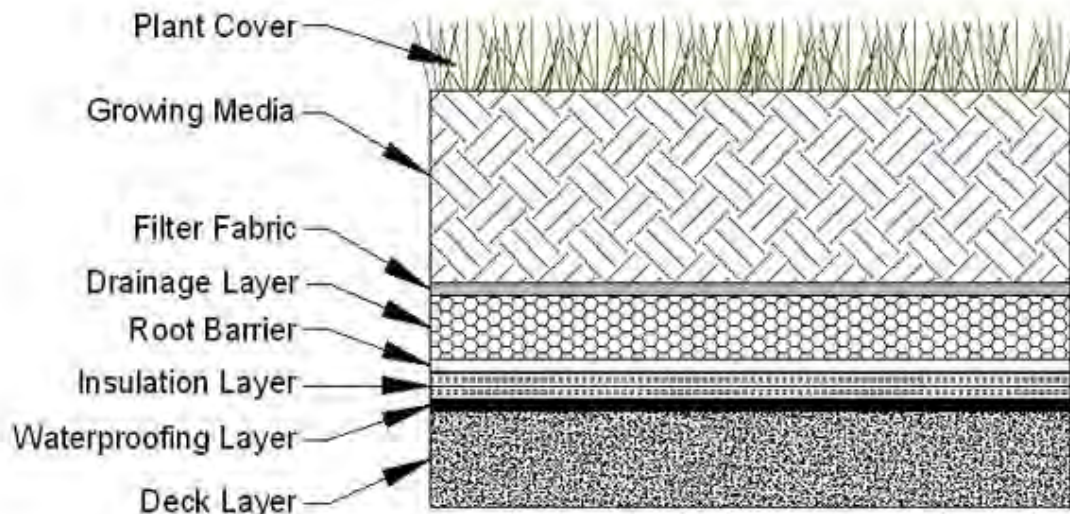
Pretreatment is not necessary for green roofs.

### 3.2.4 Green Roof Design Criteria

**Structural Capacity of the Roof.** Green roofs can be limited by the additional weight of the fully saturated soil and plants, in terms of the physical capacity of the roof to bear structural loads. The designer shall consult with a licensed structural engineer to ensure that the building will be able to support the additional live and dead structural load and to determine the maximum depth of the green roof system and any needed structural reinforcement. Typically, the green roof manufacturer can provide specific background specifications and information on their product for planning and design.

In most cases, fully saturated extensive green roofs have loads of about 15 to 30 pounds per square foot, which is fairly similar to traditional new rooftops (12 to 15 pounds per square foot) that have a waterproofing layer anchored with stone ballast. For a discussion of green roof structural design issues, consult Chapter 9 in Weiler and Scholz-Barth (2009) and ASTM E-2397, Standard Practice for Determination of Dead Loads and Live Loads Associated with Green (Green) Roof Systems.

**Functional Elements of a Green Roof System.** A green roof is composed of up to 9 different systems or layers, from bottom to top, that are combined together to protect the roof and maintain a vigorous cover (see Figure 3.1).



**Figure 3.1** Typical layers for a green roof. (Note: the relative placement of various layers may vary depending on the type and design of the green roof system).

The design layers include the following:

1. **Deck Layer.** The roof deck layer is the foundation of a green roof. It may be composed of concrete, wood, metal, plastic, gypsum, or a composite material. The type of deck material determines the strength, load bearing capacity, longevity, and potential need for insulation in the green roof system.
2. **Leak Detection System (optional).** Leak detection systems are often installed above the deck layer to identify leaks, minimize leak damage through timely detection, and locate leak locations.
3. **Waterproofing Layer.** All green roof systems must include an effective and reliable waterproofing layer to prevent water damage through the deck layer. A wide range of waterproofing materials can be used, including hot applied rubberized asphalt, built up bitumen, modified bitumen, thermoplastic membranes, polyvinyl chloride (PVC), thermoplastic olefin membrane (TPO), and elastomeric membranes (EPDM) (see Weiler and Scholz-Barth, 2009 and Snodgrass and Snodgrass, 2006). The waterproofing layer must be 100 percent waterproof and have an expected life span as long as any other element of the green roof system. The waterproofing material may be loose laid or bonded (recommended). If loose laid, overlapping and additional construction techniques should be used to avoid water migration.
4. **Insulation Layer.** Many green rooftops contain an insulation layer, usually located above, but sometimes below, the waterproofing layer. The insulation increases the energy efficiency of the building and/or protects the roof deck (particularly for metal roofs). According to Snodgrass and Snodgrass (2006), the trend is to install insulation on the outside of the building, in part to avoid mildew problems. The designer should consider the use of open or closed cell insulation depending on whether the insulation layer is above or below the waterproofing layer (and thus exposed to wetness), with closed cell insulation recommended for use above the waterproofing layer.
5. **Root Barrier.** Another layer of a green roof system, which can be either above or below the insulation layer depending on the system, is a root barrier that protects the waterproofing membrane from root penetration. A wide range of root barrier options are described in Weiler and Scholz-Barth (2009). Chemical root barriers or physical root barriers which have been impregnated with pesticides, metals, or other chemicals that could leach into stormwater runoff, must be avoided in systems where the root barrier layer will come in contact with water or allow water to pass through the barrier.
6. **Drainage Layer and Drainage System.** A drainage layer is then placed between the root barrier and the growing media to quickly remove excess water from the vegetation root zone. The selection and thickness of the drainage layer type is an important design decision that is governed by the desired stormwater storage capacity, the required conveyance capacity, and the structural capacity of the rooftop. The effective depth of the drainage layer is generally 0.25 to 1.5 inches thick for extensive green roof system and increases for intensive designs. The drainage layer should consist of synthetic or inorganic materials (e.g., 1-2 inch layer of clean, washed granular material (ASTM D448 size No. 8 stone or lightweight granular mix), high density polyethylene (HDPE)) that are capable of retaining water and providing efficient drainage. A wide range of prefabricated water cups or plastic modules can be used, as well as

a traditional system of protected roof drains, conductors, and roof leaders. ASTM E2396 and E2398 can be used to evaluate alternative material specifications.

7. **Root-Permeable Filter Fabric.** A semi-permeable needled polypropylene filter fabric is normally placed between the drainage layer and the growing media to prevent the media from migrating into the drainage layer and clogging it. The filter fabric must not impede the downward migration of water into the drainage layer.
8. **Growing Media.** The next layer in an extensive green roof is the growing media, which is typically 3 to 6 inches deep (minimum 3 inches). The recommended growing media for extensive green roofs is typically composed of approximately 70 to 80 percent lightweight inorganic materials, such as expanded slates, shales or clays, pumice, scoria, or other similar materials. The remaining media must contain no more than 30 percent organic matter, normally well-aged compost (see Appendix K). The percentage of organic matter should be limited, since it can leach nutrients into the runoff from the roof and clog the permeable filter fabric. The growing media **typically has** a maximum water retention of approximately 30 percent. Proof of growing media maximum water retention must be provided by the manufacturer. It is advisable to mix the media in a batch facility prior to delivery to the roof. As there are many different types of proprietary growing medias and roof systems, the values provided here are recommendations only. Manufacturer's specifications should be followed for all proprietary roof systems. More information on growing media can be found in Weiler and Scholz-Barth (2009) and Snodgrass and Snodgrass (2006).

The composition of growing media for intensive green roofs may be different, and it is often much greater in depth (e.g., 6 to 48 inches). If trees are included in the green roof planting plan, the growing media must be sufficient to provide enough soil volume for the root structure of mature trees.

9. **Plant Cover.** The top layer of an extensive green roof typically consists of plants that are non-native, slow-growing, shallow-rooted, perennial, and succulent. These plants are chosen because their ability to withstand harsh conditions at the roof surface. Guidance on selecting the appropriate green roof plants can often be provided by green roof manufacturers and can also be found in Snodgrass and Snodgrass (2006). A mix of base ground covers (usually Sedum species) and accent plants can be used to enhance the visual amenity value of a green roof. See Section 3.2.4 Green Roof Design Criteria for additional plant information. The design must provide for temporary, manual, and/or permanent irrigation or watering systems, depending on the green roof system and types of plants. For most application, some type of watering system should be accessible for initial establishment or drought periods. The use of water efficient designs and/or use of non-potable sources are strongly encouraged.

**Material Specifications.** Standards specifications for North American green roofs continue to evolve, and no universal material specifications exist that cover the wide range of roof types and system components currently available. The ASTM has recently issued several overarching green roof standards, which are described and referenced in Table 3.1 below.

Designers and reviewers should also fully understand manufacturer specifications for each system component, particularly if they choose to install proprietary “complete” green roof systems or modules.

**Table 3.1 Extensive Green Roof Material Specifications**

Material	Specification
Roof	Structural capacity must conform to ASTM E-2397-05, <i>Practice for Determination of Live Loads and Dead Loads Associated with Green (Green) Roof Systems</i> . In addition, use standard test methods ASTM E2398-05 for <i>Water Capture and Media Retention of Geocomposite Drain Layers for Green (Vegetated) Roof Systems</i> , and ASTM E 2399-05 for <i>Maximum Media Density for Dead Load Analysis</i> .
Leak Detection System	Optional system to detect and locate leaks in the waterproof membrane.
Waterproof Membrane	See Chapter 6 of Weiler and Scholz-Barth (2009) for waterproofing options that are designed to convey water horizontally across the roof surface to drains or gutter. This layer may sometimes act as a root barrier.
Root Barrier	Impermeable liner that impedes root penetration of the membrane.
Drainage Layer	Depth of the drainage layer is generally 0.25 to 1.5 inches thick for extensive designs. The drainage layer should consist of synthetic or inorganic materials (e.g., gravel, high density polyethylene (HDPE), etc.) that are capable of retaining water and providing efficient drainage. A wide range of prefabricated water cups or plastic modules can be used, as well as a traditional system of protected roof drains, conductors, and roof leaders. Designers should consult the material specifications as outlined in ASTM E2396 and E2398. Roof drains and emergency overflow must be designed in accordance with District Construction Code (DCMR, Title 12).
Filter Fabric	Generally, needle-punched, non-woven, polypropylene geotextile, with the following qualities: <ul style="list-style-type: none"> <li>• Strong enough and adequate puncture resistance to withstand stresses of installing other layers of the green roof. Density as per ASTM D3776 <math>\geq 8</math> oz./yd<sup>2</sup>. Puncture Resistance as per ASTM D4833 <math>\geq 130</math> lb These values can be reduced with submission of a Product Data Sheet and other documentation that demonstrates applicability for the intended use.</li> <li>• Adequate tensile strength and tear resistance for long term performance.</li> <li>• Allows a good flow of water to the drainage layer. Apparent Opening Size as per ASTM D4751 <math>\geq 0.06 \leq 0.2</math>, with other values based on Product Data Sheet and other documentation as noted above.</li> <li>• Allows at least fine roots to penetrate.</li> </ul> Adequate resistance to soil borne chemicals or microbial growth both during construction and after completion since the fabric will be in contact with moisture and possibly fertilizer compounds.
Growth Media	70% to 80% lightweight inorganic materials and a maximum of 30% organic matter (e.g., well-aged compost). Media typically has a maximum water retention of approximately 30%. Material makeup and proof of maximum water retention of the growing media must be provided. Media must provide sufficient nutrients and water holding capacity to support the proposed plant materials. Determine acceptable saturated water permeability using ASTM E2396-05.
Plant Materials	Sedum, herbaceous plants, and perennial grasses that are shallow-rooted, low maintenance, and tolerant of direct sunlight, drought, wind, and frost. See ASTM E2400-06, <i>Guide for Selection, Installation and Maintenance of Plants for Green (Vegetated) Roof Systems</i> .

**Green Roof Sizing.** Green roof areas can be designed to capture the entire stormwater retention volume (SWR<sub>v</sub>). In some cases, they could be designed to capture larger design storm volumes as well. The required size of a green roof will depend on several factors, including maximum water retention of the growing media and the underlying drainage and storage layer materials (e.g., prefabricated water cups or plastic modules). As maximum water retention can vary significantly between green roof products, verification of this value must be included with the Stormwater Management Plan (SWMP). ASTM tests E2396, E2397, E2398, or E2399, as appropriate, and performed by an ASTM-certified lab are considered acceptable verification. In the absence of ASTM test results, a maximum water retention of 0.25 must be used. Site designers and planners should consult with green roof manufacturers and material suppliers as they can often provide specific sizing information and hydrology design tools for their products. Equation 3.1 below shall be used to determine the storage volume retained by a green roof.

**Equation 3.1 Storage Volume for Green Roofs**

$$S_v = \frac{SA \times [(d \times \eta_1) + (DL \times \eta_2)]}{12}$$

where:

- $S_v$  = storage volume (ft<sup>3</sup>)
- $SA$  = green roof area (ft<sup>2</sup>)
- $d$  = media depth (in.) (minimum 3 in.)
- $\eta_1$  = verified media maximum water retention (use 0.15 as a baseline default in the absence of verification data)
- $DL$  = drainage layer depth (in.)
- $\eta_2$  = verified drainage layer maximum water retention (use 0.15 as a baseline default in the absence of verification data)

The appropriate  $S_v$  can then be compared to the required SWR<sub>v</sub> for the entire rooftop area (including all non-green areas) to determine the portion of the design storm captured.

Green roofs can have dramatic rate attenuation effects on larger storm events and may be used, in part, to manage a portion of the 2-year and 15-year events. Designers can model various approaches by factoring in storage within the drainage layer. Routing calculations can also be used to provide a more accurate solution of the peak discharge and required storage volume.

### 3.2.5 Green Roof Landscaping Criteria

Plant selection, landscaping, and maintenance are critical to the performance and function of green roofs. Therefore, a landscaping plan shall be provided for green roofs.

A planting plan must be prepared for a green roof by a landscape architect, botanist, or other professional experienced with green roofs and submitted with the Stormwater Management Plan (SWMP).

Plant selection for green rooftops is an integral design consideration, which is governed by local climate and design objectives. The primary ground cover for most green roof installations is a hardy, low-growing succulent, such as *Sedum*, *Delosperma*, *Talinum*, *Semperivum*, or *Hieracium* that is matched to the local climate conditions and can tolerate the difficult growing conditions found on building rooftops (Snodgrass and Snodgrass, 2006).

A list of some common green roof plant species that work well in the Chesapeake Bay watershed can be found in Table 3.2 below.

- Plant choices can be much more diverse for deeper intensive green roof systems. Herbs, forbs, grasses, shrubs, and even trees can be used, but designers should understand they may have higher watering, weeding, and landscape maintenance requirements.
- The species and layout of the planting plan must reflect the location of the building, in terms of its height, exposure to wind, snow loading, heat stress, orientation to the sun, and impacts from surrounding buildings. (Wind scour and solar burning have been observed on green roof installations that failed to adequately account for neighboring building heights and surrounding window reflectivity.) In addition, plants must be selected that are fire resistant and able to withstand heat, cold, and high winds.

**Table 3.2 Ground Covers Appropriate for Green Roofs in the District of Columbia**

Plant	Light	Moisture Requirement	Notes
<i>Delosperma cooperii</i>	Full Sun	Dry	Pink flowers; grows rapidly
<i>Delosperma 'Kelaidis'</i>	Full Sun	Dry	Salmon flowers; grows rapidly
<i>Delosperma nubigenum 'Basutoland'</i>	Full Sun	Moist-Dry	Yellow flowers; very hardy
<i>Sedum album</i>	Full Sun	Dry	White flowers; hardy
<i>Sedum lanceolatum</i>	Full Sun	Dry	Yellow flowers; native to U.S.
<i>Sedum oregonum</i>	Part Shade	Moist	Yellow flowers; native to U.S.
<i>Sedum stoloniferum</i>	Sun	Moist	Pink flowers; drought tolerant
<i>Sedum telephiodes</i>	Sun	Dry	Blue green foliage; native to region
<i>Sedum ternatum</i>	Part Shade	Dry-Moist	White flowers; grows in shade
<i>Talinum calycinum</i>	Sun	Dry	Pink flowers; self sows

Note: Designers should choose species based on shade tolerance, ability to sow or not, foliage height, and spreading rate. See Snodgrass and Snodgrass (2006) for a definitive list of green roof plants, including accent plants.

- Designers should also match species to the expected rooting depth of the growing media, which can also provide enough lateral growth to stabilize the growing media surface. The

planting plan should usually include several accent plants to provide diversity and seasonal color. For a comprehensive resource on green roof plant selection, consult Snodgrass and Snodgrass (2006).

- It is also important to note that most green roof plant species will not be native to the Chesapeake Bay watershed (which contrasts with native plant recommendations for other stormwater practices, such as bioretention and constructed wetlands).
- Given the limited number of green roof plant nurseries in the region, it may be necessary for designers to order plants 6 to 12 months prior to the expected planting date. It is also advisable to have plant materials contract grown.
- When appropriate species are selected, most green roofs will not require supplemental irrigation, except for temporary irrigation during drought or initial establishment. The design must provide for temporary, manual, and/or permanent irrigation or watering systems, and the use of water efficient designs and/or use of non-potable sources is strongly encouraged. The planting window extends from the spring to early fall; although, it is important to allow plants to root thoroughly before the first killing frost. Green roof manufacturers and plant suppliers may provide guidance on planting windows as well as winter care. Proper planting and care may also be required for plant warranty eligibility.
- Plants can be established using cuttings, plugs, mats, and, more rarely, seeding or containers. Several vendors also sell mats, rolls, or proprietary green roof planting modules. For the pros and cons of each method, see Snodgrass and Snodgrass (2006).
- The goal for green roof systems designed for stormwater management is to establish a full and vigorous cover of low-maintenance vegetation that is self-sustaining (not requiring fertilizer inputs) and requires minimal mowing, trimming, and weeding.

The green roof design should include non-vegetated walkways (e.g., paver blocks, see Section 3.2.4 Green Roof Design Criteria) to allow for easy access to the roof for weeding and making spot repairs.

### **3.2.6 Green Roof Construction Sequence**

**Green Roof Installation.** Given the diversity of extensive vegetated roof designs, there is no typical step-by-step construction sequence for proper installation. The following general construction considerations are noted:

- Construct the roof deck with the appropriate slope and material.
- Install the waterproofing method, according to manufacturer's specifications.
- Conduct a flood test to ensure the system is watertight by placing at least 2 inches of water over the membrane for 48 hours to confirm the integrity of the waterproofing system. Alternately, electric field vector mapping (EFVM) can be done to test for the presence of leaks; however, not all impermeable membranes are testable with this method. Problems have been noted with the use of EFVM on black EPDM membranes and with aluminized protective coatings commonly used in conjunction with modified bituminous membranes.
- Add additional system components (e.g., insulation, root barrier, drainage layer and interior drainage system, and filter fabric), per manufacturers specifications, taking care not to



damage the waterproofing. Any damage occurring must be reported immediately. Drain collars and protective flashing should be installed to ensure free flow of excess stormwater.

- The growing media should be mixed prior to delivery to the site. Media must be spread evenly over the filter fabric surface as required by the manufacturer. If a delay between the installation of the growing media and the plants is required, adequate efforts must be taken to secure the growing media from erosion and the seeding of weeds. The growing media must be covered and anchored in place until planting. Sheets of exterior grade plywood can also be laid over the growing media to accommodate foot or wheelbarrow traffic. Foot traffic and equipment traffic should be limited over the growing media to reduce compaction beyond manufacturer's recommendations.
- The growing media should be moistened prior to planting, and then planted with the ground cover and other plant materials, per the planting plan or in accordance with ASTM E2400. Plants should be watered immediately after installation and routinely during establishment.
- It generally takes 2 to 3 growing seasons to fully establish the vegetated roof. The growing medium should contain enough organic matter to support plants for the first growing season, so initial fertilization is not required. Extensive green roofs may require supplemental irrigation during the first few months of establishment. Hand weeding is also critical in the first two years (see Table 10.1 of Weiler and Scholz-Barth, 2009, for a photo guide of common rooftop weeds).
- Most construction contracts should contain a Care and Replacement Warranty that specifies at least 50 percent coverage after one year and 80 percent coverage after two years for plugs and cuttings, and 90 percent coverage after one year for sedum carpet/tile.

**Construction Supervision.** Supervision during construction is recommended to ensure that the vegetated roof is built in accordance with these specifications. Inspection checklists should be used that include sign-offs by qualified individuals at critical stages of construction and confirm that the contractor's interpretation of the plan is consistent with the intent of the designer and/or manufacturer.

An experienced installer should be retained to construct the vegetated roof system. The vegetated roof should be constructed in sections for easier inspection and maintenance access to the membrane and roof drains. Careful construction supervision/inspection is needed during several steps of vegetated roof installation, as follows:

- During placement of the waterproofing layer, to ensure that it is properly installed and watertight.
- During placement of the drainage layer and drainage system.
- During placement of the growing media, to confirm that it meets the specifications and is applied to the correct depth (certification for vendor or source should be provided).
- Upon installation of plants, to ensure they conform to the planting plan (certification from vendor or source should be provided).
- Before issuing use and occupancy approvals.

- At the end of the first or second growing season to ensure desired surface cover specified in the Care and Replacement Warranty has been achieved.

DDOE’s construction phase inspection checklist for green roof practices can be found in Appendix L.

### 3.2.7 Green Roof Maintenance Criteria

**Maintenance Inspections.** A green roof should be inspected by a qualified professional twice a year during the growing season to assess vegetative cover and to look for leaks, drainage problems, and any rooftop structural concerns (see Table 3.3). In addition, the green roof should be hand weeded to remove invasive or volunteer plants, and plants and/or media should be added to repair bare areas (refer to ASTM E2400 (ASTM, 2006)).

If a roof leak is suspected, it is advisable to perform an electric leak survey (e.g., Electric Field Vector Mapping), if applicable, to pinpoint the exact location, make localized repairs, and then reestablish system components and ground cover.

The use of herbicides, insecticides, and fungicides should be avoided, since their presence could hasten degradation of some waterproofing membranes. Check with the membrane manufacturer for approval and warranty information. Also, power washing and other exterior maintenance operations should be avoided so that cleaning agents and other chemicals do not harm the green roof plant communities.

Fertilization is generally not recommended due to the potential for leaching of nutrients from the green roof. Supplemental fertilization may be required following the first growing season, but only if plants show signs of nutrient deficiencies and a media test indicates a specific deficiency. Addressing this issue with the holder of the vegetation warranty is recommended. If fertilizer is to be applied, it must be a slow-release type, rather than liquid or gaseous form (Green Roof).

DDOE’s maintenance inspection checklist for green roofs can be found in Appendix M.

**Table 3.3 Typical Maintenance Activities Associated with Green Roofs**

Schedule (following construction)	Activity
As needed or As required by manufacturer	<ul style="list-style-type: none"> <li>▪ Water to promote plant growth and survival.</li> <li>▪ Inspect the green roof and replace any dead or dying vegetation.</li> </ul>

Schedule (following construction)	Activity
Semi-annually	<ul style="list-style-type: none"> <li>▪ Inspect the waterproof membrane for leaks and cracks.</li> <li>▪ Weed to remove invasive plants (do not dig or use pointed tools where there is potential to harm the root barrier or waterproof membrane).</li> <li>▪ Inspect roof drains, scuppers, and gutters to ensure they are not overgrown and have not accumulated organic matter deposits. Remove any accumulated organic matter or debris.</li> <li>▪ Inspect the green roof for dead, dying, or invasive vegetation. Plant replacement vegetation as needed.</li> </ul>

**Declaration of Covenants.** A declaration of covenants that includes all maintenance responsibilities to ensure the continued stormwater performance for the BMP is required. The declaration of covenants specifies the property owner’s primary maintenance responsibilities, and authorizes DDOE staff to access the property for inspection or corrective action in the event the proper maintenance is not performed. The declaration of covenants is attached to the deed of the property. An example form is provided at the end of Chapter 5 though variations will exist for scenarios where stormwater crosses property lines. The covenant is between the property and the District Government. It is submitted through the Office of the Attorney General (OAG). All SWMPs have a maintenance agreement stamp that must be signed for a building permit to proceed. A maintenance schedule must appear on the SWMP. Additionally, a maintenance schedule is required in schedule c of the declaration of covenants.

Covenants are not required on government properties, but maintenance responsibilities must be defined through a partnership agreement or a memorandum of understanding.

**Waste Materials.** Waste material from the repair, maintenance, or removal of a BMP or land cover shall be removed and disposed of in compliance with applicable federal and District law.

### 3.2.8 Green Roof Stormwater Compliance Calculations

Green roofs receive 100 percent retention value for the amount of storage volume (Sv) provided by the practice (see Table 3.4). Since the practice gets 100 percent retention value, it is not considered an accepted TSS treatment practice.

**Table 3.4 Green Roof Design Performance**

Retention Value	= Sv
Accepted TSS Treatment Practice	N/A

The practice must be designed using the guidance detailed in Section 3.2.4.

Green roofs also contribute to peak flow reduction. This contribution can be determined in several ways. One method is to subtract the  $S_v$  from the total runoff volume for the 2-year, 15-year, and 100-year storms. The resulting reduced runoff volumes can then be used to calculate a Reduced Natural Resource Conservation Service (NRCS) Curve Number for the site or drainage area. The Reduced Curve Number can then be used to calculate peak flow rates for the various storm events. Other hydrologic modeling tools that employ different procedures may be used as well.

### 3.2.9 References

- ASTM International. 2006. Standard Guide for Selection, Installation and Maintenance of Plants for Green (Vegetated) Roof Systems. Standard E2400-06. ASTM, International. West Conshohocken, PA. available online: <http://www.astm.org/Standards/E2400.htm>.
- Clark, S., B. Long, C. Siu, J. Spicher and K. Steele. 2008. "Early-life runoff quality: green versus traditional roofs." Low Impact Development 2008. Seattle, WA. American Society of Civil Engineers.
- Dunnett, N. and N. Kingsbury. 2004. Planting Green Roofs and Living Walls. Timber Press. Portland, Oregon.
- Green Roof Infrastructure: Plants and Growing Medium 401. Participant Manual. [www.greenroofs.org](http://www.greenroofs.org)
- Luckett, K. 2009. Green Roof Construction and Maintenance. McGraw-Hill Companies, Inc.
- Northern Virginia Regional Commission (NVRC). 2007. Low Impact Development Manual. "Vegetated Roofs." Fairfax, VA.
- Snodgrass, E. and L. Snodgrass. 2006. Green Roof Plants: a resource and planting guide. Timber Press. Portland, OR.
- Weiler, S. and K. Scholz-Barth 2009. Green Roof Systems: A Guide to the Planning, Design, and Construction of Landscapes over Structure. Wiley Press. New York, NY.
- Virginia DCR Stormwater Design Specification No. 5: Vegetated Roof Version 2.2. 2010.

### 3.3 Rainwater Harvesting

**Definition.** Rainwater harvesting systems store and release rainfall for future use. Rainwater that falls on a rooftop or other impervious surface is collected and conveyed into an above- or below-ground storage tank (also referred to as a cistern or rain tank), where it can be used for non-potable water uses and on-site stormwater disposal/infiltration. Non-potable uses may include landscape irrigation, exterior washing (e.g., car washes, building facades, sidewalks, street sweepers, fire trucks), flushing of toilets and urinals, fire suppression (sprinkler systems), supply for cooling towers, evaporative coolers, fluid coolers and chillers, supplemental water for closed loop systems, steam boilers, replenishment of water features and water fountains, distribution to a green wall or living wall system, laundry, and delayed discharge to the combined sewer system.

In many instances, rainwater harvesting can be combined with a secondary (down-gradient) stormwater practice to enhance stormwater retention and/or provide treatment of overflow from the rainwater harvesting system. Some candidate secondary practices include:

- Disconnection to a pervious or conservation area (see Section 3.4 Impervious Surface Disconnection)
- Overflow to bioretention practices (see Section 3.6 Bioretention)
- Overflow to infiltration practices (see Section 3.8 Stormwater Infiltration)
- Overflow to grass channels or dry swales (see Section 3.12 Storage Practices)

By providing a reliable and renewable source of water to end users, rainwater harvesting systems can also have environmental and economic benefits beyond stormwater management (e.g., increased water conservation, water supply during drought and mandatory municipal water supply restrictions, decreased demand on municipal water supply, decreased water costs for the end-user, potential for increased groundwater recharge).

There are seven primary components of a rainwater harvesting system discussed in detail in Section 3.3.4. Some are depicted in Figure 3.2. The components include:

- Contributing Drainage Area (CDA) surface
- Collection and conveyance system (i.e., gutter and downspouts) (number 1 in Figure 3.2)
- Pre-Treatment including pre-screening and first flush diverters (number 2 in Figure 3.2)
- Storage tank (no number, but depicted in Figure 3.2)
- Water quality treatment (as required by TRAM)
- Distribution system
- Overflow, filter path or secondary stormwater retention practice (number 8 in Figure 3.2)

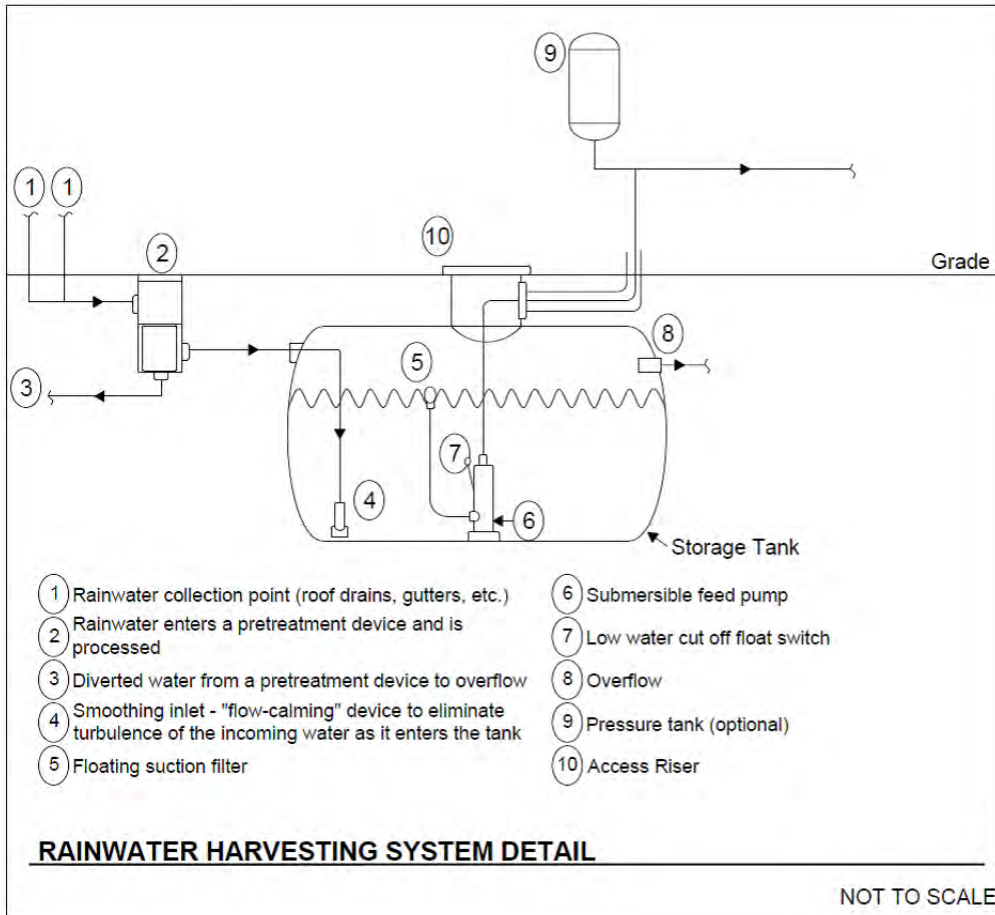


Figure 3.2 Example of a rainwater harvesting system detail.

### 3.3.1 Rainwater Harvesting Feasibility Criteria

A number of site-specific features influence how rainwater harvesting systems are designed and/or utilized. These should not be considered comprehensive and conclusive considerations but rather recommendations that should be considered during the process of planning to incorporate rainwater harvesting systems into the site design. The following are key considerations for rainwater harvesting feasibility:

**Plumbing Code.** This specification does not address indoor plumbing or disinfection issues. Designers and plan reviewers should consult the District Construction Codes (DCMR, Title 12) to determine the allowable indoor uses and required treatment for harvested rainwater. In cases where a municipal backup supply is used, rainwater harvesting systems must have backflow preventers or air gaps to keep harvested water separate from the main water supply. Distribution and waste pipes, internal to the building, must be stamped non-potable and colored purple consistent with District building codes. Pipes and spigots using rainwater must be clearly labeled as non-potable with an accompanying pictograph sign.

**Mechanical, Electrical, Plumbing (MEP).** For systems that call for indoor use of harvested rainwater, the seal of an MEP engineer is required.

**Water Use.** When rainwater harvesting will be used, a Tiered Risk Assessment Management (TRAM) (see Appendix N) must be completed and the appropriate form submitted to DDOE. This will outline the design assumptions, outline water quality risks and provide water quality end use standards.

**Available Space.** Adequate space is needed to house the storage tank and any overflow. Space limitations are rarely a concern with rainwater harvesting systems if they are considered during the initial building design and site layout of a residential or commercial development. Storage tanks can be placed underground, indoors, on rooftops that are structurally designed to support the added weight, and adjacent to buildings. Designers can work with architects and landscape architects to creatively site the tanks. Underground utilities or other obstructions should always be identified prior to final determination of the tank location.

**Site Topography.** Site topography and storage tank location should be considered as they relate to all of the inlet and outlet invert elevations in the rainwater harvesting system.

The final invert of the storage tank outlet pipe at the discharge point must match the invert of the receiving mechanism (e.g., natural channel, storm drain system) and be sufficiently sloped to adequately convey this overflow. The elevation drops associated with the various components of a rainwater harvesting system and the resulting invert elevations should be considered early in the design, in order to ensure that the rainwater harvesting system is feasible for the particular site.

Site topography and storage tank location will also affect pumping requirements. Locating storage tanks in low areas will make it easier to get water into the cisterns; however, it will increase the amount of pumping needed to distribute the harvested rainwater back into the building or to irrigated areas situated on higher ground. Conversely, placing storage tanks at higher elevations may require larger diameter pipes with smaller slopes but will generally reduce the amount of pumping needed for distribution. It is often best to locate a cistern close to the building or drainage area, to limit the amount of pipe needed.

**Available Hydraulic Head.** The required hydraulic head depends on the intended use of the water. For residential landscaping uses, the cistern may be sited up-gradient of the landscaping areas or on a raised stand. Pumps are commonly used to convey stored rainwater to the end use in order to provide the required head. When the water is being routed from the cistern to the inside of a building for non-potable use, often a pump is used to feed a much smaller pressure tank inside the building, which then serves the internal water demands. Cisterns can also use gravity to accomplish indoor residential uses (e.g., laundry) that do not require high water pressure.

**Water Table.** Underground storage tanks are most appropriate in areas where the tank can be buried above the water table. The tank should be located in a manner that is not subject to flooding. In areas where the tank is to be buried partially below the water table, special design features must be employed, such as sufficiently securing the tank (to keep it from floating), and

conducting buoyancy calculations when the tank is empty. The tank may need to be secured appropriately with fasteners or weighted to avoid uplift buoyancy. The combined weight of the tank and hold-down ballast must meet or exceed the buoyancy force of the tank. The tank must also be installed according to the tank manufacturer's specifications.

**Soils.** Storage tanks should only be placed on native soils or on fill in accordance with the manufacturer's guidelines. The bearing capacity of the soil upon which the cistern will be placed must be considered, as full cisterns can be very heavy. This is particularly important for above-ground cisterns, as significant settling could cause the cistern to lean or in some cases to potentially topple. A sufficient aggregate, or concrete foundation, may be appropriate depending on the soils and storage tank characteristics. Where the installation requires a foundation, the foundation must be designed to support the tank's weight when the cistern is full consistent with the bearing capacity of the soil and good engineering practice. The pH of the soil should also be considered in relation to its interaction with the cistern material.

**Proximity of Underground Utilities.** All underground utilities must be taken into consideration during the design of underground rainwater harvesting systems, treating all of the rainwater harvesting system components and storm drains as typical stormwater facilities and pipes. The underground utilities must be marked and avoided during the installation of underground tanks and piping associated with the system.

**Contributing Drainage Area.** The contributing drainage area (CDA) to the cistern is the impervious area draining to the tank. Rooftop surfaces are what typically make up the CDA, but paved areas can be used with appropriate treatment (oil/water separators and/or debris excluders). Areas of any size, including portions of roofs, can be used based on the sizing guidelines in this design specification. Runoff should be routed directly from the drainage area to rainwater harvesting systems in closed roof drain systems or storm drain pipes, avoiding surface drainage, which could allow for increased contamination of the water.

**Contributing Drainage Area Material.** The quality of the harvested rainwater will vary according to the roof material or drainage area over which it flows. Water harvested from certain types of rooftops and CDAs, such as asphalt sealcoats, tar and gravel, painted roofs, galvanized metal roofs, sheet metal, or any material that may contain asbestos may leach trace metals and other toxic compounds. In general, harvesting rainwater from such surfaces should be avoided. If a sealant or paint roof surface is desired, it is recommended to use one that has been certified for such purposes by the National Sanitation Foundation (ANSI/NSF standard).

**Water Quality of Rainwater.** Designers should also note that the pH of rainfall in the District tends to be acidic (ranging from 4.5 to 5.0), which may result in leaching of metals from roof surfaces, tank lining or water laterals, to interior connections. Once rainfall leaves rooftop surfaces, pH levels tend to be slightly higher, ranging from 5.5 to 6.0. Limestone or other materials may be added in the tank to buffer acidity, if desired.

**Hotspot Land Uses.** Harvesting rainwater can be an effective method to prevent contamination of rooftop runoff that would result from mixing it with ground-level runoff from a stormwater hotspot operation.



**Setbacks from Buildings.** Storage tank overflow devices must be designed to avoid causing ponding or soil saturation within 10 feet of building foundations. While most systems are generally sited underground and more than ten feet laterally from the building foundation wall, some cisterns are incorporated into the basement of a building or underground parking areas. In any case, tanks must be designed to be watertight to prevent water damage when placed near building foundations.

**Vehicle Loading.** Whenever possible, underground rainwater harvesting systems should be placed in areas without vehicle traffic or other heavy loading, such as deep earth fill. If site constraints dictate otherwise, systems must be designed to support the loads they will be subjected to.

### 3.3.2 Rainwater Harvesting Conveyance Criteria

**Collection and Conveyance.** The collection and conveyance system consists of the gutters, downspouts, and pipes that channel rainfall into storage tanks. Gutters and downspouts should be designed as they would for a building without a rainwater harvesting system. Aluminum, round-bottom gutters and round downspouts are generally recommended for rainwater harvesting. Typically, gutters should be hung at a minimum of 0.5 percent for 2/3 of the length and at 1 percent for the remaining 1/3 of the length in order to adequately convey the design storm (e.g., **Stormwater Retention Volume (SWRv)**). If the system will be used for management of the 2-year and 15-year storms, the gutters must be designed to convey the appropriate 2-year and 15-year storm intensities.

Pipes, which connect downspouts to the cistern tank, should be at a minimum slope of 1.5 percent and sized/ designed to convey the intended design storm, as specified above. In some cases, a steeper slope and larger sizes may be recommended and/or necessary to convey the required runoff, depending on the design objective and design storm intensity. Gutters and downspouts should be kept clean and free of debris and rust.

**Overflow.** An overflow mechanism must be included in the rainwater harvesting system design in order to handle an individual storm event or multiple storms in succession that exceed the capacity of the tank. Overflow pipe(s) must have a capacity equal to or greater than the inflow pipe(s) and have a diameter and slope sufficient to drain the cistern while maintaining an adequate freeboard height. The overflow pipe(s) must be screened to prevent access to the tank by rodents and birds. All overflow from the system must be directed to an acceptable flow path that will not cause erosion during a 2-year storm event.

### 3.3.3 Rainwater Harvesting Pretreatment Criteria

Pre-filtration is required to keep sediment, leaves, contaminants, and other debris from the system. Leaf screens and gutter guards meet the minimal requirement for pre-filtration of small systems, although direct water filtration is preferred. The purpose of pre-filtration is to significantly cut down on maintenance by preventing organic buildup in the tank, thereby decreasing microbial food sources.

Diverted flows (i.e., first flush diversion and/or overflow from the filter, if applicable) must be directed to an appropriate BMP or to a settling tank to remove sediment and pollutants prior to discharge from the site.

Various pretreatment devices are described below. In addition to the initial first flush diversion, filters have an associated efficiency curve that estimates the percentage of rooftop runoff that will be conveyed through the filter to the storage tank. If filters are not sized properly, a large portion of the rooftop runoff may be diverted and not conveyed to the tank at all. A design intensity of 1 inch/hour (for design storm = SWR<sub>v</sub>) must be used for the purposes of sizing pre-tank conveyance and filter components. This design intensity captures a significant portion of the total rainfall during a large majority of rainfall events (NOAA, 2004). If the system will be used for channel and flood protection, the 2-year and 15-year storm intensities must be used for the design of the conveyance and pre-treatment portion of the system. The Cistern Design Spreadsheet, discussed more in Section 3.3.4, allows for input of variable filter efficiency rates for the SWR<sub>v</sub> design storm. To meet the requirements to manage the 2-year and 15-year storms, a minimum filter efficiency of 90 percent must be met.

- **First Flush Diverters.** First flush diverters direct the initial pulse of rainfall away from the storage tank. While leaf screens effectively remove larger debris such as leaves, twigs, and blooms from harvested rainwater, first flush diverters can be used to remove smaller contaminants such as dust, pollen, and bird and rodent feces. Simple first flush diverters require active management, by draining the first flush water volume to a pervious area following each rainstorm.
- **Leaf Screens.** Leaf screens are mesh screens installed over either the gutter or downspout to separate leaves and other large debris from rooftop runoff. Leaf screens must be regularly cleaned to be effective; if not maintained, they can become clogged and prevent rainwater from flowing into the storage tanks. Built-up debris can also harbor bacterial growth within gutters or downspouts (TWDB, 2005).
- **Roof Washers.** Roof washers are placed just ahead of storage tanks and are used to filter small debris from harvested rainwater (see Figure 3.4). Roof washers consist of a tank, usually between 25 and 50 gallons in size, with leaf strainers and a filter with openings as small as 30-microns. The filter functions to remove very small particulate matter from harvested rainwater. All roof washers must be cleaned on a regular basis.
- **Hydrodynamic Separator.** For large scale applications, hydrodynamic separators and other styles can provide filtering of CDA rainwater from larger CDAs.

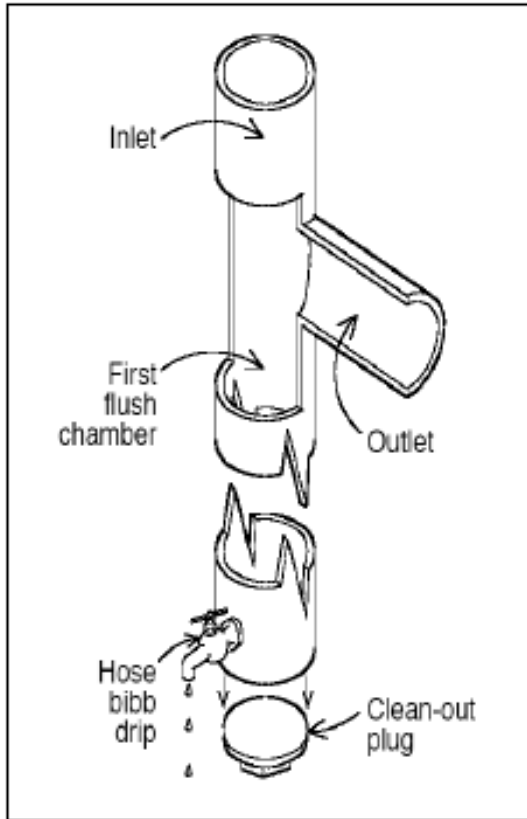


Figure 3.3 Diagram of a first flush diverter. (TWRB, 2005)

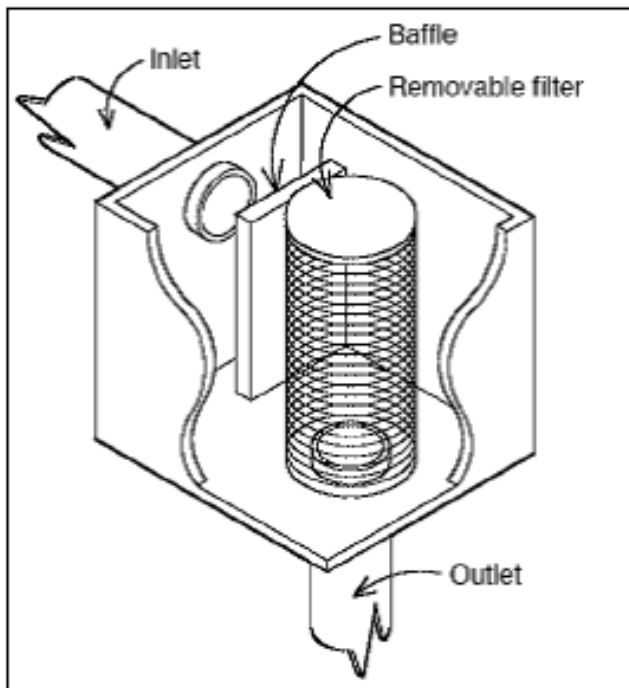


Figure 3.4 Diagram of a roof washer. (TWRB, 2005)

### 3.3.4 Rainwater Harvesting Design Criteria

System Components: Seven primary components of a rainwater harvesting system require special considerations (some of these are depicted in Figure 3.2):

- Contributing Drainage Area or CDA Surface
- Collection and conveyance system (i.e., gutter and downspouts)
- Pre-Treatment including pre-screening and first flush diverters
- Storage tank
- Water quality treatment (as required by TRAM)
- Distribution system
- Overflow, filter path or secondary stormwater retention practice

The system components are discussed below:

- **CDA Surface.** When considering CDA surfaces, note smooth, non-porous materials will drain more efficiently. Slow drainage of the CDA leads to poor rinsing and a prolonged first flush, which can decrease water quality. If the harvested rainwater will be directed towards uses with significant human exposure (e.g., pool filling, public sprinkler fountain), care should be taken in the choice of CDA materials. Some materials may leach toxic chemicals making the water unsafe for humans. In all cases, follow the advice of the TRAM found in Appendix N.

Rainwater can also be harvested from other impervious surfaces, such as parking lots and driveways; however, this practice requires more extensive pretreatment and treatment prior to reuse.

- **Collection and Conveyance System.** See Section 3.3.2 Rainwater Harvesting Conveyance Criteria.
- **Pre-Treatment.** See Section 3.3.3 Rainwater Harvesting Pretreatment Criteria.
- **Storage Tanks.** The storage tank is the most important and typically the most expensive component of a rainwater harvesting system. Cistern capacities generally range from 250 to 30,000 gallons but can be as large as 100,000 gallons or more for larger projects. Multiple tanks can be placed adjacent to each other and connected with pipes to balance water levels and to tailor the volume storage needed. Typical rainwater harvesting system capacities for residential use range from 1,500 to 5,000 gallons. Storage tank volumes are calculated to meet the water demand and stormwater storage volume retention objectives, as described further below in this specification.

While many of the graphics and photos in this specification depict cisterns with a cylindrical shape, the tanks can be made of many materials and configured in various shapes, depending on the type used and the site conditions where the tanks will be installed. For example, configurations can be rectangular, L-shaped, or step vertically to match the topography of a site. The following factors should be considered when designing a rainwater harvesting system and selecting a storage tank:

- ◆ Aboveground storage tanks should be UV and impact resistant.
- ◆ Underground storage tanks must be designed to support the overlying sediment and any other anticipated loads (e.g., vehicles, pedestrian traffic).
- ◆ Underground rainwater harvesting systems must have a standard size manhole or equivalent opening to allow access for cleaning, inspection, and maintenance purposes. The access opening must be installed in such a way as to prevent surface- or groundwater from entering through the top of any fittings, and must be secured/locked to prevent unwanted entry. Confined space safety precautions/requirements should be observed during cleaning, inspection, and maintenance.
- ◆ All rainwater harvesting systems must be sealed using a water-safe, non-toxic substance.
- ◆ Rainwater harvesting systems may be ordered from a manufacturer or can be constructed on-site from a variety of materials. Table 3.5 below compares the advantages and disadvantages of different storage tank materials.
- ◆ Storage tanks must be opaque or otherwise protected from direct sunlight to inhibit algae growth and must be screened to discourage mosquito breeding and reproduction.
- ◆ Dead storage below the outlet to the distribution system and an air gap at the top of the tank must be included in the total tank volume. For gravity-fed systems, a minimum of 6 inches of dead storage must be provided. For systems using a pump, the dead storage depth will be based on the pump specifications.
- ◆ Any hookup to a municipal backup water supply must have a backflow prevention device to keep municipal water separate from stored rainwater; this may include incorporating an air gap to separate the 2 supplies.

**Table 3.5 Advantages and Disadvantages of Typical Cistern Materials (Source: Cabell Brand Center, 2007; Cabell Brand Center, 2009)**

Tank Material	Advantages	Disadvantages
Fiberglass	Commercially available, alterable and moveable; durable with little maintenance; light weight; integral fittings (no leaks); broad application	Must be installed on smooth, solid, level footing; pressure proof for below-ground installation; expensive in smaller sizes
Polyethylene	Commercially available, alterable, moveable, affordable; available in wide range of sizes; can install above or below ground; little maintenance; broad application	Can be UV-degradable; must be painted or tinted for above-ground installations; pressure-proof for below- ground installation
Modular Storage	Can modify to topography; can alter footprint and create various shapes to fit site; relatively inexpensive	Longevity may be less than other materials; higher risk of puncturing of watertight membrane during construction
Plastic Barrels	Commercially available; inexpensive	Low storage capacity (20 to 50 gallons); limited application
Galvanized Steel	Commercially available, alterable, and moveable; available in a range of sizes; film develops inside to prevent corrosion	Possible external corrosion and rust; must be lined for potable use; can only install above ground; soil pH may limit underground applications
Steel Drums	Commercially available, alterable, and moveable	Small storage capacity; prone to corrosion, and rust can lead to leaching of metals;

Tank Material	Advantages	Disadvantages
		verify prior to reuse for toxics; water pH and soil pH may also limit applications
FerroConcrete	Durable and immovable; suitable for above or below ground installations; neutralizes acid rain	Potential to crack and leak; expensive
Cast in Place Concrete	Durable, immovable, and versatile; suitable for above or below ground installations; neutralizes acid rain	Potential to crack and leak; permanent; will need to provide adequate platform and design for placement in clay soils
Stone or concrete Block	Durable and immovable; keeps water cool in summer months	Difficult to maintain; expensive to build

- **Water Quality Treatment.** Depending upon the collection surface, method of dispersal, and proposed use for the harvested rainwater, a water quality treatment device may be required by the TRAM (see Appendix N).
- **Distribution Systems.** Most distribution systems require a pump to convey harvested rainwater from the storage tank to its final destination, whether inside the building, an automated irrigation system, or gradually discharged to a secondary stormwater treatment practice. The rainwater harvesting system should be equipped with an appropriately sized pump that produces sufficient pressure for all end-uses.
- The typical pump and pressure tank arrangement consists of a multi-stage centrifugal pump, which draws water out of the storage tank and sends it into the pressure tank, where it is stored for distribution. Some systems will not require this two tank arrangement (e.g., low pressure, gravel). When water is drawn out of the pressure tank, the pump activates to supply additional water to the distribution system. The backflow preventer is required to separate harvested rainwater from the main potable water distribution lines.
- Distribution lines from the rainwater harvesting system should be buried beneath the frost line. Lines from the rainwater harvesting system to the building should have shut-off valves that are accessible when snow cover is present. A drain plug or cleanout sump, must be installed to allow the system to be completely emptied, if needed. Above-ground outdoor pipes must be insulated or heat-wrapped to prevent freezing and ensure uninterrupted operation during winter if winter use is planned for.
- **Overflow.** See Section 3.3.2 Rainwater Harvesting Conveyance Criteria.

**Rainwater Harvesting Material Specifications.** The basic material specifications for rainwater harvesting systems are presented in Table 3.6 below. Designers should consult with experienced rainwater harvesting system and irrigation installers on the choice of recommended manufacturers of prefabricated tanks and other system components.

**Table 3.6 Design Specifications for Rainwater Harvesting Systems**

Item	Specification
Gutters and Downspouts	<p>Materials commonly used for gutters and downspouts include polyvinylchloride (PVC) pipe, vinyl, aluminum, and galvanized steel. Lead must not be used as gutter and downspout solder, since rainwater can dissolve the lead and contaminate the water supply.</p> <ul style="list-style-type: none"> <li>▪ The length of gutters and downspouts is determined by the size and layout of the catchment and the location of the storage tanks.</li> <li>▪ Be sure to include needed bends and tees.</li> </ul>
Pre-Treatment	<p>At least one of the following (all rainwater to pass through pre-treatment):</p> <ul style="list-style-type: none"> <li>▪ First flush diverter</li> <li>▪ Hydrodynamic separator</li> <li>▪ Roof washer</li> <li>▪ Leaf and mosquito screen (1 mm mesh size)</li> </ul>
Storage Tanks	<ul style="list-style-type: none"> <li>▪ Materials used to construct storage tanks must be structurally sound.</li> <li>▪ Tanks should be constructed in areas of the site where soils can support the load associated with stored water.</li> <li>▪ Storage tanks must be watertight and sealed using a water-safe, non-toxic substance.</li> <li>▪ Tanks must be opaque or otherwise shielded to prevent the growth of algae.</li> <li>▪ Tanks must be opaque or otherwise shielded to prevent the growth of algae.</li> <li>▪ The size of the rainwater harvesting system(s) is determined through design calculations.</li> </ul>

Note: This table does not address indoor systems or pumps.

**Design Objectives and System Configuration.** Many rainwater harvesting system variations can be designed to meet user demand and stormwater objectives. This specification focuses on providing a design framework for achieving the SWRV objectives for compliance with the regulations. From a rainwater harvesting standpoint, there are numerous potential configurations that could be implemented. However, in terms of addressing the design storm, this specification adheres to the following concepts in order to properly meet the stormwater retention goals:

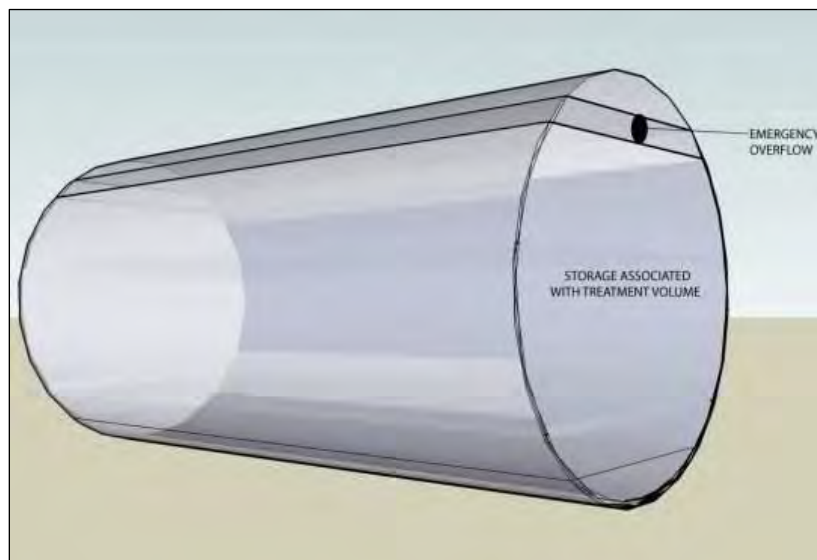
- System design is encouraged to use rainwater as a resource to meet on-site demand or in conjunction with other stormwater retention practices.
- Peak flow reduction is realized through reduced volume and temporary storage of runoff.

Therefore, the rainwater harvesting system design configurations presented in this specification are targeted for use of rainwater through internal use, seasonal irrigation, and other activities, such as cooling tower use, vehicle washing, etc. While many internal use results in a steady year-round demand for the harvested rainwater, seasonal irrigation, cooling towers, and some other uses will vary with the time of year, and the retention value is reduced accordingly.

**Design Objectives and Tank Design Set-Ups.** Pre-fabricated rainwater harvesting cisterns typically range in size from 250 to over 30,000 gallons. There are three basic tank design configurations used to meet the various rainwater harvesting system configurations that are described below.

- **Tank Design 1.** The first tank set-up (Figure 3.5) maximizes the available storage volume associated with the SWRV to meet the desired level of stormwater retention. This layout also maximizes the storage that can be used to meet a demand. An emergency overflow exists

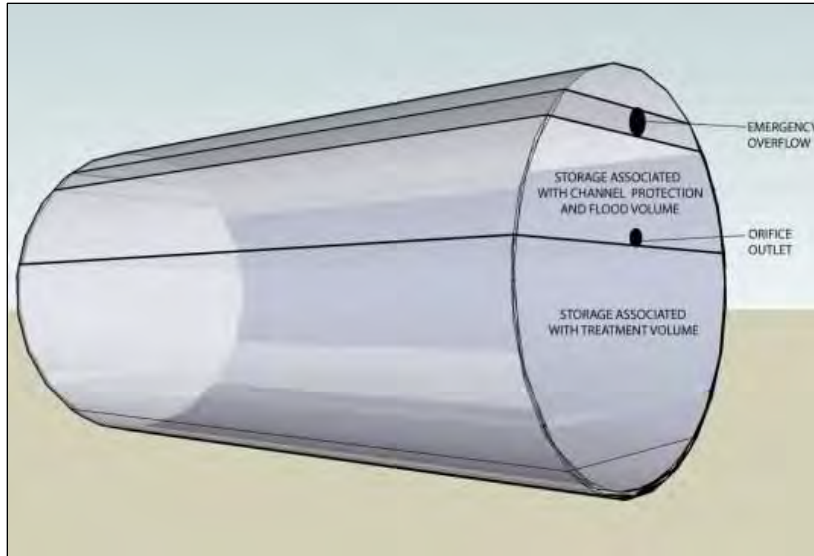
near the top of the tank as the only gravity release outlet device (not including the pump, manway, or inlets). It should be noted that it is possible to address 2-year and 15-year storm volumes with this tank configuration, but the primary purpose is to address the smaller SWR<sub>v</sub> design storm.



**Figure 3.5 Tank Design 1: Storage associated with the design storm volume only.**

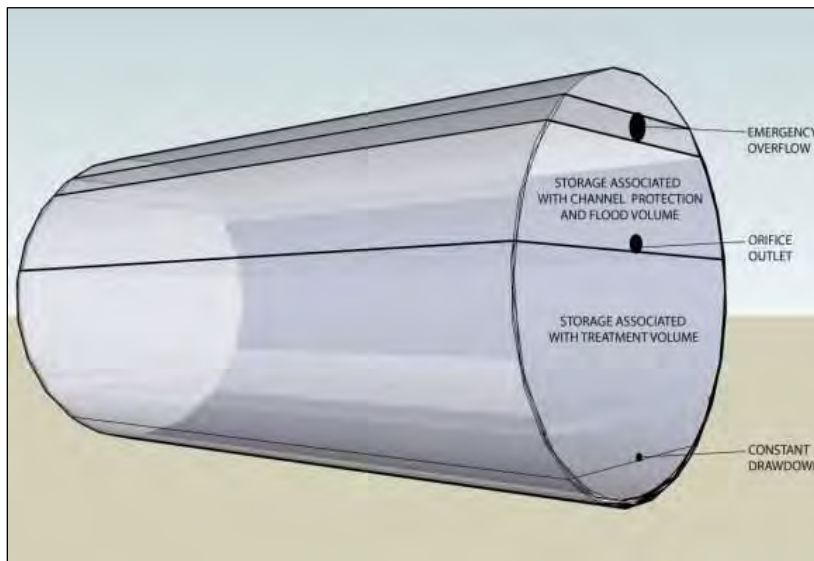
- **Tank Design 2.** The second tank set-up (Figure 3.6) uses tank storage to meet the SWR<sub>v</sub> storage objectives and also uses additional detention volume to meet some or all of the 2-year and 15-year storm volume requirements. An orifice outlet is provided at the top of the design storage for the SWR<sub>v</sub> level, and an emergency overflow is located at the top of the detention volume level.





**Figure 3.6 Tank Design 2: Storage associated with design storm, channel protection, and flood volume.**

- **Tank Design 3.** The third tank set-up (Figure 3.7) creates a constant drawdown within the system. The small orifice at the bottom of the tank needs to be routed to an appropriately designed secondary practice (i.e., bioretention, stormwater infiltration) that will allow the rainwater to be treated and allow for groundwater recharge over time. The release must not be discharged to a receiving channel or storm drain without treatment, and maximum specified drawdown rates from this constant drawdown should be adhered to, since the primary function of the system is not intended to be detention.



**Figure 3.7 Tank Design 3: Constant drawdown version where storage is associated with design storm, channel protection, and flood volume.**

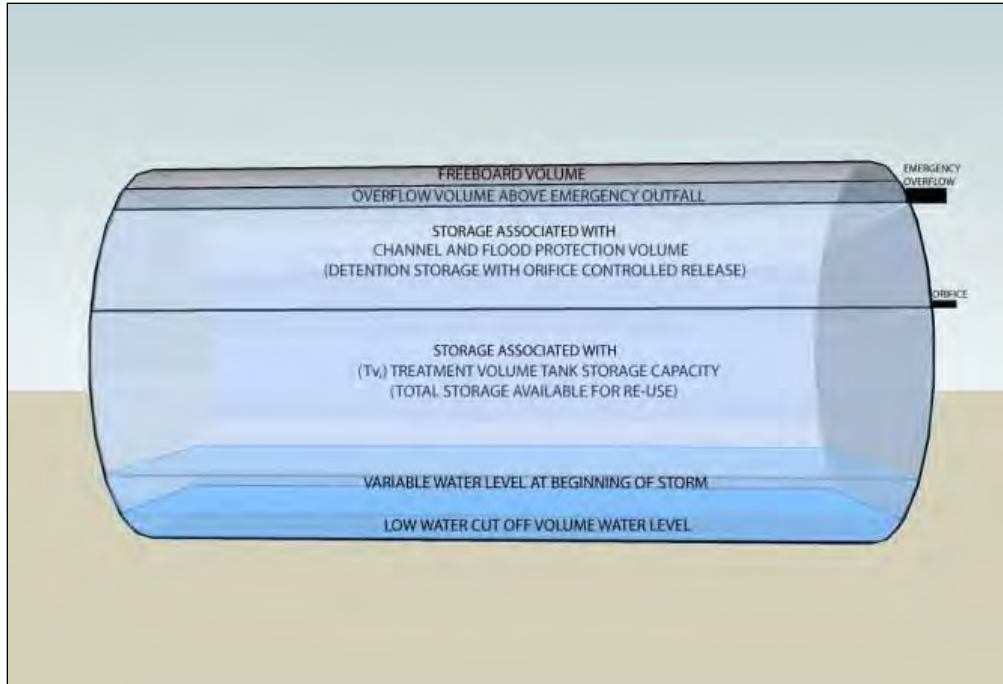
**Design Storm, Channel Protection and Flood Volume.** For the purposes of this tank design, the secondary practice must be considered a component of the rainwater harvesting system with regard to the storage volume percentage calculated in the Compliance Spreadsheet. In other words, the storage volume associated with the secondary practice must not be added (or double-counted) to the rainwater harvesting percentage because the secondary practice is an integral part of a rainwater harvesting system with a constant drawdown. The exception to this requirement would be if the secondary practice were also sized to capture and treat impervious and/or turf area beyond the area treated by rainwater harvesting (for example from the adjacent yard or a driveway). In this case, only these additional areas should be added into the Compliance Spreadsheet (details found in Chapter 5 and Appendix A) to receive retention volume achieved for the secondary practice.

While a small orifice is shown at the bottom of the tank in Figure 3.7, the orifice could be replaced with a pump that would serve the same purpose, conveying a limited amount of water to a secondary practice on a routine basis.

**Sizing of Rainwater Harvesting Systems.** The rainwater harvesting cistern sizing criteria presented in this section was developed using a spreadsheet model that used best estimates of indoor and outdoor water demand, long-term rainfall data, and CDA capture area data (Forasté2011). The Cistern Design Spreadsheet (CDS) is for cistern sizing guidance and to quantify the retention value for storage volume achieved. This retention value is required for input into the General Retention Compliance Spreadsheet and is part of the submission of a Stormwater Management Plan (SWMP) using rainwater harvesting systems for compliance. A secondary objective of the spreadsheet is to increase the beneficial uses of the stored stormwater, treating it as a valuable natural resource. More information on the CDS can be found later in this section. The spreadsheet can be found on DDOE's website.

**Incremental Design Volumes within Cistern.** Rainwater tank sizing is determined by accounting for varying precipitation levels, captured CDA runoff, first flush diversion (through filters) and filter efficiency, low water cut-off volume, dynamic water levels at the beginning of various storms, storage needed for the design storm (permanent storage), storage needed for 2-year or 15-year volume (temporary detention storage), seasonal and year-round demand use and objectives, overflow volume, and freeboard volumes above high water levels during very large storms. See Figure 3.8 for a graphical representation of these various incremental design volumes.

The design specification described in this section (Rainwater Harvesting) does not provide guidance for sizing larger storms (e.g., 15-year, Qf) but rather provides guidance on sizing for the SWRV design storms.



**Figure 3.8 Incremental design volumes associated with tank sizing.**

The “Storage Associated with the Retention Value” is the storage within the tank that is modeled and available for reuse. While the SWRV will remain the same for a specific CDA, the “Storage Associated with the Retention Value” may vary depending on demand and storage volume retention objectives. It includes the variable water level at the beginning of a storm and the low water cut-off volume that is necessary to satisfy pumping requirements.

**Cistern Design Spreadsheet (CDS).** The design specification provided in this section (Rainwater Harvesting) is linked with the CDS. The spreadsheet uses daily rainfall data from September 1, 1977 to September 30, 2007 to model performance parameters of the cistern under varying CDAs, demands on the system, and tank size.

The runoff that reaches the cistern each day is added to the water level that existed in the cistern the previous day, with all of the total demands subtracted on a daily basis. If any overflow is realized, the volume is quantified and recorded. If the tank runs dry (reaches the cut-off volume level), then the volume in the tank is fixed at the low level, and a dry-frequency day is recorded. The full or partial demand met in both cases is quantified and recorded. A summary of the water balance for the system is provided below.

### Water Contribution

- **Precipitation.** The volume of water contributing to the rainwater harvesting system is a function of the rainfall and drainage area captured, as defined by the designer.
- **Municipal Backup (optional).** In some cases, the designer may choose to install a municipal backup water supply to supplement tank levels. Note that municipal backups may also be

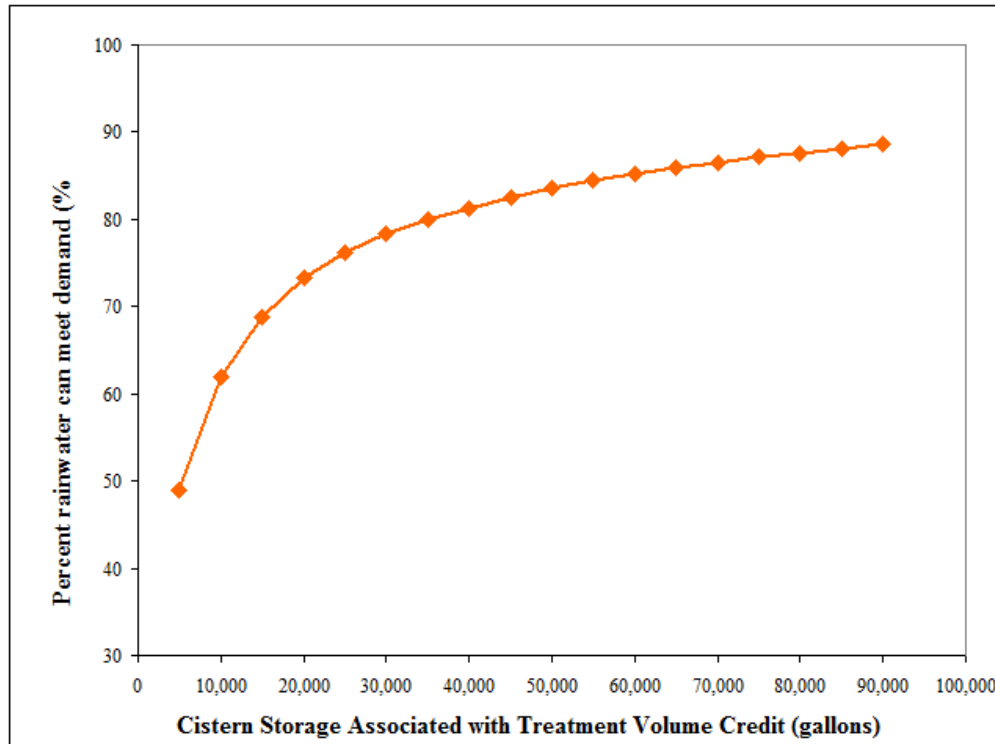
connected post-tank (i.e., a connection is made to the non-potable water line that is used for pumping water from the tank for reuse), thereby not contributing any additional volume to the tank. Municipal backup designs that supply water directly to the tank are not accounted for in the CDS.

### Water Losses

- **Drainage Area Runoff Coefficient.** The CDA is assumed to convey 95 percent of the rainfall that lands on its surface (i.e.,  $R_v = 0.95$ ).
- **First Flush Diversion.** The first 0.02 to 0.06 inches of rainfall that is directed to filters is diverted from the system in order to prevent clogging it with debris. This value is assumed to be contained within the filter efficiency rate.
- **Filter Efficiency.** It is assumed that, after the first flush diversion and loss of water due to filter inefficiencies, the remainder of the SWR<sub>v</sub> storm will be successfully captured. For the 1.2-inch storm, a minimum of 95 percent of the runoff should be conveyed into the tank. For the 3.2-inch storm, a minimum of 90 percent of the runoff should be conveyed. These minimum values are included as the filter efficiencies in the CDS, although they can be altered (increased) if appropriate. The CDS applies these filter efficiencies, or interpolated values, to the daily rainfall record to determine the volume of runoff that reaches the tank. For the purposes of selecting an appropriately sized filter, a rainfall intensity of 1 inch per hour shall be used for the SWR<sub>v</sub>. The appropriate rainfall intensity values for the 2-year (3.2-inch) and 15-year storms shall be used when designing for larger storm events.
- **Drawdown (Storage Volume).** This is the stored water within the cistern that is reused or directed to a secondary stormwater practice. It is the volume of runoff that is reduced from the CDA. This is the water loss that translates into the achievable storage volume retention.
- **Overflow.** For the purposes of addressing the SWR<sub>v</sub> (not for addressing larger storm volumes), orifice outlets for both detention and emergency overflows are treated the same. This is the volume of water that may be lost during large storm events or successive precipitation events.

**Results for all Precipitation Events.** The performance results of the rainwater harvesting system for all days during the entire period modeled, including the full spectrum of precipitation events, is included in the –Results” tab. This tab is not associated with determining the storage volume achieved, but instead may be a useful tool in assisting the user to realize the performance of the various rainwater harvesting system sizes with the design parameters and demands specified.

- **Percentage of Demand Met.** This is where the percentage of demand met for various size cisterns and CDA/demand scenarios is reported. A graph displaying the percentage of demand met versus the percentage of overflow frequency for various cistern sizes is provided in this tab. Normally, this graph assists the user in understanding the relationship between cistern sizes and optimal/diminishing returns. An example is provided below in Figure 3.9.



**Figure 3.9** Example of percent demand met versus cistern storage.

At some point, larger cisterns no longer provide significant increases in percentages of demand met. Conversely, the curve informs the user when a small increase in cistern size can yield a significant increase in the percentage of time that demand is met.

- **Dry Frequency.** Another useful measure is the dry frequency. If the cistern is dry a substantial portion of the time, this measure can inform the user that he/she may want to decrease the size of the cistern, decrease the demand on the system, or explore capturing more CDA to provide a larger supply, if feasible. It can also provide useful insight for the designer to determine whether he/she should incorporate a municipal backup supply to ensure sufficient water supply through the system at all times.
- **Overflow Frequency.** This is a metric of both overflow frequency and average volume per year for the full spectrum of rainfall events. This metric will inform the user regarding the design parameters, magnitude of demand, and associated performance of the system. If the system overflows at a high frequency, then the designer may want to increase the size of the cistern, decrease the CDA captured, or consider other mechanisms that could increase drawdown (e.g., increase the area to be irrigated, incorporate or increase on-site infiltration, etc.).
- **Inter-relationships and Curves of Diminishing Returns.** Plotting various performance metrics against one another can be very informative and reveal relationships that are not evident otherwise. An example of this usefulness is demonstrated when the plot of “percentage-of-demand-met versus tank size” is compared against the plot of “the percentage-of-overflow-frequency versus tank size”. By depicting these plots on the same

graph, a range of optimum cistern sizes emerges. This informs the designer where a small increase or decrease in tank size will have a significant impact on dry frequency and overflow frequency. Looking outside this range, will indicate where changes in cistern sizes will not have significant influence over dry frequency and overflow frequency, but may offer a large trade-off compared to the cost of the rainwater harvesting system.

**Results for Retention Value.** The retention value percentage of CDA runoff volume that the tank can capture for a 1.7-inch storm on an average daily basis given the water demands by the user is presented on the “Results-Retention Value” tab. This information is used to calculate the retention value percentage, which is used as an input to the Compliance Spreadsheet.

- **Retention Value Percentage Achieved.** The percentage of retention value achieved is calculated for multiple sizes of cisterns. A trade-off curve plots these results, which allows for a comparison of the retention achieved versus cistern size. While larger tanks yield more retention, they are more costly. The curve helps the user to choose the appropriate tank size, based on the design objectives and site needs, and to understand the rate of diminishing returns.
- **Overflow Volume.** The volume of the overflows resulting from a 1.7-inch precipitation event is also reported in this tab. A chart of the Retention Value and Overflow Frequency versus the Storage Volume is provided. An example is shown below in Figure 3.10.

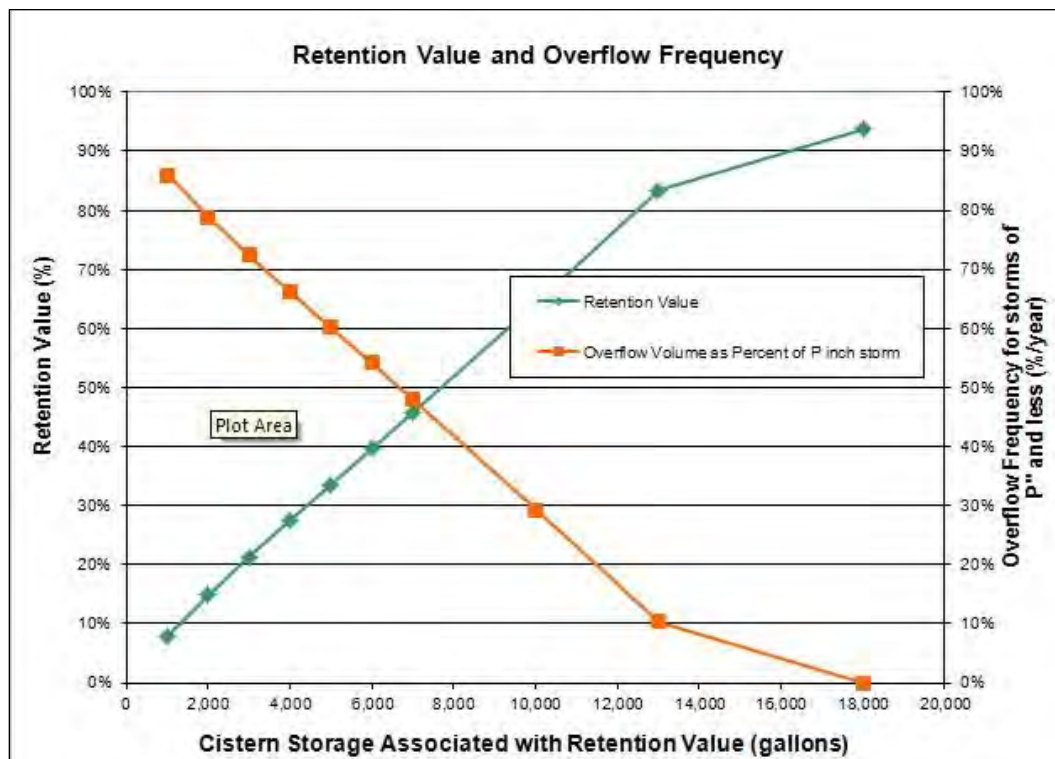


Figure 3.10 Example of retention value percentage achieved versus storage for non-potable uses.

These plotted results establish a trade-off relationship between these two performance metrics. In the previous example, a 13,000 gallon cistern optimizes the storage volume achieved and the overflow frequency (near the inflection point of both curves).

**Results from the Cistern Design Spreadsheet to be Transferred to the General Retention Compliance Spreadsheet.** There are two results from this Cistern Design Spreadsheet that are to be transferred to the General Retention Compliance Spreadsheet, as follows:

- **Contributing Drainage Area (CDA).** Enter the CDA that was used in the Cistern Design Spreadsheet in the same row into the Drainage Area columns in the blue cell (cell B26-D31).
- **Retention Value.** Once the cistern storage volume associated with the retention value has been selected, transfer that achieved percentage into the General Retention Compliance Spreadsheet column called “% Retention Value” in the “Rainwater Harvesting” row (cell I33).

**Completing the Sizing Design of the Cistern.** The total size of the cistern tank is the sum of the following four volume components:

- **Low Water Cutoff Volume (Included).** A dead storage area must be included so the pump will not run the tank dry. This volume is included in the Cistern Design Spreadsheet’s modeled volume.
- **Cistern Storage Associated with Design Volume (Included).** This is the design volume from the Cistern Design Spreadsheet.
- **Adding Channel Protection and Flood Volumes (Optional).** Additional detention volume may be added above and beyond the cistern storage associated with the design storm volumes for the 2-year or 15-year events. Typical routing software programs may be used to design for this additional volume.
- **Adding Overflow and Freeboard Volumes (Required).** An additional volume above the emergency overflow must be provided in order for the tank to allow very large storms to pass. Above this overflow water level, there will be an associated freeboard volume that should account for at least 5 percent of the overall tank size. Sufficient freeboard must be verified for large storms, and these volumes must be included in the overall size of the cistern tank.

### 3.3.5 Rainwater Harvesting Landscaping Criteria

If the harvested water is to be used for irrigation, the design plan elements must include the proposed delineation of planting areas to be irrigated, the planting plan, and quantification of the expected water demand. The default water demand for irrigation is 1.0 inches per week over the area to be irrigated. Justification must be provided if larger volumes are to be used.

### 3.3.6 Rainwater Harvesting Construction Sequence

**Installation.** It is advisable to have a single contractor to install the rainwater harvesting system, outdoor irrigation system, and secondary retention practices. The contractor should be familiar

with rainwater harvesting system sizing, installation, and placement. A licensed plumber is required to install the rainwater harvesting system components to the plumbing system.

A standard construction sequence for proper rainwater harvesting system installation is provided below. This can be modified to reflect different rainwater harvesting system applications or expected site conditions.

1. Choose the tank location on the site
2. Route all downspouts or pipes to pre-screening devices and first flush diverters
3. Properly install the tank
4. Install the pump (if needed) and piping to end-uses (indoor, outdoor irrigation, or tank dewatering release)
5. Route all pipes to the tank
6. Stormwater must not be diverted to the rainwater harvesting system until the overflow filter path has been stabilized with vegetation.

**Construction Supervision.** The following items should be inspected by a qualified professional prior to final sign-off and acceptance of a rainwater harvesting system:

- Rooftop area matches plans
- Diversion system is properly sized and installed
- Pretreatment system is installed
- Mosquito screens are installed on all openings
- Overflow device is directed as shown on plans
- Rainwater harvesting system foundation is constructed as shown on plans
- Catchment area and overflow area are stabilized
- Secondary stormwater treatment practice(s) is installed as shown on plans

DDOE's construction phase inspection checklist for rainwater harvesting practices can be found in Appendix L.

### **3.3.7 Rainwater Harvesting Maintenance Criteria**

**Maintenance Inspections.** Periodic inspections and maintenance shall be conducted for each system by a qualified professional.

DDOE's maintenance inspection checklists for rainwater harvesting systems can be found in Appendix M.

**Maintenance Schedule.** Maintenance requirements for rainwater harvesting systems vary according to use. Systems that are used to provide supplemental irrigation water have relatively low maintenance requirements, while systems designed for indoor uses have much higher



maintenance requirements. Table 3.7 describes routine maintenance tasks necessary to keep rainwater harvesting systems in working condition. Maintenance tasks must be performed by an “Inspector Specialist,” certified by the American Rainwater Catchment Association. Maintenance tasks must be documented and substantially comply with the maintenance responsibilities outlined in the declaration of covenants.

**Table 3.7 Typical Maintenance Tasks for Rainwater Harvesting Systems**

Responsible Person	Frequency	Activity
Owner	Four times a year	Inspect and clean pre-screening devices and first flush diverters
	Twice a year	Keep gutters and downspouts free of leaves and other debris
	Once a year	<ul style="list-style-type: none"> <li>▪ Inspect and clean storage tank lids, paying special attention to vents and screens on inflow and outflow spigots. Check mosquito screens and patch holes or gaps immediately</li> <li>▪ Inspect condition of overflow pipes, overflow filter path, and/or secondary stormwater treatment practices</li> </ul>
	Every third year	Clear overhanging vegetation and trees over roof surface
Qualified Third Party Inspector	According to Manufacturer	Inspect water quality devices
	As indicated in TRAM	Provide water quality analysis to DDOE
	Every third year	<ul style="list-style-type: none"> <li>▪ Inspect tank for sediment buildup</li> <li>▪ Check integrity of backflow preventer</li> <li>▪ Inspect structural integrity of tank, pump, pipe and electrical system</li> <li>▪ Replace damaged or defective system components</li> </ul>

**Mosquitoes.** In some situations, poorly designed rainwater harvesting systems can create habitat suitable for mosquito breeding and reproduction. Designers must provide screens on above- and below-ground tanks to prevent mosquitoes and other insects from entering the tanks. If screening is not sufficient in deterring mosquitoes, dunks or pellets containing larvicide can be added to cisterns when water is intended for landscaping use.

**Cold Climate Considerations.** Rainwater harvesting systems have a number of components that can be impacted by freezing winter temperatures. Designers should give careful consideration to these conditions to prevent system damage and costly repairs.

For above-ground systems, winter-time operation may be more challenging, depending on tank size and whether heat tape is used on piping. If not protected from freezing, these rainwater harvesting systems must be taken offline for the winter and stormwater treatment values may not be granted for the practice during that off-line period. At the start of the winter season, vulnerable above-ground systems that have not been designed to incorporate special precautions should be disconnected and drained. It may be possible to reconnect former roof leader systems for the winter.

For underground and indoor systems, downspouts and overflow components should be checked for ice blockages during snowmelt events.

**Declaration of Covenants.** A declaration of covenants that includes all maintenance responsibilities to ensure the continued stormwater performance for the BMP is required. The declaration of covenants specifies the property owner's primary maintenance responsibilities, and authorizes DDOE staff to access the property for inspection or corrective action in the event the proper maintenance is not performed. The declaration of covenants is attached to the deed of the property. An example form is provided at the end of Chapter 5 though variations will exist for scenarios where stormwater crosses property lines. The covenant is between the property and the District Government. It is submitted through the Office of the Attorney General (OAG). All SWMPs have a maintenance agreement stamp that must be signed for a building permit to proceed. A maintenance schedule must appear on the SWMP. Additionally, a maintenance schedule is required in schedule c of the declaration of covenants.

Covenants are not required on government properties, but maintenance responsibilities must be defined through a partnership agreement or a memorandum of understanding.

**Waste Material.** Waste material from the repair, maintenance, or removal of a BMP or land cover shall be removed and disposed of in compliance with applicable federal and District law.

### **3.3.8 Rainwater Harvesting: Stormwater Compliance Calculations**

Rainwater harvesting practices receive a partial retention value for the SWRV that is equivalent to the percent retention achieved (%) determined by using the CDS, as described in Section 3.3.4. Rainwater harvesting is not an accepted TSS removal practice.

### **3.3.9 References**

Cabell Brand Center. 2007. Virginia Rainwater Harvesting Manual. Salem, VA.  
<http://www.cabellbrandcenter.org>

Cabell Brand Center. 2009. Virginia Rainwater Harvesting Manual, Version 2.0. Salem, VA.  
(Draft Form) <http://www.cabellbrandcenter.org>

Forasté, J. Alex. 2011. District of Columbia Cistern Design Spreadsheet. Center for Watershed Protection, Inc.

National Oceanic and Atmospheric Administration (NOAA). 2004. NOAA Atlas 14  
Precipitation-Frequency Atlas of the United States, Volume 2, Version 3.0. Revised 2006.  
Silver Spring, MD.

Texas Regional Water Board (TWDB). 2005. The Texas Manual Rainwater Harvesting. Third  
Ed. Austin, TX.

### 3.4 Impervious Surface Disconnection

Definition. This strategy involves managing runoff close to its source by intercepting, infiltrating, filtering, treating or reusing it as it moves from an impervious surface to the drainage system. Disconnection practices can be used to reduce the volume of runoff that enters the combined or separate sewer systems. Two kinds of disconnection are allowed: (1) simple disconnection, whereby rooftops and/or on-lot residential impervious surfaces are directed to pervious areas or conservation areas, and (2) disconnection leading to an alternative retention practice(s) adjacent to the roof (see Figure 3.11). Alternative practices can use less space than simple disconnection and can enhance retention. Applicable practices include:

- D-1 Simple disconnection to pervious lands with the Compacted Cover designation
- D-2 Simple disconnection to lands with the Natural Cover designation
- D-3 Simple disconnection to a soil compost amended filter path
- D-4 Infiltration by small infiltration practices (dry wells or French drains) (see Section 3.8 Stormwater Infiltration)
- D-5 Filtration by rain gardens or stormwater planters (see Section 3.6 Bioretention)
- D-6 Storage and reuse with a cistern or other vessel (rainwater harvesting) (see Section 3.3 Rainwater Harvesting)

Disconnection practices reduce a portion of the stormwater retention volume (SWR<sub>v</sub>). In order to meet requirements for larger storm events, disconnection practices must be combined with additional practices.

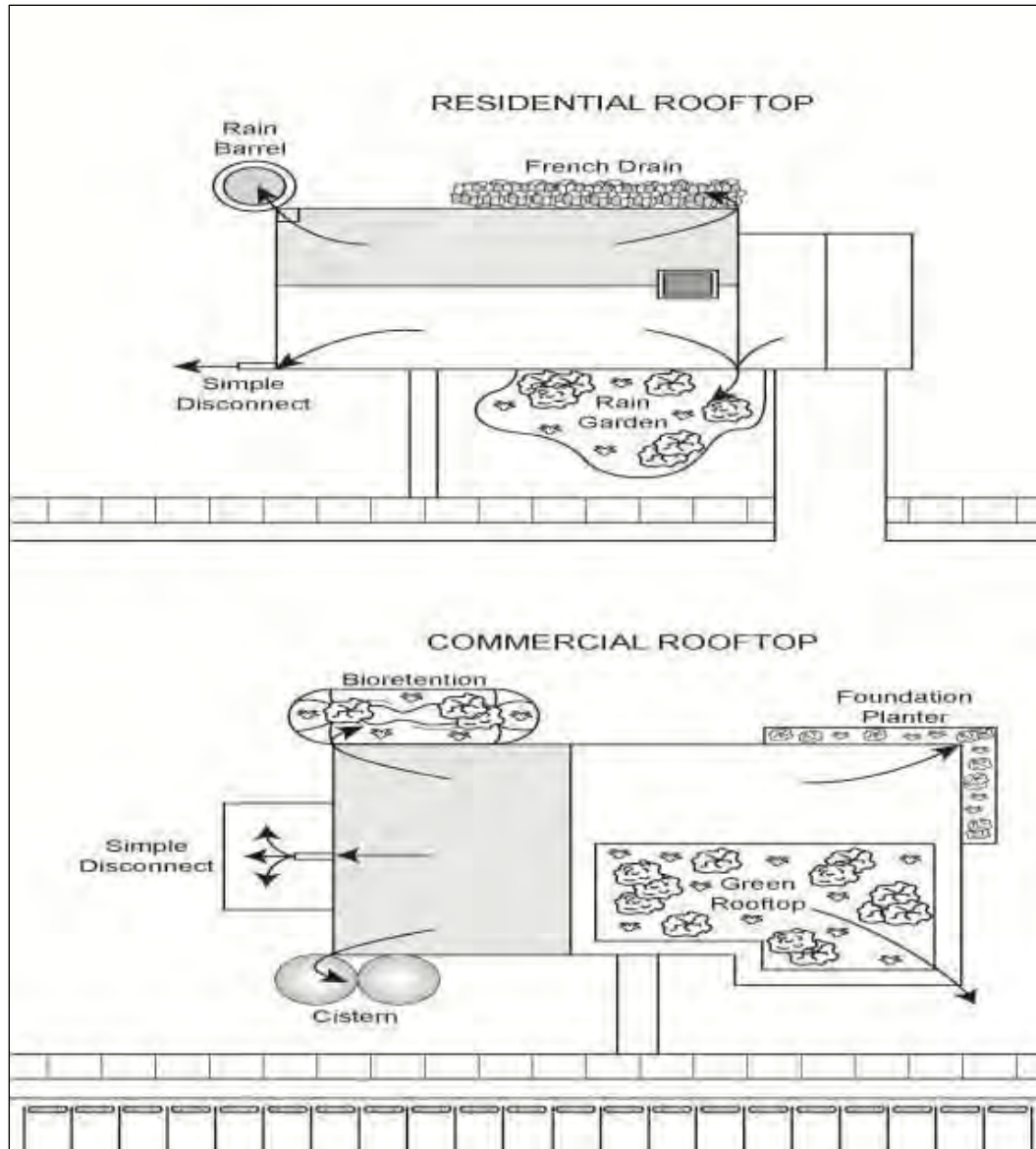


Figure 3.11 Roof disconnection with alternative retention practices

### 3.4.1 Impervious Surface Disconnection Feasibility Criteria

Impervious surface disconnections are ideal for use on commercial, institutional, municipal, multi-family residential and single-family residential buildings. Key constraints with impervious surface disconnections include available space, soil permeability, and soil compaction.

For disconnection to alternative practices (D-4, D-5, and D-6) consult the applicable sections for the alternative practices which are listed above. For simple disconnection to compacted cover or natural cover (D-1, D-2, and D-3) the following feasibility criteria exist (see Table 3.8):

**Contributing Drainage Area.** For rooftop impervious areas, the maximum impervious area treated cannot exceed 1,000 square feet per disconnection. For non-rooftop impervious areas, the longest contributing impervious area flow path cannot exceed 75 feet.

**Required Space.** Minimum 150 square feet of disconnection area.

**Sizing.** The available disconnection area must be at least 10 feet wide and 15 feet long. The disconnection width is limited to 25 feet unless the contributing runoff is conveyed via sheetflow or a level spreader. The disconnection length can be extended up to 100 feet to increase the retention value.

**Site Topography.** Simple disconnection is best applied when the grade of the receiving pervious area is less than 2 percent, or less than 5 percent with turf reinforcement. The slope of the receiving areas must be graded away from any building foundations. Turf reinforcement may include erosion control matting or other appropriate reinforcing materials that are confirmed by the designer to be non-erosive for the specific characteristics and flow rates anticipated at each individual application, and acceptable to the plan approving authority.

**Soils.** Impervious surface disconnection can be used on any post-construction Hydrologic Soil Group. The disconnection area must be kept well-vegetated with minimal bare spots—at least 95 percent soil cover (Section J – Vegetative Stabilization of DDOE’s Soil Erosion and Sediment Control Handbook).

**Building Setbacks.** If the grade of the receiving area is less than 1 percent, downspouts must be extended 5 feet away from building. Note that the downspout extension of 5 feet is intended for simple foundations. The use of a dry well or French drain adjacent to an in-ground basement or finished floor area requires an effective water-proofing system (e.g., foundation drains).

**Table 3.8 Feasibility Criteria for Simple Disconnection**

Design Factor	Disconnection Design
Contributing Drainage Area	1,000 square feet per rooftop disconnection. For non-rooftop impervious areas, the longest contributing impervious area flow path cannot exceed 75 feet.
Required Space	Minimum 150 square feet of disconnection area.
Sizing	The available disconnection area must be at least 10 feet wide and 15 feet long. Maximum disconnection width is 25 feet unless the contributing runoff is conveyed via sheetflow or a level spreader. Maximum disconnection length is 100 feet.
Site Topography	Grade of the receiving pervious area is less than 2%, or less than 5% with turf reinforcement. The slope of the receiving areas must be graded away from any building foundations.
Soils	Impervious surface disconnection can be used on any post-construction Hydrologic Soil Group. The disconnection area must be kept well-vegetated with minimal bare spots.
Building Setbacks	5 feet away from building if the grade of the receiving area is less than 1%

### 3.4.2 Impervious Surface Disconnection Conveyance Criteria

Simple disconnection practices (D-1, D-2, D-3) areas require a design that safely conveys the 2-year and 15-year storm events over the receiving area without causing erosion. In some applications, erosion control matting or other appropriate reinforcing materials may be needed to control flow rates anticipated for larger design storms.

For disconnection to alternative practices, consult the appropriate specifications for information on ensuring proper conveyance of larger storms through the practices.

### 3.4.3 Impervious Surface Disconnection Pretreatment Criteria

Pretreatment is not needed for simple impervious surface disconnection. For disconnection to alternative practices, external downspout pretreatment is recommended (e.g., leaf screens).

### 3.4.4 Impervious Surface Disconnection Design Criteria

The following design criteria apply to each disconnection practice:

**(D-1) Simple Disconnection to a Pervious Area with the Compacted Cover Designation.** Disconnection to pervious areas with the compacted cover designation is required to meet the feasibility criteria presented above in Section 3.4.1.

During site construction, care must be taken not to compact the receiving pervious area. To prevent soil compaction, heavy vehicular and foot traffic must be kept out of the receiving pervious area both during and after construction. This can be accomplished by clearly delineating the receiving pervious areas on all development plans and protecting them with temporary fencing prior to the start of land-disturbing activities (see Appendix O for guidance on protecting natural and compacted cover designations during construction). If compaction occurs, soil amendments or post-construction aeration will be required (see Appendix K on soil amendments).

**(D-2) Simple Disconnection to a Conservation Area with Natural Cover Designation.** Disconnection to conservation areas are required to meet the feasibility criteria presented in Section 3.4.1, with the following additional additions/exceptions:

- Minimum disconnection length: 40 feet.
- Maximum slope of the receiving area: 6 percent. (2 percent for the first 10 feet)
- Inflow must be conveyed via sheet flow or via a level spreader.
- If inflow conveyed via sheet flow, maximum disconnection length is 75 feet if runoff is conveyed from an impervious area and 150 feet if runoff is conveyed from a pervious area;
- If inflow conveyed via level spreader, the maximum disconnection length is 150 feet and the level spreader must be designed with an appropriate width as specified below.
- Retention value applies only to areas directly receiving sheet flow or directly perpendicular to the level spreader.

A level spreader can be used to disperse or “spread” concentrated flow thinly over a vegetated or forested area to promote greater runoff infiltration in the receiving area. A level spreader consists of a permanent linear structure constructed at a 0 percent grade that transects the slope. The influent concentrated runoff must be spread over an area wide enough area so that erosion of the receiving area does not result. Detailed information on the design and function of level spreaders can be found in Hathaway and Hunt, 2006 and Van Der Wiele, 2007.

The minimum required width of the level spreader is

- 13 linear feet per each 1 cubic foot/second of inflow if the receiving conservation area has 90 percent ground cover
- 40 linear feet per 1 cubic foot/second of inflow if the receiving conservation area is forested

**(D-3) Simple Disconnection to a Soil Compost-Amended Filter Path.** Consult Appendix K for detailed information on the design and function of soil compost amendments. The incorporation of compost amendments must meet the design criteria in the specification and include the following design elements:

- Flow from the downspout must spread over a 10-foot wide strip extending down-gradient along the flow path from the building to the street or conveyance system.
- The filter path must be a minimum 15 feet in length.
- Installation of a pea gravel or river stone diaphragm, or other accepted flow spreading device is required at the downspout outlet to distribute flows evenly across the filter path.
- The strip requires adequate freeboard so that flow remains within the strip and is not diverted away from the strip. In general, this means that the strip should be lower than the surrounding land area in order to keep flow in the filter path. Similarly, the flow area of the filter strip must be level to discourage concentrating the flow down the middle of the filter path.
- Use 2 to 4 inches of compost and till to a depth of 6 to 10 inches within the filter path.

**(D-4) Infiltration by Small Infiltration Practices.** Depending on soil properties, roof runoff may be infiltrated into a shallow dry well or French drain. The design for this alternative must meet the requirements of infiltration practices, as described in Section 3.8 and summarized in Table 3.9 below. Note that the building setback of 5 feet is intended for simple foundations. The use of a dry well or French drain adjacent to an in-ground basement or finished floor area should be carefully designed and coordinated with the design of the structure’s water-proofing system (e.g., foundation drains), or avoided altogether.

**Table 3.9 Design Criteria for Disconnection to Small-scale Infiltration**

Design Factor	Infiltration Design
Roof Area Treated	250 to 2,500 square feet
Typical Practices	Dry Well and French Drain
Recommended Maximum Depth	3 feet
Sizing	See Section 3.8 Stormwater Infiltration
Observation Well	No
Type of Pretreatment	External (leaf screens, grass strip, etc)
UIC Permit Needed	Not typically <sup>1</sup>
Head Required	Nominal, 1 to 3 feet
Required Soil Test	One per practice
Building Setbacks	10 feet from structure <sup>2</sup> , unless an impermeable liner is used

<sup>1</sup> Infiltration practice must be wider than it is deep. See Section 3.8 Stormwater Infiltration for more information.

<sup>2</sup> Note that the building setback is intended for simple foundations. The use of a dry well or French drain adjacent to an in-ground basement or finished floor area should be carefully designed and coordinated with the design of the structure’s water-proofing system (e.g., foundation drains), or avoided altogether.

In general, micro-infiltration areas will require a surface area up to 3 percent of the contributing roof area. An on-site soil test is needed to determine if soils are suitable for infiltration.

**(D-5) Filtration by Rain Gardens or Stormwater Planters.** For some residential applications, front, side, and/or rear yard bioretention may be an attractive option used to filter roof runoff (see Figure 3.12). Stormwater planters are also a useful option to disconnect and treat rooftop runoff, particularly in ultra-urban areas. The designs for these options must meet the requirements of stormwater planters (B-4) or rain gardens (B-5), as described in Section 3.6 and summarized in Table 3.10 below.



**Figure 3.12 Demonstration sites exist throughout the District to promote downspout disconnection, removing impervious pavement, and promoting native plants.**



**Table 3.10 Design Criteria for Disconnection to Small-scale Bioretention (D-5)**

Design Factor	Bioretention Design
Impervious Area Treated <sup>1</sup>	1,000 square feet
Type of Inflow	Sheetflow or roof leader
Observation Well/ Cleanout Pipes	No
Type of Pretreatment	External (e.g., leaf screens)
Underdrain	Optional per soils <sup>1</sup>
Gravel Layer	12 inches
Minimum Filter Media Depth	18 inches
Media Source	Can be mixed on site
Head Required	Nominal, 1 to 3 feet
Sizing	See Section 3.6 Bioretention
Required Soil Test	One per practice
Building Setbacks	10 feet from structure unless an impermeable liner is used

<sup>1</sup>Refer to Section 3.6 Bioretention

**(D-6) Storage and Reuse with a Cistern or Rain Tank.** This form of disconnection must conform to the design requirements outlined in Section 3.3. The retention rates for rain tanks and cisterns depends on their storage capacity and ability to draw down water in between storms for reuse as potable water, grey-water or irrigation use. The actual retention rate for a particular design can be ascertained using the design spreadsheet referenced in Section 3.3. All devices must have a suitable overflow area to route extreme flows into the next treatment practice or the stormwater conveyance system.

### 3.4.5 Impervious Surface Disconnection Landscaping Criteria

All receiving disconnection areas must be stabilized to prevent erosion or transport of sediment to receiving practices or drainage systems. Several appropriate types of grasses for disconnection practices area are listed in Table 3.11. Designers must ensure that the maximum flow velocities do not exceed the values listed in the table for the selected grass species and the specific site slope. If using vegetation outside of this table, the designer must provide documentation to ensure excessive erosion will not occur. Additionally, see the DDOE Soil Erosion and Sediment Control Handbook (Section J – Vegetative Stabilization) for vegetation suggestions.

**Table 3.11 Recommended Vegetation for Pervious Disconnection Areas**

Vegetation Type	Slope (%)	Maximum Velocity (ft/s)	
		Erosion resistant soil	Easily Eroded Soil
Bermuda Grass	< 5	8	6
	5–10	7	5
	> 10	6	4
Kentucky Bluegrass	< 5	7	5
	5–10	6	4
	> 10	5	3
Tall Fescue Grass Mixture	< 5	6	4
	5–10	4	3
Annual and Perennial Rye	0–5	4	3
Sod	0–5	4	3

Source: USDA, TP-61, 1954; City of Roanoke Virginia Stormwater Design Manual, 2008.

### 3.4.6 Impervious Surface Disconnection Construction Sequence

**Construction Sequence for Disconnection to Pervious Areas.** For simple disconnection to a pervious area, the pervious area can be within the limits of disturbance (LOD) during construction. The following procedures should be followed during construction:

- Before site work begins, the receiving pervious disconnection area boundaries should be clearly marked.
- Construction traffic in the disconnection area should be limited to avoid compaction. The material stockpile area shall not be located in the disconnection area.
- Construction runoff should be directed away from the proposed disconnection area, using perimeter silt fence, or, preferably, a diversion dike.
- If existing topsoil is stripped during grading, it shall be stockpiled for later use.
- The disconnection area may require light grading to achieve desired elevations and slopes. This should be done with tracked vehicles to prevent compaction.
- Topsoil and or compost amendments should be incorporated evenly across the disconnection area, stabilized with seed, and protected by biodegradable erosion control matting or blankets.
- Stormwater must not be diverted into any compost amended areas until the area is stabilized, which is defined as having groundcover of 95 percent or greater by the DDOE Soil Erosion and Sediment Control Handbook (Section J – Vegetative Stabilization).

**Construction Sequence for Disconnection to Conservation Areas.** For simple disconnection to a conservation area, the conservation area must be fully protected during the construction stage of development and kept outside the LOD on the Erosion and Sediment (E&S) Control Plan.

- No clearing, grading or heavy equipment access is allowed in the conservation area except temporary disturbances associated with incidental utility construction, restoration operations or management of nuisance vegetation.
- Any conservation areas shall be protected by super silt fence, chain link fence, orange safety fence, or other measures to prevent sediment discharge.
- The LOD must be clearly shown on all construction drawings and identified and protected in the field by acceptable signage, silt fence, snow fence or other protective barrier.
- If a level spreader is to be used in the design, construction of the level spreader shall not commence until the contributing drainage area has been stabilized and perimeter E&S controls have been removed and cleaned out. Further, stormwater must not be diverted into the disconnection area until the level spreader is installed and stabilized.

**Construction Supervision.** Construction supervision is recommended to ensure compliance with design standards. A qualified professional should evaluate the performance of the disconnection after the first big storm to look for evidence of gullies, outflanking, undercutting or sparse vegetative cover. Spot repairs should be made, as needed.

DDOE's construction phase inspection checklist for impervious cover disconnection can be found in Appendix L.

### 3.4.7 Impervious Surface Disconnection Maintenance Criteria

Maintenance of disconnected downspouts usually involves the regular lawn or landscaping maintenance in the filter path from the roof to the street. In some cases, runoff from a simple disconnection may be directed to a more natural, undisturbed setting (i.e., where lot grading and clearing is "fingerprinted" and the proposed filter path is protected). Typical maintenance activities include erosion control of the receiving area and ensuring the receiving area remains uncompacted and pervious.

DDOE's maintenance inspection checklists for disconnection can be found in Appendix M.

**Declaration of Covenants.** A declaration of covenants that includes all maintenance responsibilities to ensure the continued stormwater performance for the BMP is required. The declaration of covenants specifies the property owner's primary maintenance responsibilities, and authorizes DDOE staff to access the property for inspection or corrective action in the event the proper maintenance is not performed. The declaration of covenants is attached to the deed of the property. An example form is provided at the end of Chapter 5 though variations will exist for scenarios where stormwater crosses property lines. The covenant is between the property and the District Government. It is submitted through the Office of the Attorney General (OAG). All SWMPs have a maintenance agreement stamp that must be signed for a building permit to proceed. A maintenance schedule must appear on the SWMP. Additionally, a maintenance schedule is required in schedule c of the declaration of covenants.

Covenants are not required on government properties, but maintenance responsibilities must be defined through a partnership agreement or a memorandum of understanding.

**Waste Material.** Waste material from the repair, maintenance, or removal of a BMP or land cover shall be removed and disposed of in compliance with applicable federal and District law.

### 3.4.8 Disconnection Stormwater Compliance Calculations

Disconnection practices receive the following retention values:

- D-1 Simple disconnection to a pervious compacted cover area: retention value of 2 cubic feet per 100 square foot of receiving pervious area.
- D-2 Simple disconnection to a conserved natural cover area: retention value of 6 cubic feet per 100 square foot of receiving pervious conservation area.
- D-3 Simple disconnection to a soil compost amended filter path: retention value of 4 cubic feet per 100 square foot of receiving pervious conservation area.
- D-4. Infiltration by small infiltration practices (dry wells or French drains): see compliance criteria for Section 3.8.
- D-5 Filtration by rain gardens or stormwater planters: see compliance criteria for Section 3.6.
- D-6 Storage and reuse with a cistern or other vessel (rainwater harvesting): see compliance criteria for Section 3.3.

Note: The surface areas for practices D-1 and D-3 are considered compacted cover for purposes of retention calculations, and the surface area of practice D-2 is considered natural cover.

Simple disconnection practices are not accepted TSS treatment practices (see Table 3.12).

**Table 3.12 Disconnection Retention Value and Pollutant Removal**

Type of Simple Disconnection	Retention Value (gal) per 100 ft <sup>2</sup> of pervious receiving area	Accepted TSS Treatment Practice
To a pervious compacted cover area	15	No
To a conserved natural cover area	45	No
To a soil compost amended filter path	30	No

Impervious surface disconnection also contributes to peak flow reduction. This contribution can be determined in several ways. One method is to subtract the Retention Value from the total runoff volume for the 2-year, 15-year, and 100-year storms. The resulting reduced runoff volumes can then be used to calculate a Reduced Natural Resource Conservation Service (NRCS) Curve Number for the site or drainage area. The Reduced Curve Number can then be used to calculate peak flow rates for the various storm events. Other hydrologic modeling tools that employ different procedures may be used as well.

### 3.4.9 References

- City of Roanoke Virginia. 2007. Stormwater Design Manual. Department of Planning and Building and Development. Available online at:  
[http://www.roanokeva.gov/85256A8D0062AF37/vwContentByKey/47E4E4ABDDC5DA16852577AD0054958C/\\$File/Table%20of%20Contents%20%26%20Chapter%201%20Design%20Manual%2008.16.10.pdf](http://www.roanokeva.gov/85256A8D0062AF37/vwContentByKey/47E4E4ABDDC5DA16852577AD0054958C/$File/Table%20of%20Contents%20%26%20Chapter%201%20Design%20Manual%2008.16.10.pdf)
- District Department of Transportation (DDOT). Design and Engineering Manual 2009.
- Hathaway, J.M. and Hunt, W.F. 2006. Level Spreaders: Overview, Design, and Maintenance. Urban Waterways Design Series. North Carolina Cooperative Extension Service. Raleigh, NC. Available online:  
<http://www.bae.ncsu.edu/stormwater/PublicationFiles/LevelSpreaders2006.pdf>
- United States Department of Agriculture (USDA). 1954. Handbook of channel design for soil and water conservation. SCS-TP-61. Washington, DC. Available online:  
<ftp://ftp.wcc.nrcs.usda.gov/wntsc/H&H/TRsTPs/TP61.pdf>
- Van Der Wiele, C.F. 2007. Level Spreader Design Guidelines. North Carolina Division of Water Quality (NCDWQ). Revised 2010. Stormwater Best Management Practices Manual: Chapter 8 - Level Spreader & Vegetative Filter Strip.  
<http://portal.ncdenr.org/web/wq/ws/su/bmp-ch8>
- Virginia DCR Stormwater Design Specification No. 1: Rooftop (Impervious Surface) Disconnection Version 1.8. 2010.

### 3.5 Permeable Pavement Systems

**Definition.** Alternative paving surfaces that capture and temporarily store the Stormwater Retention Volume (SWRv) by filtering runoff through voids in the pavement surface into an underlying stone reservoir. Filtered runoff may be collected and returned to the conveyance system, or allowed to partially infiltrate into the soil.

Design variants include:

- P-1 Porous asphalt (PA)
- P-2 Pervious concrete (PC)
- P-3 Permeable pavers (PP)

Other variations of permeable pavement that are DDOE-approved permeable pavement surface materials are also encompassed in this section.

Permeable pavement systems are not typically designed to provide stormwater detention of larger storms (e.g., 2-year, 15-year), but they may be in some circumstances. Permeable pavement practices shall generally be combined with a separate facility to provide those controls.

There are two different types of permeable pavement design configurations:

- **Standard Designs.** Practices with a standard underdrain design and no infiltration sump or water quality filter (see Figure 3.13).
- **Enhanced Designs.** Practices with underdrains that contain a water quality filter layer and an infiltration sump beneath the underdrain sized to drain the design storm in 48 hours (see Figure 3.14) or practices with no underdrains that can infiltrate the design storm volume in 48 hours (see Figure 3.15).

The particular design configuration to be implemented on a site is typically dependent on specific site conditions and the characteristics of the underlying soils. These criteria are further discussed below.

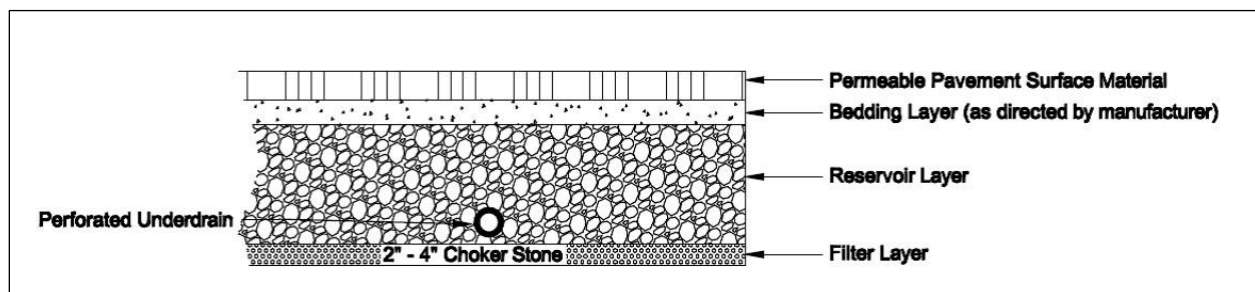


Figure 3.13 Cross section of a standard permeable pavement design.

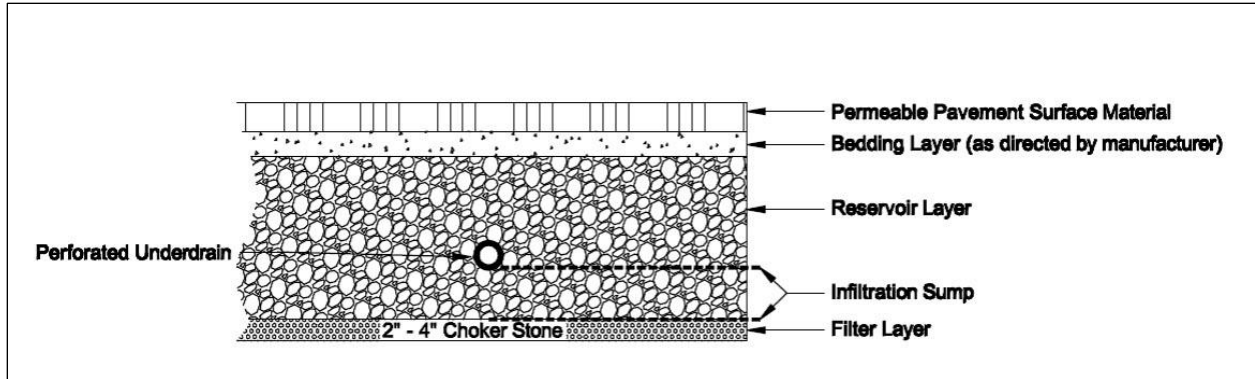


Figure 3.14 Cross section of an enhanced permeable pavement design with an underdrain.

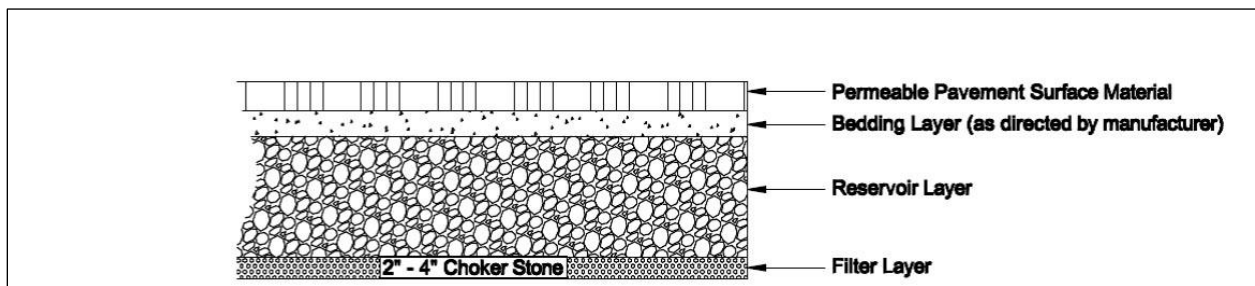


Figure 3.15 Cross section of an enhanced standard permeable pavement design without an underdrain

### 3.5.1 Permeable Pavement Feasibility Criteria

Since permeable pavement has a very high retention capability, it should always be considered as an alternative to conventional pavement. Permeable pavement is subject to the same feasibility constraints as most infiltration practices, as described below.

**Required Space.** A prime advantage of permeable pavement is that it does not normally require additional space at a new development or redevelopment site, which can be important for tight sites or areas where land prices are high.

**Soils.** Soil conditions do not typically constrain the use of permeable pavement, although they do determine whether an underdrain is needed. Underdrains may be required if the measured permeability of the underlying soils is less than 0.5 in./hr (although utilization of an infiltration sump may still be feasible). When designing an infiltrating permeable pavement practice, designers must verify soil permeability by using the on-site soil investigation methods provided in Appendix P. Impermeable soils will require an underdrain.

In fill soil locations, geotechnical investigations are required to determine if the use of an impermeable liner and underdrain are necessary or if the use of an infiltration sump is permissible (see Section 3.5.4 Permeable Pavement Design Criteria).

**Contributing Drainage Area.** The portion of the contributing drainage area that does not include the permeable pavement may not exceed 5 times the surface area of the permeable pavement (2 times is recommended), and it should be as close to 100 percent impervious as possible.

**Pavement Surface Slope.** Steep pavement surface slopes can reduce the stormwater storage capability of permeable pavement and may cause shifting of the pavement surface and base materials. The permeable pavement slope must be less than 5 percent. Designers may consider using a terraced design for permeable pavement in areas with steeper slopes. In all cases, designs must ensure that the slope of the pavement does not lead to flow occurring out of the stone reservoir layer onto lower portions of the pavement surface.

**Minimum Hydraulic Head.** The elevation difference needed for permeable pavement to function properly is generally nominal, although 2 to 4 feet of head from the pavement surface to the underdrain outlet is typically necessary. This value may vary based on several design factors, such as required storage depth and underdrain location.

**Minimum Depth to Water Table.** A high groundwater table may cause runoff to pond at the bottom of the permeable pavement system. Therefore, a minimum vertical distance of 2 feet must be provided between the bottom of the permeable pavement installation (i.e., the bottom invert of the reservoir layer) and the seasonal high water table.

**Setbacks.** To avoid the risk of seepage, permeable pavement practices must not be hydraulically connected to structure foundations. Setbacks to structures must be at least 10 feet, and adequate water-proofing protection must be provided for foundations and basements. Where the 10-foot setback is not possible, an impermeable liner may be used along the sides of the permeable pavement practice (extending from the surface to the bottom of the practice).

**Proximity to Utilities.** Interference with underground utilities should be avoided, if possible. When large site development is undertaken the expectation of achieving avoidance will be high. Conflicts may be commonplace on smaller sites and in the public right-of-way. Consult with each utility company on recommended offsets, which will allow utility maintenance work with minimal disturbance to the permeable paving BMP. For permeable paving BMPs in the public right-of-way a consolidated presentation of the various utility offset recommendations can be found in Chapter 33.14.5 of the District of Columbia Department of Transportation Design and Engineering Manual, latest edition. Consult the District of Columbia Water and Sewer Authority Green Infrastructure Utility Protection Guidelines, latest edition, for water and sewer line recommendations. Where conflicts cannot be avoided, follow these guidelines:

1. Consider altering the location or sizing of the permeable paving BMP to avoid or minimize the utility conflict. Consider an alternate BMP type to avoid conflict.
2. Use design features to mitigate the impacts of conflicts that may arise by allowing the permeable paving BMP and the utility to co-exist. The permeable paving design may need to incorporate impervious areas, through geotextiles or compaction, to protect utility crossings. Other a key design feature may need to be moved or added or deleted



3. Work with the utility to evaluate the relocation of the existing utility and install the optimum placement and sizing of the permeable paving BMP.
4. If utility functionality, longevity and vehicular access to manholes can be assured accept the permeable paving design and location with the existing utility. Incorporate into the permeable pavement design sufficient soil coverage over the utility or general clearances or other features such as an impermeable linear to assure all entities the conflict is limited to maintenance.

Note: When accepting utility conflict into the permeable paving location and design, it is understood the permeable paving will be temporarily impacted during utility work but the utility will replace the permeable paving or, alternatively, install a functionally comparable permeable paving according to the specifications in the current version of this Stormwater Management Guidebook. If the permeable paving is located in the public right-of-way the permeable paving restoration will also conform with the District of Columbia Department of Transportation Design and Engineering Manual with special attention to Chapter 33, Chapter 47 and the Design and Engineering Manual supplements for Low Impact Development and Green Infrastructure Standards and Specifications.

**Hotspot Land Uses.** Permeable pavements may not be used to treat hotspot runoff. For a list of potential stormwater hotspot operations, consult Appendix Q.

On sites with existing contaminated soils, as indicated in Appendix Q, infiltration is not allowed. Permeable pavement installations must include an impermeable liner, and the Enhanced Design configuration cannot be used.

**High Loading Situations.** Permeable pavement is not intended to treat sites with high sediment or trash/debris loads, since such loads will cause the practice to clog and fail. Sites with a lot of pervious area (e.g., newly established turf and landscaping) can be considered high loading sites and the pervious areas should be diverted if possible from the permeable pavement area. If unavoidable, pretreatment measures, such as a gravel or sod filter strip should be employed (see Section 3.5.3 Permeable Pavement Pretreatment Criteria).

**High Speed Roads.** Permeable pavement should not be used for high speed roads, although it has been successfully applied for low speed residential streets, parking lanes, and roadway shoulders.

### 3.5.2 Permeable Pavement Conveyance Criteria

Permeable pavement designs must include methods to convey larger storms (e.g., 2-year, 15-year) to the storm drain system. The following is a list of methods that can be used to accomplish this:

- Place an overdrain—a perforated pipe horizontally near the top of the reservoir layer—to pass excess flows after water has filled the base.
- Increase the thickness of the top of the reservoir layer by as much as 6 inches to increase storage (i.e., create freeboard). The design computations used to size the reservoir layer often assume that no freeboard is present.

- Create underground detention within the reservoir layer of the permeable pavement system. Reservoir storage may be augmented by corrugated metal pipes, plastic or concrete arch structures, etc.
- Route overflows to another detention or conveyance system.
- Set the storm drain inlets flush with the elevation of the permeable pavement surface to effectively convey excess stormwater runoff past the system. The design should also make allowances for relief of unacceptable ponding depths during larger rainfall events.

### 3.5.3 Permeable Pavement Pretreatment Criteria

Pretreatment for most permeable pavement applications is not necessary. Additional pretreatment is recommended if the pavement receives run-on from adjacent pervious areas. For example, a gravel or sod filter strip can be placed adjacent to pervious (landscaped) areas to trap coarse sediment particles before they reach the pavement surface in order to prevent premature clogging.

### 3.5.4 Permeable Pavement Design Criteria

**Type of Surface Pavement.** The type of pavement should be selected based on a review of the pavement specifications and properties and designed according to the product manufacturer's recommendations.

**Pavement Bottom Slope.** For unlined designs, the bottom slope of a permeable pavement installation should be as flat as possible (i.e., 0 percent longitudinal and lateral slopes) to enable even distribution and infiltration of stormwater. On sloped sites, internal check dams or berms, as shown in the diagram Figure 3.16 below, can be incorporated into the subsurface to encourage infiltration. In this type of design, the depth of the infiltration sump would be the depth behind the check dams.

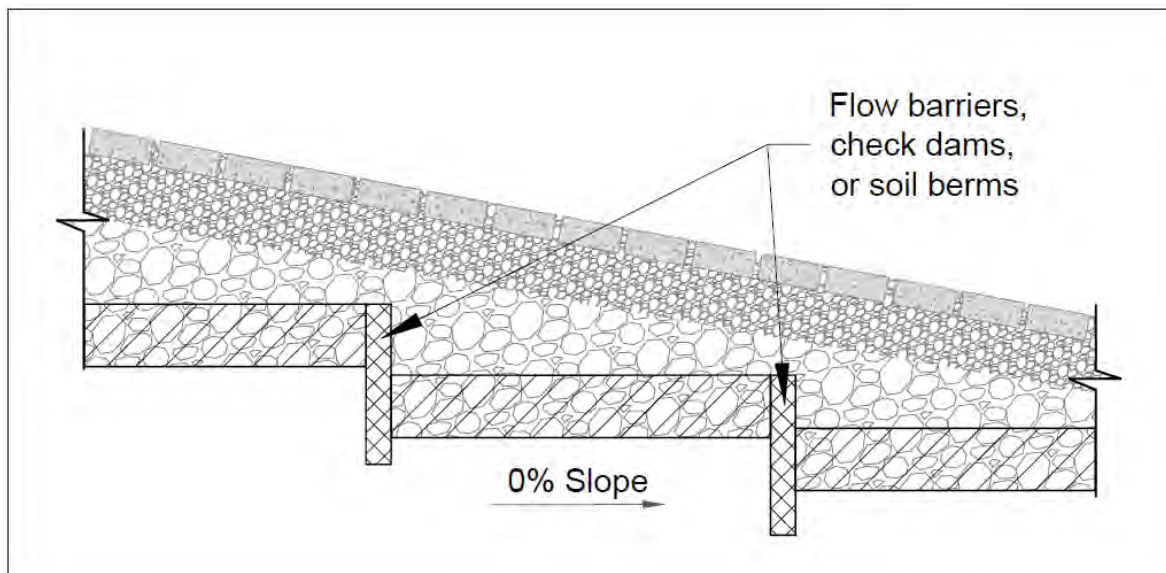


Figure 3.16 Use of flow barriers to encourage infiltration on sloped sites.

### **Internal Geometry and Drawdowns.**

- **Rapid Drawdown.** Permeable pavement must be designed so that the target storage volume is detained in the reservoir for as long as possible—36 to 48 hours—before completely discharging through an underdrain. A minimum orifice size of 1 inch is recommended regardless of the calculated drawdown time.

Note: A 48-hour maximum drawdown time is utilized for permeable pavement rather than the 72-hour value used for other BMPs. This shorter drawdown time, in accordance with industry standards, is intended to ensure that the subgrade does not stay saturated for too long and cause problems with the pavement.

- **Infiltration Sump.** To promote greater retention for permeable pavement located on marginal soils, an infiltration sump can be installed to create a storage layer below the underdrain invert. This design configuration is discussed further below.
- **Conservative Infiltration Rates.** Designers must use 1/2 of the measured infiltration rate during design to approximate long-term infiltration rates (for example, if the measured infiltration rate is 0.7 inches per hour, the design infiltration rate will be 0.35 inches per hour). This requirement is included in Equation 3.2 through Equation 3.4.

**Reservoir Layer.** The reservoir layer consists of the stone underneath the pavement section and above the bottom filter layer or underlying soils, including the optional infiltration sump. The total thickness of the reservoir layer is determined by runoff storage needs, the infiltration rate of in situ soils, structural requirements of the pavement sub-base, depth to water table and bedrock, and frost depth conditions (see Section 3.5.1 Permeable Pavement Feasibility Criteria). A geotechnical engineer should be consulted regarding the suitability of the soil subgrade.

- The reservoir below the permeable pavement surface should be composed of clean, double-washed stone aggregate and sized for both the storm event to be treated and the structural requirements of the expected traffic loading (additional chamber structures may also be used to create larger storage volumes).
- The storage layer may consist of clean, double-washed No. 57 stone, although No. 2 stone is preferred because it provides additional structural stability. Other appropriate materials may be used if accepted by DDOE.
- The bottom of the reservoir layer should be completely flat so that runoff will be able to infiltrate evenly through the entire surface. The use of terracing and check dams is permissible.

**Underdrains.** Most permeable pavement designs will require an underdrain (see Section 3.5.1 Permeable Pavement Feasibility Criteria). Underdrains can also be used to keep detained stormwater from flooding permeable pavement during extreme events. Multiple underdrains are necessary for permeable pavement wider than 40 feet, and each underdrain must be located 20 feet or less from the next pipe or the edge of the permeable pavement. (For long and narrow applications, a single underdrain running the length of the permeable pavement is sufficient.) The underdrain should be perforated schedule 40 PVC pipe (corrugated HDPE may be used for smaller load-bearing applications), with 3/8-inch perforations at 6 inches on center. The underdrain must be encased in a layer of clean, washed No. 57 stone, with a minimum 2-inch

cover over the top of the underdrain. The underdrain system must include a flow control to ensure that the reservoir layer drains slowly (within 36-48 hours).

- The underdrain outlet can be fitted with a flow-reduction orifice within a weir or other easily inspected and maintained configuration in the downstream manhole as a means of regulating the stormwater detention time. The minimum diameter of any orifice is 1 inch. The designer should verify that the volume will draw down completely within 36-48 hours.
- On infiltration designs, an underdrain(s) can be installed and capped at the downstream structure as an option for future use if maintenance observations indicate a reduction in the soil permeability.

All permeable pavement practices must include observation wells. The observation well is used to observe the rate of drawdown within the reservoir layer following a storm event and to facilitate periodic inspection and maintenance. The observation wells should consist of a well-anchored, perforated 4- to 6-inch (diameter) PVC pipe that is tied into any Ts or Ys in the underdrain system. The well should extend vertically to the bottom of the reservoir layer and extend upwards to be flush with the surface (or just under pavers) with a lockable cap.

**Infiltration Sump (optional, required for underdrained Enhanced Designs).** For unlined permeable pavement systems, an optional upturned elbow or elevated underdrain configuration can be used to promote greater retention for permeable pavement located on marginal soils (see Figure 3.14). The infiltration sump must be installed to create a storage layer below the underdrain or upturned elbow invert. The depth of this layer must be sized so that the design storm can infiltrate into the subsoils in a 48-hour period. The bottom of the infiltration sump must be at least 2 feet above the seasonally high water table. The inclusion of an infiltration sump is not permitted for designs with an impermeable liner. In fill soil locations, geotechnical investigations are required to determine if the use of an infiltration sump is permissible.

In order to improve the infiltration rate of the sump, it may be designed as a series of 1-foot wide trenches spread 5 feet apart, which are excavated after compaction of the existing soils is performed. Excavation of these trenches may allow access to less compacted, higher permeability soils and improve the effectiveness of the infiltration sump (Brown and Hunt, 2009). Regardless of the infiltration sump design, the infiltration rate must be field verified.

**Filter Layer (optional).** To protect the bottom of the reservoir layer from intrusion by underlying soils, a filter layer can be used. The underlying native soils should be separated from the stone reservoir by a 2 to 4 inch layer of choker stone (e.g., No. 8).

**Geotextile (optional).** Geotextile fabric is another option to protect the bottom of the reservoir layer from intrusion by underlying soils, although some practitioners recommend avoiding the use of fabric beneath permeable pavements since it may become a future plane of clogging within the system. Geotextile fabric is still recommended to protect the excavated sides of the reservoir layer, in order to prevent soil piping. An appropriate geotextile fabric that complies with AASHTO M-288 Class 2, latest edition, requirements, and has a permeability of at least an order of magnitude higher (10x) than the soil subgrade permeability must be used.

**Impermeable Liner.** An impermeable liner is not typically required, although it may be utilized in fill applications where deemed necessary by a geotechnical investigation, on sites with contaminated soils, or on the sides of the practice to protect adjacent structures from seepage. Use a 30-mil (minimum) PVC geomembrane liner. (Follow manufacturer’s instructions for installation.) Field seams must be sealed according to the liner manufacturer’s specifications. A minimum 6-inch overlap of material is required at all seams.

**Material Specifications.** Permeable pavement material specifications vary according to the specific pavement product selected. A general comparison of different permeable pavements is provided in Table 3.13 below, but designers should consult manufacturer’s technical specifications for specific criteria and guidance. Table 3.14 describes general material specifications for the component structures installed beneath the permeable pavement. Note that the size of stone materials used in the reservoir and filter layers may differ depending on the type of surface material.

**Table 3.13 Permeable Pavement Specifications for a Variety of Typical Surface Materials**

Material	Specification	Notes
Permeable Pavers (PP)	Void content, thickness, and compressive strength vary based on type and manufacturer  Open void fill media: aggregate, topsoil and grass, coarse sand, etc.	Reservoir layer required to support the structural load.
Pervious Concrete (PC)	Void content: 15% to 25%. Thickness: typically 4 to 8 inches. Compressive strength: 2.8 to 28 MPa. Open void fill media: None	May not require a reservoir layer to support the structural load, but a layer may be included to increase the storage or infiltration.
Porous Asphalt (PA)	Void content: 15% to 20%. Thickness: typically 3 to 7 in. (depending on traffic load). Open void fill media: None.	Reservoir layer required to support the structural load.

**Table 3.14 Material Specifications for Typical Layers Beneath the Pavement Surface**

Material	Specification	Notes
Bedding Layer	PC: 3 to 4 inches of No. 57 stone if No. 2 stone is used for Reservoir Layer  PA: 3 to 4 inches of No. 57 stone  PP: Follow manufacturer specifications	ASTM D448 size No. 8 stone (e.g., 3/8 to 3/16 inch in size). Must be double-washed and clean and free of all fines.

Material	Specification	Notes
Reservoir Layer	PC: No. 57 stone or No. 2 stone PA: No. 2 stone PP: Follow manufacturer specifications	ASTM D448 size No. 57 stone (e.g., 1 1/2 to 1/2-inch in size); No. 2 Stone (e.g., 3 inches to 3/4 inches in size). Depth is based on the pavement structural and hydraulic requirements. Must be double-washed and clean and free of all fines. Other appropriate materials may be used if accepted by DDOE.
Underdrain	Use 4- to 6-inch diameter perforated PVC pipe (or equivalent corrugated HDPE may be used for smaller load-bearing applications), with 3/8-inch perforations at 6 inches on center. Perforated pipe installed for the full length of the permeable pavement cell, and non-perforated pipe, as needed, is used to connect with the storm drain system. T's and Y's should be installed as needed, depending on the underdrain configuration. Extend cleanout pipes to the surface.	
Infiltration Sump (optional)	An aggregate storage layer below the underdrain invert. The material specifications are the same as Reservoir Layer.	
Filter Layer (optional)	The underlying native soils should be separated from the stone reservoir by a 2 to 4 inch layer of choker stone (e.g., No. 8).	
Geotextile (optional)	Use an appropriate geotextile fabric that complies with AASHTO M-288 Class 2, latest edition, requirements, and has a permeability of at least an order of magnitude higher (10x) than the soil subgrade permeability.	
Impermeable Liner (optional)	Where appropriate use a thirty mil (minimum) PVC Geomembrane liner (follow manufacturer's instructions for installation)	
Observation Well	Use a perforated 4- to 6-inch vertical PVC pipe (AASHTO M 252) with a lockable cap, installed flush with the surface.	

**Permeable Pavement Sizing.** The thickness of the reservoir layer is determined by both a structural and hydraulic design analysis. The reservoir layer serves to retain stormwater and also supports the design traffic loads for the pavement. Permeable pavement structural and hydraulic sizing criteria are discussed below.

**Structural Design.** If permeable pavement will be used in a parking lot or other setting that involves vehicles, the pavement surface must be able to support the maximum anticipated traffic load. The structural design process will vary according to the type of pavement selected, and the manufacturer's specific recommendations should be consulted. The thickness of the permeable pavement and reservoir layer must be sized to support structural loads and to temporarily store the design storm volume (e.g., the water quality, channel protection, and/or flood control volumes). On most new development and redevelopment sites, the structural support requirements will dictate the depth of the underlying stone reservoir.

The structural design of permeable pavements involves consideration of four main site elements:

- Total traffic

- In-situ soil strength
- Environmental elements
- Bedding and Reservoir layer design

The resulting structural requirements may include, but are not limited to, the thickness of the pavement, filter, and reservoir layer. Designers should note that if the underlying soils have a low California Bearing Ratio (CBR) (less than 4 percent), they may need to be compacted to at least 95 percent of the Standard Proctor Density, which may limit their use for infiltration.

Designers should determine structural design requirements by consulting transportation design guidance sources, such as the following:

- AASHTO Guide for Design of Pavement Structures (1993)
- AASHTO Supplement to the Guide for Design of Pavement Structures (1998)

**Hydraulic Design.** Permeable pavement is typically sized to store the SWRv or larger design storm volumes in the reservoir layer. The storage volume in the pavements must account for the underlying infiltration rate and outflow through any underdrains. The design storm should be routed through the pavement to accurately determine the required reservoir depth. The depth of the reservoir layer or infiltration sump needed to store the design storm can be determined by using Equation 3.2.

**Equation 3.2 Reservoir Layer or Infiltration Sump Depth**

$$d_p = \frac{\left( \frac{P \times Rv_i \times DA}{A_p} \right) - \left( \frac{i}{2} \times t_f \right)}{\eta_r}$$

where:

- $d_p$  = depth of the reservoir layer (or depth of the infiltration sump for enhanced designs with underdrains) (ft)
- $P$  = rainfall depth for the SWRv or other design storm (ft)
- $Rv_i$  = runoff coefficient for impervious cover (0.95)
- $DA$  = total drainage area, including contributing drainage area and permeable pavement surface area (ft<sup>2</sup>)
- $A_p$  = permeable pavement surface area (ft<sup>2</sup>)
- $i$  = field-verified infiltration rate for the subgrade soils (ft/day). If an impermeable liner is used in the design then  $i = 0$ .
- $t_f$  = time to fill the reservoir layer (day) (assume 2 hours or 0.083 day)
- $\eta_r$  = effective porosity for the reservoir layer (0.35)

This equation makes the following design assumptions:

- The contributing drainage area (DA) does not contain pervious areas.

- For design purposes, the field-tested subgrade soil infiltration rate ( $i$ ) is divided by 2 as a factor of safety to account for potential compaction during construction. If the subgrade will be compacted to meet structural design requirements of the pavement section, the design infiltration rate of the subgrade soil shall be based on measurement of the infiltration rate of the subgrade soil subjected to the compaction requirements.
- The porosity ( $\eta_r$ ) for No. 57 stone is 0.35.

The depth of the reservoir layer cannot be less than the depth required to meet the pavement structural requirement. The depth of the reservoir layer may need to be increased to meet structural or larger storage requirements.

Designers must ensure that the captured volume will drain from the pavement in 36 to 48 hours. For infiltration designs (no underdrains) or designs with infiltration sumps, Equation 3.3 can be used to determine the drawdown time in the reservoir layer or infiltration sump.

**Equation 3.3 Drawdown Time**

$$t_d = \frac{d_p \times \eta_r}{\left(\frac{i}{2}\right)} = \frac{d_p \times \eta_r \times 2}{i}$$

where:

- $t_d$  = drawdown time (specify unit of measure)
- $d_p$  = depth of the reservoir layer (or the depth of the infiltration sump, for enhanced designs with underdrains) (ft)
- $\eta_r$  = effective porosity for the reservoir layer (0.35)

For design with underdrains, the drawdown time should be determined using the hydrological routing or modeling procedures used for detention systems with the depth and head adjusted for the porosity of the aggregate.

The total storage volume provided by the practice,  $S_v$ , should be determined using Equation 3.4.

**Equation 3.4 Permeable Pavement Storage Volume**

$$S_v = (d_p \times \eta_r \times A_p) + \left(\frac{i \times t_f}{2}\right)$$

where:

- $S_v$  = storage volume (ft<sup>3</sup>)
- $d_p$  = depth of the reservoir layer (or depth of the infiltration sump for enhanced designs with underdrains) (ft)
- $\eta_r$  = effective porosity for the reservoir layer (0.35)
- $A_p$  = permeable pavement surface area (ft<sup>2</sup>)



- $i$  = field-verified infiltration rate for the subgrade soils (ft/day). If an impermeable liner is used in the design then  $i = 0$ .
- $t_f$  = time to fill the reservoir layer (day) (assume 2 hours or 0.083 day)

**Detention Storage Design.** Permeable pavement can also be designed to address, in whole or in part, the detention storage needed to comply with channel protection and/or flood control requirements. The designer can model various approaches by factoring in storage within the stone aggregate layer (including chamber structures that increase the available storage volume), expected infiltration, and any outlet structures used as part of the design. Routing calculations can also be used to provide a more accurate solution of the peak discharge and required storage volume.

Once runoff passes through the surface of the permeable pavement system, designers should calculate outflow pathways to handle subsurface flows. Subsurface flows can be regulated using underdrains, the volume of storage in the reservoir layer, the bed slope of the reservoir layer, and/or a control structure at the outlet (see Section 3.5.2 Permeable Pavement Conveyance Criteria).

### 3.5.5 Permeable Pavement Landscaping Criteria

Permeable pavement does not have any landscaping needs associated with it. However, large-scale permeable pavement applications should be carefully planned to integrate the typical landscaping features of a parking lot, such as trees and islands, in a manner that maximizes runoff treatment and minimizes the risk that sediment, mulch, grass clippings, leaves, nuts, and fruits will inadvertently clog the paving surface. Bioretention areas (see Section 3.6 Bioretention) may be a good design option to meet these needs.

### 3.5.6 Permeable Pavement Construction Sequence

Experience has shown that proper installation is absolutely critical to the effective operation of a permeable pavement system.

**Erosion and Sediment Controls.** The following erosion and sediment control guidelines must be followed during construction:

- All permeable pavement areas should be fully protected from sediment intrusion by silt fence or construction fencing, particularly if they are intended to infiltrate runoff.
- Permeable pavement areas intended to infiltrate runoff must remain outside the limit of disturbance during construction to prevent soil compaction by heavy equipment (unless the area has been determined to have a low CBR and will require compaction during the permeable pavement construction phase). Where this is infeasible, the impacted area cannot be excavated below 2 feet above the final design elevation of the bottom of the aggregate reservoir course until further compaction by heavy equipment can be avoided. Once the area is excavated to grade, the impacted area must be tilled to a depth of 12 inches below the bottom of the reservoir layer. If these excavation/compaction limitations cannot be met, infiltration tests will be required prior to installation of the permeable pavement to ensure

that the design infiltration rate is still present. Permeable pavement areas must be clearly marked on all construction documents and grading plans.

- During construction, care should be taken to avoid tracking sediments onto any permeable pavement surface to avoid clogging.
- Any area of the site intended ultimately to be a permeable pavement area should generally not be used as the site of a temporary sediment basin. Where locating a sediment basin on an area intended for permeable pavement is unavoidable, the invert of the sediment basin must be a minimum of 1 foot above the final design elevation of the bottom of the aggregate reservoir course. All sediment deposits in the excavated area should be carefully removed prior to installing the sub-base, base, and surface materials. The plan must also show the proper procedures for converting the temporary sediment control practice to a permeable pavement BMP, including dewatering, cleanout, and stabilization.

**Permeable Pavement Installation.** The following is a typical construction sequence to properly install permeable pavement, which may need to be modified depending on the specific variant of permeable pavement that is being installed.

**Step 1:** Construction of the permeable pavement should only begin after the entire contributing drainage area has been stabilized. The proposed site should be checked for existing utilities prior to any excavation. Do not install the system in rain or snow and do not install frozen bedding materials.

**Step 2:** As noted above, temporary erosion and sediment controls are needed during installation to divert stormwater away from the permeable pavement area until it is completed. Special protection measures, such as erosion control fabrics, may be needed to protect vulnerable side slopes from erosion during the excavation process. The proposed permeable pavement area must be kept free from sediment during the entire construction process. Construction materials contaminated by sediments must be removed and replaced with clean materials.

**Step 3:** Where possible, excavators or backhoes should work from the sides to excavate the reservoir layer to its appropriate design depth and dimensions. For small pavement applications, excavating equipment should have arms with adequate extension so they do not have to work inside the footprint of the permeable pavement area (to avoid compaction). Contractors can utilize a cell construction approach, whereby the proposed permeable pavement area is split into 500-to 1,000-square foot temporary cells with a 10- to 15-foot earth bridge in between, so cells can be excavated from the side. Excavated material should be placed away from the open excavation so as to not jeopardize the stability of the side walls.

**Step 4:** The native soils along the bottom of the permeable pavement system should be scarified or tilled to a depth of 3 to 4 inches prior to the placement of the filter layer or geotextile fabric. In large scale paving applications with weak soils, the soil subgrade may need to be compacted to 95 percent of the Standard Proctor Density to achieve the desired load-bearing capacity. Note: This may reduce or eliminate the infiltration function of the installation, and it must be addressed during hydrologic design.

**Step 5:** Geotextile fabric should be installed on the sides of the reservoir layer (and the bottom if the design calls for it). Geotextile fabric strips should overlap down-slope by a minimum of 2 feet and be secured a minimum of 4 feet beyond the edge of the excavation.

Where the filter layer extends beyond the edge of the pavement (to convey runoff to the reservoir layer), install an additional layer of geotextile fabric 1 foot below the surface to prevent sediments from entering into the reservoir layer. Excess geotextile fabric should not be trimmed until the site is fully stabilized.

**Step 6:** Provide a minimum of 2 inches of aggregate above and below the underdrains. The up-gradient end of underdrains in the reservoir layer should be capped. Where an underdrain pipe is connected to a structure, there shall be no perforations within 1 foot of the structure. Ensure there are no perforations in clean-outs and observation wells within 1 foot of the surface.

**Step 7:** Spread 6-inch lifts of the appropriate clean, washed stone aggregate (usually No. 2 or No. 57 stone). Place at least 4 inches of additional aggregate above the underdrain, and then compact it using a vibratory roller in static mode until there is no visible movement of the aggregate. Do not crush the aggregate with the roller.

**Step 8:** Install the desired depth of the bedding layer, depending on the type of pavement, as indicated in Table 3.14.

**Step 9:** Paving materials shall be installed in accordance with manufacturer or industry specifications for the particular type of pavement.

**Installation of Porous Asphalt.** The following has been excerpted from various documents, most notably Jackson (2007):

- Install porous asphalt pavement similarly to regular asphalt pavement. The pavement should be laid in a single lift over the filter course. The laying temperature should be between 230oF and 260oF, with a minimum air temperature of 50oF, to ensure the surface does not stiffen before compaction.
- Complete compaction of the surface course when the surface is cool enough to resist a 10-ton roller. One or two passes of the roller are required for proper compaction. More rolling could cause a reduction in the porosity of the pavement.
- The mixing plant must provide certification of the aggregate mix, abrasion loss factor, and asphalt content in the mix. Test the asphalt mix for its resistance to stripping by water using ASTM 1664. If the estimated coating area is not above 95 percent, additional anti-stripping agents must be added to the mix.
- Transport the mix to the site in a clean vehicle with smooth dump beds sprayed with a non-petroleum release agent. The mix shall be covered during transportation to control cooling.
- Test the full permeability of the pavement surface by application of clean water at a rate of at least five gallons per minute over the entire surface. All water must infiltrate directly, without puddle formation or surface runoff.
- Inspect the facility 18 to 30 hours after a significant rainfall (greater than 1/2 inch) or artificial flooding to determine the facility is draining properly.

**Installation of Pervious Concrete.** The basic installation sequence for pervious concrete is outlined by the American Concrete Institute (2008). It is strongly recommended that concrete installers successfully complete a recognized pervious concrete installers training program, such

as the Pervious Concrete Contractor Certification Program offered by the NRMCA. The basic installation procedure is as follows:

- Drive the concrete truck as close to the project site as possible.
- Water the underlying aggregate (reservoir layer) before the concrete is placed, so the aggregate does not draw moisture from the freshly laid pervious concrete.
- After the concrete is placed, approximately 3/8 to 1/2 inch is struck off, using a vibratory screed. This is to allow for compaction of the concrete pavement.
- Compact the pavement with a steel pipe roller. Care should be taken to ensure over-compaction does not occur.
- Cut joints for the concrete to a depth of 1/4 inch.
- The curing process is very important for pervious concrete. Concrete installers should follow manufacturer specifications to the extent allowed by on-site conditions when curing pervious concrete.
- Remove the plastic sheeting only after the proper curing time. Inspect the facility 18 to 30 hours after a significant rainfall (greater than 1/2 inch) or artificial flooding, to determine the facility is draining properly.

**Installation of Permeable Interlocking Concrete Pavers.** The basic installation process is described in greater detail by Smith (2006):

- Place edge restraints for open-jointed pavement blocks before the bedding layer and pavement blocks are installed. Permeable interlocking concrete pavement (IP) systems require edge restraints to prevent vehicle loads from moving the paver blocks. Edge restraints may be standard curbs or gutter pans, or precast or cast-in-place reinforced concrete borders a minimum of 6 inches wide and 18 inches deep, constructed with Class A3 concrete. Edge restraints along the traffic side of a permeable pavement block system are recommended.
- Place the No. 57 stone in a single lift. Level the filter course and compact it into the reservoir course beneath with at least four passes of a 10-ton steel drum static roller until there is no visible movement. The first 2 passes are in vibratory mode, with the final 2 passes in static mode. The filter aggregate should be moist to facilitate movement into the reservoir course.
- Place and screed the bedding course material (typically No. 8 stone).
- Fill gaps at the edge of the paved areas with cut pavers or edge units. When cut pavers are needed, cut the pavers with a paver splitter or masonry saw. Cut pavers no smaller than 1/3 of the full unit size.
- Pavers may be placed by hand or with mechanical installers. Fill the joints and openings with stone. Joint openings must be filled with ASTM D 448 No. 8 stone; although, No. 8P or No. 9 stone may be used where needed to fill narrower joints. Remove excess stones from the paver surface.
- Compact and seat the pavers into the bedding course with a minimum low-amplitude 5,000-lbf, 75- to 95-Hz plate compactor.
- Do not compact within 6 feet of the unrestrained edges of the pavers.

- The system must be thoroughly swept by a mechanical sweeper or vacuumed immediately after construction to remove any sediment or excess aggregate.
- Inspect the area for settlement. Any blocks that settle must be reset and re-inspected.
- Inspect the facility 18 to 30 hours after a significant rainfall (1/2 inch or greater) or artificial flooding to determine whether the facility is draining properly.

**Construction Supervision.** Supervision before, during, and after construction by a qualified professional is recommended to ensure permeable pavement is built in accordance with these specifications. Inspection checklists that require sign-offs by qualified individuals should be used at critical stages of construction, to ensure the contractor's interpretation of the plan is consistent with the designer's intent.

DDOE's construction phase inspection checklist for permeable pavement practices can be found in Appendix L.

Some common pitfalls can be avoided by careful construction supervision that focuses on the following key aspects of permeable pavement installation:

- Store materials in a protected area to keep them free from mud, dirt, and other foreign materials.
- The contributing drainage area should be stabilized prior to directing water to the permeable pavement area.
- Check the aggregate material to confirm it is clean and washed, meets specifications and is installed to the correct depth. Aggregate loads that do not meet the specifications or do not appear to be sufficiently washed may be rejected.
- Check elevations (e.g., the invert of the underdrain, inverts for the inflow and outflow points, etc.) and the surface slope.
- Make sure the permeable pavement surface is even, runoff evenly spreads across it, and the storage bed drains within 48 hours.
- Ensure caps are placed on the upstream (but not the downstream) ends of the underdrains.
- Inspect the pretreatment structures (if applicable) to make sure they are properly installed and working effectively.
- Once the final construction inspection has been completed, log the GPS coordinates for each facility and submit them for entry into the BMP maintenance tracking database.

It may be advisable to divert the runoff from the first few runoff-producing storms away from larger permeable pavement applications, particularly when up-gradient conventional asphalt areas drain to the permeable pavement. This can help reduce the input of fine particles often produced shortly after conventional asphalt is laid down

### 3.5.7 Permeable Pavement Maintenance Criteria

Maintenance is a required and crucial element to ensure the long-term performance of permeable pavement. The most frequently cited maintenance problem is surface clogging caused by organic matter and sediment. Periodic street sweeping will remove accumulated sediment and help prevent clogging; however, it is also critical to ensure that surrounding land areas remain stabilized.

The following tasks must be avoided on ALL permeable pavements:

- Sanding
- Re-sealing
- Re-surfacing
- Power washing
- Storage of snow piles containing sand
- Storage of mulch or soil materials
- Construction staging on unprotected pavement

It is difficult to prescribe the specific types or frequency of maintenance tasks that are needed to maintain the hydrologic function of permeable pavement systems over time. The frequency of maintenance will depend largely on the pavement use, traffic loads, and the surrounding land use.

One preventative maintenance task for large-scale applications involves vacuum sweeping on a frequency consistent with the use and loadings encountered in the parking lot. Many consider an annual, dry-weather sweeping in the spring months to be important. The contract for sweeping should specify that a vacuum sweeper be used that does not use water spray, since spraying may lead to subsurface clogging. Typical maintenance tasks are outlined in Table 3.15.

**Table 3.15 Typical Maintenance Tasks for Permeable Pavement Practices**

Frequency <sup>1</sup>	Maintenance Tasks
After installation	<ul style="list-style-type: none"> <li>▪ For the first 6 months following construction, the practice and CDA should be inspected at least twice after storm events that exceed 1/2 inch of rainfall. Conduct any needed repairs or stabilization.</li> </ul>
Once every 1–2 months during the growing season	<ul style="list-style-type: none"> <li>▪ Mow grass in grid paver applications</li> </ul>
As needed	<ul style="list-style-type: none"> <li>▪ Stabilize the contributing drainage area to prevent erosion</li> <li>▪ Remove any soil or sediment deposited on pavement.</li> <li>▪ Replace or repair any necessary pavement surface areas that are degenerating or spalling</li> </ul>
2–4 times per year	<ul style="list-style-type: none"> <li>▪ Vacuum pavement with a standard street sweeper to prevent clogging</li> </ul>

Frequency <sup>1</sup>	Maintenance Tasks
(depending on use)	
Annually	<ul style="list-style-type: none"> <li>▪ Conduct a maintenance inspection</li> <li>▪ Spot weeding of grass applications</li> </ul>
Once every 2–3 years	<ul style="list-style-type: none"> <li>▪ Remove any accumulated sediment in pre-treatment cells and inflow points</li> </ul>
If clogged	<ul style="list-style-type: none"> <li>▪ Conduct maintenance using a regenerative street sweeper</li> <li>▪ Replace any necessary joint material</li> </ul>

**Winter Maintenance Considerations:** Winter maintenance for permeable pavements is similar to standard pavements, with a few additional considerations:

- Large snow storage piles should be located in adjacent grassy areas so that sediments and pollutants in snowmelt are partially treated before they reach the permeable pavement.
- Sand or cinders should never be applied for winter traction over permeable pavement or areas of standard (impervious) pavement that drain toward permeable pavement, since it will quickly clog the system.
- When plowing plastic reinforced grid pavements, snow plow blades should be lifted 1/2 inch to 1 inch above the pavement surface to prevent damage to the paving blocks or turf. Porous asphalt (PA), pervious concrete (PC), and some permeable pavers (PP) can be plowed similar to traditional pavements, using similar equipment and settings.
- Owners should be judicious when using chloride products for deicing over all permeable pavements designed for infiltration, since the salts will be transmitted through the pavement. Salt can be applied but environmentally sensitive deicers are recommended. Permeable pavement applications will generally require less salt application than traditional pavements.

When permeable pavements are installed on private residential lots, homeowners will need to (1) be educated about their routine maintenance needs and (2) understand the long-term maintenance plan.

It is recommended that a qualified professional conduct a spring maintenance inspection and cleanup at each permeable pavement site, particularly at large-scale applications. DDOE’s maintenance inspection checklists for permeable pavements can be found in Appendix M.

**Declaration of Covenants.** A declaration of covenants that includes all maintenance responsibilities to ensure the continued stormwater performance for the BMP is required. The declaration of covenants specifies the property owner’s primary maintenance responsibilities, and authorizes DDOE staff to access the property for inspection or corrective action in the event the proper maintenance is not performed. The declaration of covenants is attached to the deed of the property. An example form is provided at the end of Chapter 5 though variations will exist for scenarios where stormwater crosses property lines. The covenant is between the property and the District Government. It is submitted through the Office of the Attorney General (OAG). All SWMPs have a maintenance agreement stamp that must be signed for a building permit to

proceed. A maintenance schedule must appear on the SWMP. Additionally, a maintenance schedule is required in schedule c of the declaration of covenants.

Covenants are not required on government properties, but maintenance responsibilities must be defined through a partnership agreement or a memorandum of understanding.

**Waste Material.** Waste material from the repair, maintenance, or removal of a BMP or land cover shall be removed and disposed of in compliance with applicable federal and District law.

### 3.5.8 Permeable Pavement Stormwater Compliance Calculations

Permeable pavement retention value varies depending on the design configuration of the system.

**Enhanced Designs.** These permeable pavement applications have an infiltration sump and water-quality filter, but no underdrain. Enhanced designs receive 100 percent retention value for the amount of storage volume (Sv) provided by the practice (Table 3.16). Since the practice gets 100 percent retention value, it is not considered an accepted TSS treatment practice.

**Table 3.16 Enhanced Permeable Pavement Retention Value and Pollutant Removal**

Retention Value	= Sv
Accepted TSS Treatment Practice	N/A

Note: If using an infiltration sump design, only the volume stored in the sump can be counted as the Enhanced Design Storage Volume (Sv). Any volume stored in the practice above the sump is counted as a standard design. When using the Site Design Spreadsheet, the Sv of the infiltration sump should be entered into the cell ‘Storage Volume Provided by the Practice’ in the Permeable Pavement – Enhanced row. Permeable Pavement – Standard should then be selected as the downstream practice. Next, in the Permeable Pavement - Standard row, the Sv provided above the infiltration sump should be entered into the cell ‘Storage Volume Provided by the Practice,’ and the surface area of the pavement should be entered in the ‘Area of Practice’ cell.

**Standard Designs.** These permeable pavement applications have an underdrain, but no infiltration sump or water quality filter. Standard designs receive a retention value of 4.5 cubic feet per 100 square feet of practice area and are an accepted TSS removal practice for the amount of storage volume (Sv) provided by the practice (Table 3.17).

**Table 3.17 Standard Permeable Pavement Retention Value and Pollutant Removal**

Retention Value	= Sv
Accepted TSS Treatment Practice	N/A

The practice must be sized using the guidance detailed in Section 3.5.4.



Permeable pavement also contributes to peak flow reduction. This contribution can be determined in several ways. One method is to subtract the retention value achieved by the practice from the total runoff volume for the 2-year, 15-year, and 100-year storms. The resulting reduced runoff volumes can then be used to calculate a Reduced Natural Resource Conservation Service (NRCS) Curve Number for the site or drainage area. The Reduced Curve Number can then be used to calculate peak flow rates for the various storm events. Other hydrologic modeling tools that employ different procedures may be used as well.

### 3.5.9 References

- Brown, R. and W. Hunt. 2009. "Improving Exfiltration from BMPs: Research and Recommendations." North Carolina Cooperative Extension Service Bulletin. Urban Waterways Series.
- Hunt, W. and K. Collins. 2008. "Permeable Pavement: Research Update and Design Implications." North Carolina Cooperative Extension Service Bulletin. Urban Waterways Series.
- Jackson, N. 2007. Design, Construction and Maintenance Guide for Porous Asphalt Pavements. National Asphalt Pavement Association (NAPA), Porous Asphalt Pavements for Stormwater Management: Design, Construction, and Maintenance Guide (IS-131). Lanham, MD, 2008. <http://store.asphalt pavement.org/index.php?productID=179>
- Smith, D. 2006. Permeable Interlocking Concrete Pavement-selection design, construction and maintenance. Third Edition. Interlocking Concrete Pavement Institute. Herndon, VA.
- Virginia DCR Stormwater Design Specification No. 7: Permeable Pavement Version 1.7. 2010.

### 3.6 Bioretention

Definition. Practices that capture and store stormwater runoff and pass it through a filter bed of engineered soil media comprised of sand, soil, and organic matter. Filtered runoff may be collected and returned to the conveyance system, or allowed to infiltrate into the soil. Design variants include:

- B-1 Traditional bioretention
- B-2 Streetscape bioretention
- B-3 Engineered tree pits
- B-4 Stormwater planters
- B-5 Residential rain gardens

Bioretention systems are typically not to be designed to provide stormwater detention of larger storms (e.g., 2-year, 15-year), but they may be in some circumstances. Bioretention practices shall generally be combined with a separate facility to provide those controls.

There are two different types of bioretention design configurations:

- **Standard Designs.** Practices with a standard underdrain design and less than 24 inches of filter media depth (see Figure 3.17). If trees are planted using this design, the filter media depth must be at least 24" to support the trees.
- **Enhanced Designs.** Practices that can infiltrate the design storm volume in 72 hours (see Figure 3.19) or practices with underdrains that contain at least 24 inches of filter media depth and an infiltration sump/storage layer (see Figure 3.18).

The particular design configuration to be implemented on a site is typically dependent on specific site conditions and the characteristics of the underlying soils. These criteria are further discussed below.

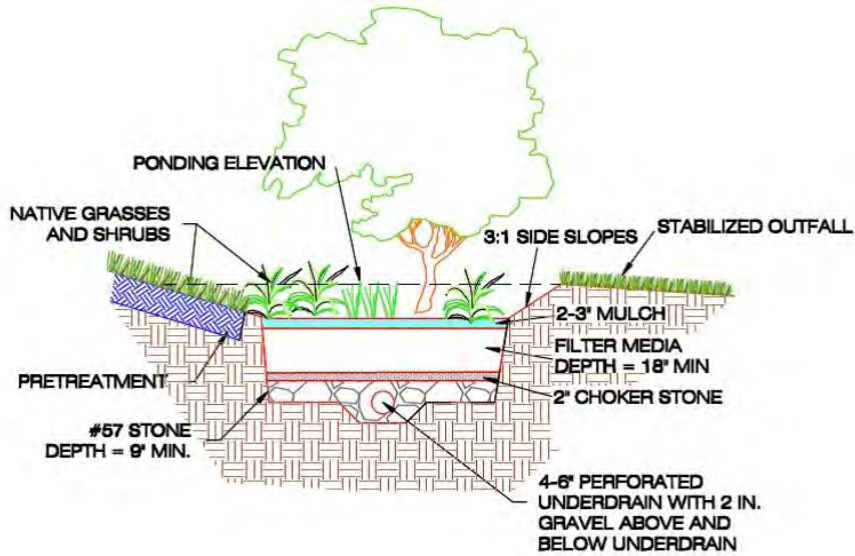
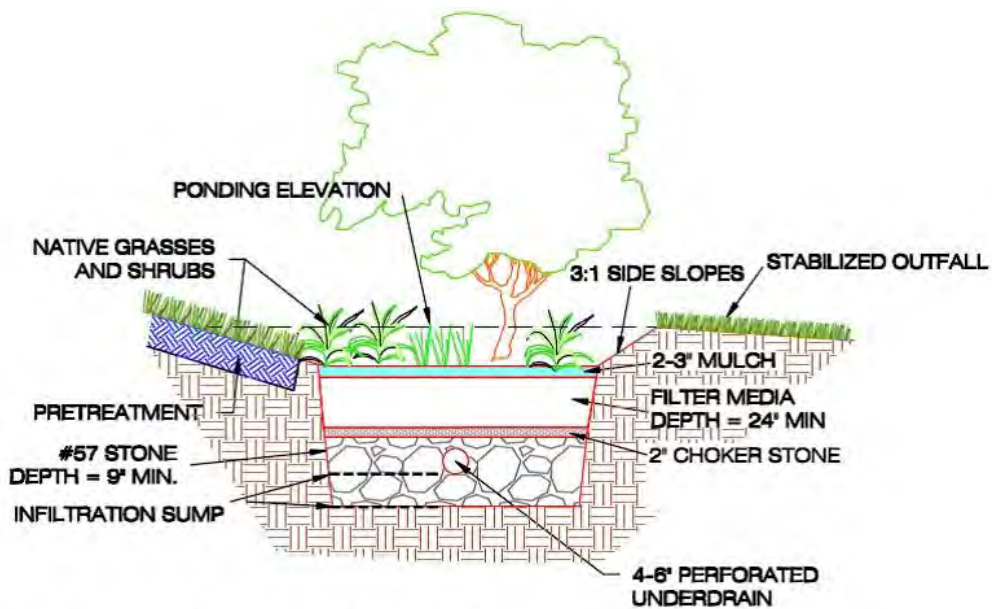


Figure 3.17 Example of standard bioretention design.



NOTE: If underlying soil infiltration rate  $< 0.5$ "/hr, the underdrain and infiltration sump option may be used. The infiltration sump option must be designed to infiltrate the design storm volume in less than 72 hours.

Figure 3.18 Example of an enhanced bioretention design with an underdrain and infiltration sump/storage layer.

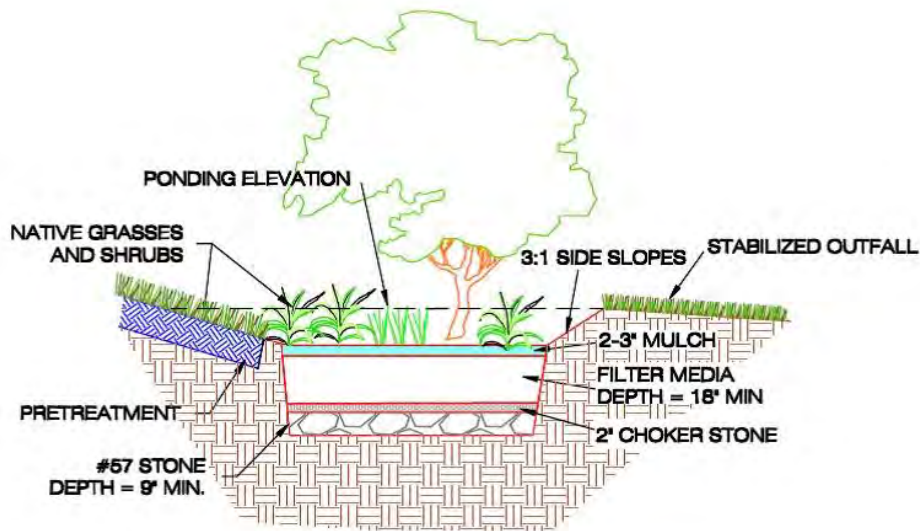


Figure 3.19 Example of enhanced bioretention design without an underdrain.

### 3.6.1 Bioretention Feasibility Criteria

Bioretention can be applied in most soils or topography, since runoff simply percolates through an engineered soil bed and is infiltrated or returned to the stormwater system via an underdrain. Key constraints with bioretention include the following:

**Required Space.** Planners and designers can assess the feasibility of using bioretention facilities based on a simple relationship between the contributing drainage area and the corresponding bioretention surface area. The surface area is recommended to be approximately 3 to 6 percent of the contributing drainage area (CDA), depending on the imperviousness of the CDA and the desired bioretention ponding depth.

**Available Hydraulic Head.** Bioretention is fundamentally constrained by the invert elevation of the existing conveyance system to which the practice discharges (i.e., the bottom elevation needed to tie the underdrain from the bioretention area into the storm drain system). In general, 4 to 5 feet of elevation above this invert is needed to accommodate the required ponding and filter media depths. If the practice does not include an underdrain or if an inverted or elevated underdrain design is used, less hydraulic head may be adequate.

**Water Table.** Bioretention must be separated from the water table to ensure that groundwater does not intersect the filter bed. Mixing can lead to possible groundwater contamination or failure of the bioretention facility. A separation distance of 2 feet is required between the bottom of the excavated bioretention area and the seasonally high ground water table.

**Soils and Underdrains.** Soil conditions do not typically constrain the use of bioretention; although, they do determine whether an underdrain is needed. Underdrains may be required if the measured permeability of the underlying soils is less than 0.5 in./hr. When designing a

bioretention practice, designers must verify soil permeability by using the on-site soil investigation methods provided in Appendix P. Impermeable soils will require an underdrain.

In fill soil locations, geotechnical investigations are required to determine if the use of an impermeable liner and underdrain are necessary.

**Contributing Drainage Area.** Bioretention cells work best with smaller contributing drainage areas, where it is easier to achieve flow distribution over the filter bed. The maximum drainage area to a traditional bioretention area (B-1) is 2.5 acres and can consist of up to 100 percent impervious cover. The drainage area for smaller bioretention practices (B-2, B-3, B-4, and B-5) is a maximum of 1 acre. However, if hydraulic considerations are adequately addressed to manage the potentially large peak inflow of larger drainage areas, such as off-line or low-flow diversions, or forebays, there may be case-by-case instances where the maximum drainage areas can be adjusted. Table 3.18 summarizes typical recommendations for bioretention contributing drainage areas.

**Table 3.18 Maximum Contributing Drainage Area to Bioretention**

Bioretention Type	Design Variants	Maximum Contributing Drainage Area (acres of impervious cover)
Traditional	B-1	2.5
Small-scale and Urban Bioretention	B-2, B-3, B-4, and B-5	1.0

**Hotspot Land Uses.** An impermeable bottom liner and an underdrain system must be employed when a bioretention area will receive untreated hotspot runoff, and the Enhanced Design configuration cannot be used. However, bioretention can still be used to treat —non-hotspot” parts of the site; for instance, roof runoff can go to bioretention while vehicular maintenance areas would be treated by a more appropriate hotspot practice.

For a list of potential stormwater hotspots, please consult Appendix Q.

On sites with existing contaminated soils, as indicated in Appendix Q, infiltration is not allowed. Bioretention areas must include an impermeable liner, and the Enhanced Design configuration cannot be used.

**No Irrigation or Baseflow.** The planned bioretention area should not receive baseflow, irrigation water, chlorinated wash-water or other such non-stormwater flows. However, irrigation is allowed during the establishment period of the bioretention area to ensure plant survival.

**Setbacks.** To avoid the risk of seepage, bioretention areas must not be hydraulically connected to structure foundations. Setbacks to structures must be at least 10 feet and adequate water-proofing protection must be provided for foundations and basements. Where the 10-foot setback is not possible, an impermeable liner may be used along the sides of the bioretention area (extending from the surface to the bottom of the practice).

**Proximity to Utilities.** Designers should ensure that future tree canopy growth in the bioretention area will not interfere with existing overhead utility lines. Interference with underground utilities should be avoided, if possible. When large site development is undertaken the expectation of achieving avoidance will be high. Conflicts may be commonplace on smaller sites and in the public right-of-way. Consult with each utility company on recommended offsets, which will allow utility maintenance work with minimal disturbance to the bioretention system. For bioretention in the public right-of-way a consolidated presentation of the various utility offset recommendations can be found in Chapter 33.14.5 of the District of Columbia Department of Transportation Design and Engineering Manual, latest edition. Consult the District of Columbia Water and Sewer Authority Green Infrastructure Utility Protection Guidelines, latest edition, for water and sewer line recommendations. Where conflicts cannot be avoided, follow these guidelines:

- Consider altering the location or sizing of the bioretention to avoid or minimize the utility conflict. Consider an alternate BMP type to avoid conflict.
- Use design features to mitigate the impacts of conflicts that may arise by allowing the bioretention and the utility to co-exist. The bioretention design may need to incorporate impervious areas, through geotextiles or compaction, to protect utility crossings. Other a key design feature may need to be moved or added or deleted
- Work with the utility to evaluate the relocation of the existing utility and install the optimum placement and sizing of the bioretention.
- If utility functionality, longevity and vehicular access to manholes can be assured accept the bioretention design and location with the existing utility. Incorporate into the bioretention design sufficient soil coverage over the utility or general clearances or other features such as an impermeable linear to assure all entities the conflict is limited to maintenance.

Note: When accepting utility conflict into the bioretention location and design, it is understood the bioretention will be temporarily impacted during utility work but the utility will replace the bioretention or, alternatively, install a functionally comparable bioretention according to the specifications in the current version of this Stormwater Management Guidebook. If the bioretention is located in the public right-of-way the bioretention restoration will also conform with the District of Columbia Department of Transportation Design and Engineering Manual with special attention to Chapter 33, Chapter 47 and the Design and Engineering Manual supplements for Low Impact Development and Green Infrastructure Standards and Specifications.

**Minimizing External Impacts.** Urban bioretention practices may be subject to higher public visibility, greater trash loads, pedestrian traffic, vandalism, and even vehicular loads. Designers should design these practices in ways that prevent, or at least minimize, such impacts. In addition, designers should clearly recognize the need to perform frequent landscaping maintenance to remove trash, check for clogging, and maintain vigorous vegetation. The urban landscape context may feature naturalized landscaping or a more formal design. When urban bioretention is used in sidewalk areas of high foot traffic, designers should not impede pedestrian movement or create a safety hazard. Designers may also install low fences, grates, or other measures to prevent damage from pedestrian short-cutting across the practices.

When bioretention will be included in public rights-of-way or spaces, design manuals and guidance developed by the District Department of Transportation, Office of Planning, National Capital Planning Commission, and other agencies or organizations may also apply (in addition to DDOE).

### 3.6.2 Bioretention Conveyance Criteria

There are two basic design approaches for conveying runoff into, through, and around bioretention practices:

1. Off-line: Flow is split or diverted so that only the design storm or design flow enters the bioretention area. Larger flows by-pass the bioretention treatment.
2. On-line: All runoff from the drainage area flows into the practice. Flows that exceed the design capacity exit the practice via an overflow structure or weir.

If runoff is delivered by a storm drain pipe or is along the main conveyance system, the bioretention area shall be designed off-line so that flows do not overwhelm or damage the practice.

**Off-line bioretention.** Overflows are diverted from entering the bioretention cell. Optional diversion methods include the following:

- Create an alternate flow path at the inflow point into the structure such that when the maximum ponding depth is reached, the incoming flow is diverted past the facility. In this case, the higher flows do not pass over the filter bed and through the facility, and additional flow is able to enter as the ponding water filters through the soil media. With this design configuration, an overflow structure in the bioretention area is not required.
- Utilize a low-flow diversion or flow splitter at the inlet to allow only the design storm volume (i.e., the Stormwater Retention Volume (SWRV)) to enter the facility (calculations must be made to determine the peak flow from 1.2", 24-hour storm). This may be achieved with a weir, curb opening, or orifice for the target flow, in combination with a bypass channel or pipe. Using a weir or curb opening helps minimize clogging and reduces the maintenance frequency. With this design configuration, an overflow structure in the bioretention area is required (see on-line bioretention below).

**On-line bioretention.** An overflow structure must be incorporated into on-line designs to safely convey larger storms through the bioretention area. The following criteria apply to overflow structures:

- An overflow shall be provided within the practice to pass storms greater than the design storm storage to a stabilized water course. A portion of larger events may be managed by the bioretention area so long as the maximum depth of ponding in the bioretention cell does not exceed 18 inches.
- The overflow device must convey runoff to a storm sewer, stream, or the existing stormwater conveyance infrastructure, such as curb and gutter or an existing channel.

- Common overflow systems within bioretention practices consist of an inlet structure, where the top of the structure is placed at the maximum ponding depth of the bioretention area, which is typically 6 to 18 inches above the surface of the filter bed.
- The overflow device should be scaled to the application. This may be a landscape grate or yard inlet for small practices or a commercial-type structure for larger installations.
- At least 3–6 inches of freeboard must be provided between the top of the overflow device and the top of the bioretention area to ensure that nuisance flooding will not occur.
- The overflow associated with the 2-year and 15-year design storms must be controlled so that velocities are non-erosive at the outlet point (i.e., to prevent downstream erosion).

### 3.6.3 Bioretention Pretreatment Criteria

Pretreatment of runoff entering bioretention areas is necessary to trap coarse sediment particles before they reach and prematurely clog the filter bed. Pretreatment measures must be designed to evenly spread runoff across the entire width of the bioretention area. Several pretreatment measures are feasible, depending on the type of the bioretention practice and whether it receives sheet flow, shallow concentrated flow, or deeper concentrated flows. The following are appropriate pretreatment options:

#### Small-Scale Bioretention (B-2, B-3, B-4, and B-5)

- **Leaf Screens** as part of the gutter system serve to keep the heavy loading of organic debris from accumulating in the bioretention cell.
- **Grass Filter Strips** (for sheet flow), applied on residential lots, where the lawn area can serve as a grass filter strip adjacent to a rain garden.
- **Stone Diaphragm** (for either sheet flow or concentrated flow); this is a stone diaphragm at the end of a downspout or other concentrated inflow point that should run perpendicular to the flow path to promote settling. Note: stone diaphragms are not recommended for school settings.
- **Trash Racks** (for either sheet flow or concentrated flow) between the pretreatment cell and the main filter bed or across curb cuts. These will allow trash to collect in specific locations and create easier maintenance.
- **Pretreatment Cells** (see below) located above ground or covered by a manhole or grate. This type of pretreatment is not recommended for residential rain gardens (B-5).

#### Traditional Bioretention

- **Pretreatment Cells (channel flow)**. Similar to a forebay, this cell is located at piped inlets or curb cuts leading to the bioretention area and consists of an energy dissipater sized for the expected rates of discharge. It has a storage volume equivalent to at least 15 percent of the total storage volume (inclusive) with a recommended 2:1 length-to-width ratio. The cell may be formed by a wooden or stone check dam or an earthen or rock berm. Pretreatment cells do not need underlying engineered soil media, in contrast to the main bioretention cell. However, if the volume of the pretreatment cell will be included as part of the bioretention



storage volume, the pretreatment cell must de-water between storm events. It cannot have a permanent ponded volume.

- **Grass Filter Strips (sheet flow).** Grass filter strips that are perpendicular to incoming sheet flow extend from the edge of pavement (i.e., with a slight drop at the pavement edge) to the bottom of the bioretention basin at a 5:1 slope or flatter. Alternatively, if the bioretention basin has side slopes that are 3:1 or flatter, a 5 foot grass filter strip at a maximum 5 percent (20:1) slope can be used.
- **Stone Diaphragms (sheet flow).** A stone diaphragm located at the edge of the pavement should be oriented perpendicular to the flow path to pretreat lateral runoff, with a 2 to 4 inch drop from the pavement edge to the top of the stone. The stone must be sized according to the expected rate of discharge.
- **Gravel or Stone Flow Spreaders (concentrated flow).** The gravel flow spreader is located at curb cuts, downspouts, or other concentrated inflow points, and should have a 2 to 4 inch elevation drop from a hard-edged surface into a gravel or stone diaphragm. The gravel must extend the entire width of the opening and create a level stone weir at the bottom or treatment elevation of the basin.
- **Filter System** (see Section 3.7 Stormwater Filtering Systems). If using a filter system as a pretreatment facility, the sand filter will not require its own separate pretreatment facility.
- **Innovative or Proprietary Structure.** An approved proprietary structure with demonstrated capability of reducing sediment and hydrocarbons may be used to provide pretreatment. Refer to Section 3.13 for information on approved proprietary structures.

Other pre-treatment options may be appropriate as long as they trap coarse sediment particles and evenly spread runoff across the entire width of the bioretention area.

### 3.6.4 Bioretention Design Criteria

**Design Geometry.** Bioretention basins must be designed with an internal flow path geometry such that the treatment mechanisms provided by the bioretention are not bypassed or short-circuited. In order for the bioretention area to have an acceptable internal geometry, the “travel time” from each inlet to the outlet should be maximized by locating the inlets and outlets as far apart as possible. In addition, incoming flow must be distributed as evenly as possible across the entire filter surface area.

**Inlets and Energy Dissipation.** Where appropriate, the inlet(s) to streetscape bioretention (B-2), engineered tree boxes (B-3), and stormwater planters (B-4) should be stabilized using No. 3 stone, splash block, river stone, or other acceptable energy dissipation measures. The following types of inlets are recommended:

- Downspouts to stone energy dissipaters.
- Sheet flow over a depressed curb with a 3-inch drop.
- Curb cuts allowing runoff into the bioretention area.
- Covered drains that convey flows across sidewalks from the curb or downspouts.
- Grates or trench drains that capture runoff from a sidewalk or plaza area.

- Drop structures that appropriately dissipate water energy.

**Ponding Depth.** The recommended surface ponding depth is 6–12 inches. Minimum surface ponding depth is 3 inches (averaged over the surface area of the BMP). Ponding depths can be increased to a maximum of 18 inches. However, when higher ponding depths are utilized, the design must consider carefully issues such as safety, fencing requirements, aesthetics, the viability and survival of plants, and erosion and scour of side slopes. This is especially true where bioretention areas are built next to sidewalks or other areas where pedestrians or bicyclists travel. Shallower ponding depths (i.e., typically 6 to 12 inches) are recommended for streetscape bioretention (B-2), engineered tree boxes (B-3), and stormwater planters (B-4).

**Side Slopes.** Traditional bioretention areas (B-1) and residential rain gardens (B-5) should be constructed with side slopes of 3:1 or flatter. In highly urbanized or space constrained areas, a drop curb design or a precast structure can be used to create a stable, vertical side wall. These drop curb designs should not exceed a vertical drop of more than 12 inches, unless safety precautions, such as railings, walls, grates, etc. are included.

**Filter Media.** The filter media and surface cover are the two most important elements of a bioretention facility in terms of long-term performance.

- **Particle Size Composition.** The bioretention soil mixture shall be classified as a loamy sand on the USDA Texture Triangle, with the following particle size composition:
  - ◆ 80–90 percent sand (at least 75 percent of which must be classified as coarse, or very coarse sand)
  - ◆ 10–20 percent soil fines (silt and clay)
  - ◆ Maximum 10 percent clay
  - ◆ The particle size analysis must be conducted on the mineral fraction only or following appropriate treatments to remove organic matter before particle size analysis.
- **Organic Matter.** The filter media must contain 3 to 5 percent organic matter by conventional Walkley-Black soil organic matter determination method or similar analysis. Soil organic matter is expressed on a dry weight basis and does not include coarse particulate (visible) components.
- **Available Soil Phosphorus (P).** The filter media should contain sufficient plant available P to support initial plant establishment and plant growth, but not serve as a significant source of P for long term leaching. Plant-available soil P should be within the range of Low+ (L+) to Medium (M) as defined in Table 2.2 of Virginia Nutrient Management Standards and Criteria (2005). For the Mehlich I extraction procedure this equates to a range of 5 to 15 mg/kg P or 18 to 40 mg/kg P for the Mehlich III procedure.
- **Cation Exchange Capacity (CEC).** The relative ability of soils to hold and retain nutrient cations like Ca and K is referred to as cation exchange capacity or CEC and is measured as the total amount of positively charged cations that a soil can hold per unit dry mass. CEC is also used as an index of overall soil reactivity and is commonly expressed in milliequivalents per 100 grams (meq/100g) of soil or cmol+/kg (equal values). A soil with a moderate to high CEC indicates a greater ability to capture and retain positively charged contaminants, which

encourages conditions to remove phosphorus, assuming that soil fines (particularly fine silts and clays) are at least partially responsible for CEC. The minimum CEC of the filter media is 5.0 (meq/100 g or cmol+/kg). The filter media CEC should be determined by the Unbuffered Salt, Ammonium Acetate, Summation of Cations or Effective CEC techniques (Sumner and Miller, 1996) or similar methods that do not utilize strongly acidic extracting solutions.

The goal of the mixture as described above is to create a soil media that maintains long-term permeability while also providing enough nutrients to support plant growth. The initial permeability of the mixture will exceed the desired long-term permeability of 1 to 2 in./hr. The limited amount of topsoil and organic matter is considered adequate to help support initial plant growth, and it is anticipated that the gradual increase of organic material through natural processes will continue to support growth while decreasing gradually the permeability. Finally, the root structure of maturing plants and the biological activity of a self-sustaining organic content will maintain sufficient long term permeability as well as support plant growth without the need for fertilizer inputs.

The following is the recommended composition of the three media ingredients:

- **Sand.** Sand shall consist of silica-based coarse aggregate, angular or round in shape and meet the mixture grain size distribution below. No substitutions of alternate materials such as diabase, calcium carbonate, rock dust or dolomitic sands are accepted. In particular, mica can make up no more than 5 percent of the total sand fraction. The sand fraction may also contain a limited amount of particles greater than 2.0 mm and less than 9.5 mm per the table below, but the overall sand fraction must meet the specification of greater than 75 percent being coarse or very coarse sand. Consult Table 3.19 for recommended sand sizing criteria.

**Table 3.19 Sand Sizing Criteria**

Sieve	Size (mm)	% Passing
3/8 in.	9.50	100
No. 4	4.75	95 to 100
No. 8	2.36	80 to 100
No. 16	1.18	45 to 85
No. 30	0.60	15 to 60
No. 50	0.30	3 to 15
No. 100	0.15	0 to 4

Note: Effective particle size (D10) > 0.3mm. Uniformity coefficient (D60/D10) < 4.0.

- **Topsoil.** Topsoil is generally defined as the combination of the other ingredients referenced in the bioretention filter media: sand, fines (silt and clay), and any associated soil organic matter. Since the objective of the specification is to carefully establish the proper blend of these ingredients, the designer (or contractor or materials supplier) must carefully select the topsoil source material in order to not exceed the amount of any one ingredient.

Generally, the use of a topsoil defined as a loamy sand, sandy loam, or loam (per the USDA Textural Triangle) will be an acceptable ingredient and in combination with the other ingredients meet the overall performance goal of the soil media.

- **Organic Matter.** Organic materials used in the soil media mix should consist of well-decomposed natural C-containing organic materials such as peat moss, humus, compost (consistent with the material specifications found in Appendix K), pine bark fines or other organic soil conditioning material. However, per above, the combined filter media should contain 3 to 5 percent soil organic matter on dry weight basis (grams organic matter per 100 grams dry soil) by the Walkley-Black method or other similar analytical technique.

In creating the filter media, it is recommended to start with an open-graded coarse sand material and proportionately mix in the topsoil materials to achieve the desired ratio of sand and fines. Sufficient suitable organic amendments can then be added to achieve the 3 to 5 percent soil organic matter target. The exact composition of organic matter and topsoil material will vary, making the exact particle size distribution of the final total soil media mixture difficult to define in advance of evaluating available materials. Table 3.20 summarizes the filter media requirements.

**Table 3.20 Filter Media Criteria for Bioretention**

Soil Media Criterion	Description	Standard(s)		
General Composition	Soil media must have the proper proportions of sand, fines, and organic matter to promote plant growth, drain at the proper rate, and filter pollutants	80% to 90% sand (75% of which is coarse or very coarse); 10% to 20% soil fines Max. 10% clay; and 3% to 5% organic matter		
Sand	Silica based coarse aggregate <sup>1</sup>	<b>Sieve</b>	<b>Size</b>	<b>% Passing</b>
		3/8 in	9.50 mm	100
		No. 4	4.75 mm	95 to 100
		No. 8	2.36 mm	80 to 100
		No. 16	1.18 mm	45 to 85
		No. 30	0.6 mm	15 to 60
		No. 50	0.3 mm	3 to 15
		No. 100	0.15 mm	0 to 4
		Effective Particle size (D10) > 0.3mm Uniformity Coefficient (D60/D10) < 4.0		
Top Soil	Loamy sand or Sandy Loam	USDA Textural Triangle		
Organic Matter	Well aged, clean compost	Appendix K		
P-Index or Phosphorus (P) content	Soil media with high P levels will export P through the media and potentially to downstream conveyances or receiving waters	P content = 5 to 15 mg/kg (Mehlich I) or 18 to 40 mg/kg (Mehlich III)		
Cation Exchange Capacity (CEC)	The CEC is determined by the amount of soil fines and organic matter. Higher CEC will promote pollutant removal	CEC > 5 milliequivalents per 100 grams		

<sup>1</sup>Many specifications for sand refer to ASTM C-33. The ASTM C-33 specification allows a particle size distribution that contains a large fraction of fines (silt and clay sized particles - < 0.05 mm). The smaller fines

fill the voids between the larger sand sized particles, resulting in smaller and more convoluted pore spaces. While this condition provides a high degree of treatment, it also encourages clogging of the remaining void spaces with suspended solids and biological growth, resulting in a greater chance of a restrictive biomat forming. By limiting the fine particles allowed in the sand component, the combined media recipe of sand and the fines associated with the soil and organic material will be less prone to clogging, while also providing an adequate level of filtration and retention.

In cases where greater removal of specific pollutants is desired, additives with documented pollutant removal benefits, such as water treatment residuals, alum, iron, or other materials may be included in the filter media if accepted by DDOE.

- **Filter Media Depth.** The filter media bed depth must be a minimum of 18 inches for the Standard Design. The media depth must be 24 inches or greater to qualify for the Enhanced Design, unless an infiltration-based design is used. The media depth must not exceed 6 feet. Turf, perennials, or shrubs should be used instead of trees to landscape shallower filter beds. See Table 3.23 and Table 3.24 for a list of recommended native plants.

During high intensity storm events, it is possible for the bioretention to fill up faster than the collected stormwater is able to filter through the soil media. This is dependent upon the surface area of the BMP (*SA*) relative to the contributing drainage area (*CDA*) and the runoff coefficient (*R<sub>v</sub>*) from the *CDA*. To ensure that the design runoff volume is captured and filtered appropriately, Table 3.21 indicates the maximum filter media depth (in feet) that can be utilized in a given bioretention area. The maximum filter media depth is based on the runoff coefficient of the *CDA* to the BMP (*R<sub>vCDA</sub>*) and the bioretention ratio of BMP surface area to the BMP *CDA* (*SA:CDA*) (in percent). The applicable filter media depth from Table 3.21 should be used as *d<sub>media</sub>* in Equation 3.5 below.

**Table 3.21 Determining Maximum Filter Media Depth (feet)**

SA:CDA (%)	R <sub>vCDA</sub>								
	0.25	0.3	0.40	0.50	0.60	0.70	0.80	0.90	0.95
0.5	6.0	6.0	6.0	6.0	6.0	6.0	6.0	6.0	6.0
1.0	5.0	5.5	6.0	6.0	6.0	6.0	6.0	6.0	6.0
1.5	3.5	4.0	5.0	6.0	6.0	6.0	6.0	6.0	6.0
2.0	2.5	3.0	4.0	5.0	5.5	6.0	6.0	6.0	6.0
2.5	2.0	2.5	3.5	4.0	4.5	5.0	5.5	6.0	6.0
3.0	1.5	2.0	3.0	3.5	4.0	4.5	5.0	5.5	5.5
3.5	1.5	1.5	2.5	3.0	3.5	4.0	4.5	5.0	5.0
4.0	1.5	1.5	2.0	2.5	3.0	3.5	4.0	4.5	4.5
4.5	1.5	1.5	2.0	2.5	3.0	3.5	3.5	4.0	4.5
5.0	1.5	1.5	1.5	2.0	2.5	3.0	3.5	4.0	4.0
5.5	1.5	1.5	1.5	2.0	2.5	2.5	3.0	3.5	3.5
6.0	1.5	1.5	1.5	1.5	2.0	2.5	3.0	3.0	3.5
6.5	1.5	1.5	1.5	1.5	2.0	2.5	2.5	3.0	3.0

SA:CDA (%)	R <sub>V</sub> CDA								
	0.25	0.3	0.40	0.50	0.60	0.70	0.80	0.90	0.95
7.0	1.5	1.5	1.5	1.5	1.5	2.0	2.5	3.0	3.0
7.5	1.5	1.5	1.5	1.5	1.5	2.0	2.5	2.5	2.5
8.0	1.5	1.5	1.5	1.5	1.5	2.0	2.0	2.5	2.5
8.5	1.5	1.5	1.5	1.5	1.5	1.5	2.0	2.0	2.5
9.0	1.5	1.5	1.5	1.5	1.5	1.5	2.0	2.0	2.0
9.5	1.5	1.5	1.5	1.5	1.5	1.5	1.5	2.0	2.0
10.0	1.5	1.5	1.5	1.5	1.5	1.5	1.5	2.0	2.0

**Surface Cover.** Mulch is the recommended surface cover material, but other materials may be substituted, as described below:

- **Mulch.** A 2- to 3-inch layer of mulch on the surface of the filter bed enhances plant survival, suppresses weed growth, pretreats runoff before it reaches the filter media, and prevents rapid evaporation of rainwater. Shredded hardwood bark mulch, aged for at least 6 months, makes a very good surface cover, as it retains a significant amount of pollutants and typically will not float away.
- **Alternative to Mulch Cover.** In some situations, designers may consider alternative surface covers, such as turf, native groundcover, erosion control matting (e.g., coir or jute matting), river stone, or pea gravel. The decision regarding the type of surface cover to use should be based on function, expected pedestrian traffic, cost, and maintenance. When alternative surface covers are used, methods to discourage pedestrian traffic should be considered. Stone or gravel are not recommended in parking lot applications, since they increase soil temperature and have low water-holding capacity.
- **Media for Turf Cover.** One adaptation suggested for use with turf cover is to design the filter media primarily as a sand filter with organic content only at the top. Compost, as specified in Appendix K, tilled into the top layers will provide organic content for the vegetative cover. If grass is the only vegetation, the ratio of organic matter in the filter media composition may be reduced.

**Choking Layer.** A 2 to 4 inch layer of choker stone (e.g., typically ASTM D448 No. 8 or No. 89 washed gravel) should be placed beneath the soil media and over the underdrain stone.

**Geotextile.** If the available head is limited, or the depth of the practice is a concern, geotextile fabric may be used in place of the choking layer. An appropriate geotextile fabric that complies with AASHTO M-288 Class 2, latest edition, requirements, and has a permeability of at least an order of magnitude higher (10x) than the soil subgrade permeability must be used. Geotextile fabric may be used on the sides of bioretention areas, as well.

**Underdrains.** Many bioretention designs will require an underdrain (see Section 3.6.1 Bioretention Feasibility Criteria). The underdrain should be a 4- or 6-inch perforated schedule 40 PVC pipe, or equivalent corrugated HDPE for small bioretention BMPs, with 3/8-inch

perforations at 6 inches on center. The underdrain must be encased in a layer of clean, washed ASTM D448 No.57 or smaller (No. 68, 8, or 89) stone. The underdrain must be sized so that the bioretention BMP fully drains within 72 hours or less.

Multiple underdrains are necessary for bioretention areas wider than 40 feet, and each underdrain must be located no more than 20 feet from the next pipe or the edge of the bioretention. (For long and narrow applications, a single underdrain running the length of the bioretention is sufficient.)

All traditional bioretention practices must include at least one observation well and/or cleanout pipe (minimum 4 inches in diameter). The observation wells should be tied into any of the Ts or Ys in the underdrain system and must extend upward above the surface of the bioretention area.

**Underground Storage Layer (optional).** For bioretention systems with an underdrain, an underground storage layer consisting of chambers, perforated pipe, stone, or other acceptable material can be incorporated below the filter media layer and underdrain to increase the infiltration sump volume or the storage for larger storm events. To qualify for the Enhanced Design, this storage layer must be designed to infiltrate in 72 hours, at ½ the measured infiltration rate. The may also be designed to provide detention for the 2-year, 15-year, or 100-year storms, as needed. The depth and volume of the storage layer will then depend on the target storage volumes needed to meet the applicable detention criteria.

**Impermeable Liner.** An impermeable liner is not typically required, although it may be utilized in fill applications where deemed necessary by a geotechnical investigation, on sites with contaminated soils, or on the sides of the practice to protect adjacent structures from seepage. Use a 30-mililiter (minimum) PVC geomembrane liner. (Follow manufacturer’s instructions for installation.) Field seams must be sealed according to the liner manufacturer’s specifications. A minimum 6-inch overlap of material is required at all seams.

**Material Specifications.** Recommended material specifications for bioretention areas are shown in Table 3.22.

**Table 3.22 Bioretention Material Specifications**

Material	Specification	Notes
Filter Media	<ul style="list-style-type: none"> <li>▪ See Table 3.20</li> </ul>	Minimum depth of 24 inches (18 inches for small-scale practices) To account for settling/compaction, it is recommended that 110% of the plan volume be utilized.
Mulch Layer	Use aged, shredded hardwood bark mulch	Lay a 2 to 3-inch layer on the surface of the filter bed.
Alternative Surface Cover	Use river stone or pea gravel, coir and jute matting, or turf cover.	Lay a 2 to 3-inch layer of to suppress weed growth.

Material	Specification	Notes
Top Soil For Turf Cover	Loamy sand or sandy loam texture, with less than 5% clay content, pH corrected to between 6 and 7, and an organic matter content of at least 2%.	3-inch tilled into surface layer.
Geotextile or Choking Layer	An appropriate geotextile fabric that complies with AASHTO M-288 Class 2, latest edition, requirements and has a permeability of at least an order of magnitude higher (10x) than the soil subgrade permeability must be used	Can use in place of the choking layer where the depth of the practice is limited. Geotextile fabric may be used on the sides of bioretention areas, as well.
	Lay a 2 to 4 inch layer of choker stone (e.g., typically No.8 or No.89 washed gravel) over the underdrain stone.	
Underdrain stone	1-inch diameter stone must be double-washed and clean and free of all fines (e.g., ASTM D448 No. 57 or smaller stone).	At least 2 inches above and below the underdrain.
Storage Layer (optional)	To increase storage for larger storm events, chambers, perforated pipe, stone, or other acceptable material can be incorporated below the filter media layer	
Impermeable Liner (optional)	Where appropriate, use a thirty mil (minimum) PVC Geomembrane liner	
Underdrains, Cleanouts, and Observation Wells	Use 4- or 6-inch rigid schedule 40 PVC pipe, or equivalent corrugated HDPE for small bioretention BMPs, with 3/8-inch perforations at 6 inches on center. Multiple underdrains are necessary for bioretention areas wider than 40 feet, and each underdrain must be located no more than 20 feet from the next pipe or the edge of the bioretention.	Lay the perforated pipe under the length of the bioretention cell, and install non-perforated pipe as needed to connect with the storm drain system or to daylight in a stabilized conveyance. Install T's and Y's as needed, depending on the underdrain configuration. Extend cleanout pipes to the surface .
Plant Materials	See Section 3.6.5 Bioretention Landscaping Criteria	Establish plant materials as specified in the landscaping plan and the recommended plant list.

**Signage.** Bioretention units in highly urbanized areas should be stenciled or otherwise permanently marked to designate it as a stormwater management facility. The stencil or plaque should indicate (1) its water quality purpose, (2) that it may pond briefly after a storm, and (3) that it is not to be disturbed except for required maintenance.

**Specific Design Issues for Streetscape Bioretention (B-2).** Streetscape bioretention is installed in the road right-of way either in the sidewalk area or in the road itself. In many cases, streetscape bioretention areas can also serve as a traffic calming or street parking control devices. The basic design adaptation is to move the raised concrete curb closer to the street or in the street, and then create inlets or curb cuts that divert street runoff into depressed vegetated areas within the right-of-way. Roadway stability can be a design issue where streetscape bioretention practices are installed. Designers should consult design standards pertaining to roadway drainage. It may be necessary to provide an impermeable liner on the road side of the bioretention area to keep water from saturating the road's sub-base.

**Specific Design Issues for Engineered Tree Boxes (B-3).** Engineered tree boxes are installed in the sidewalk zone near the street where urban street trees are normally installed. The soil volume



for the tree pit is increased and used to capture and treat stormwater. Treatment is increased by using a series of connected tree planting areas together in a row. The surface of the enlarged planting area may be mulch, grates, permeable pavers, or conventional pavement. The large and shared rooting space and a reliable water supply increase the growth and survival rates in this otherwise harsh planting environment.

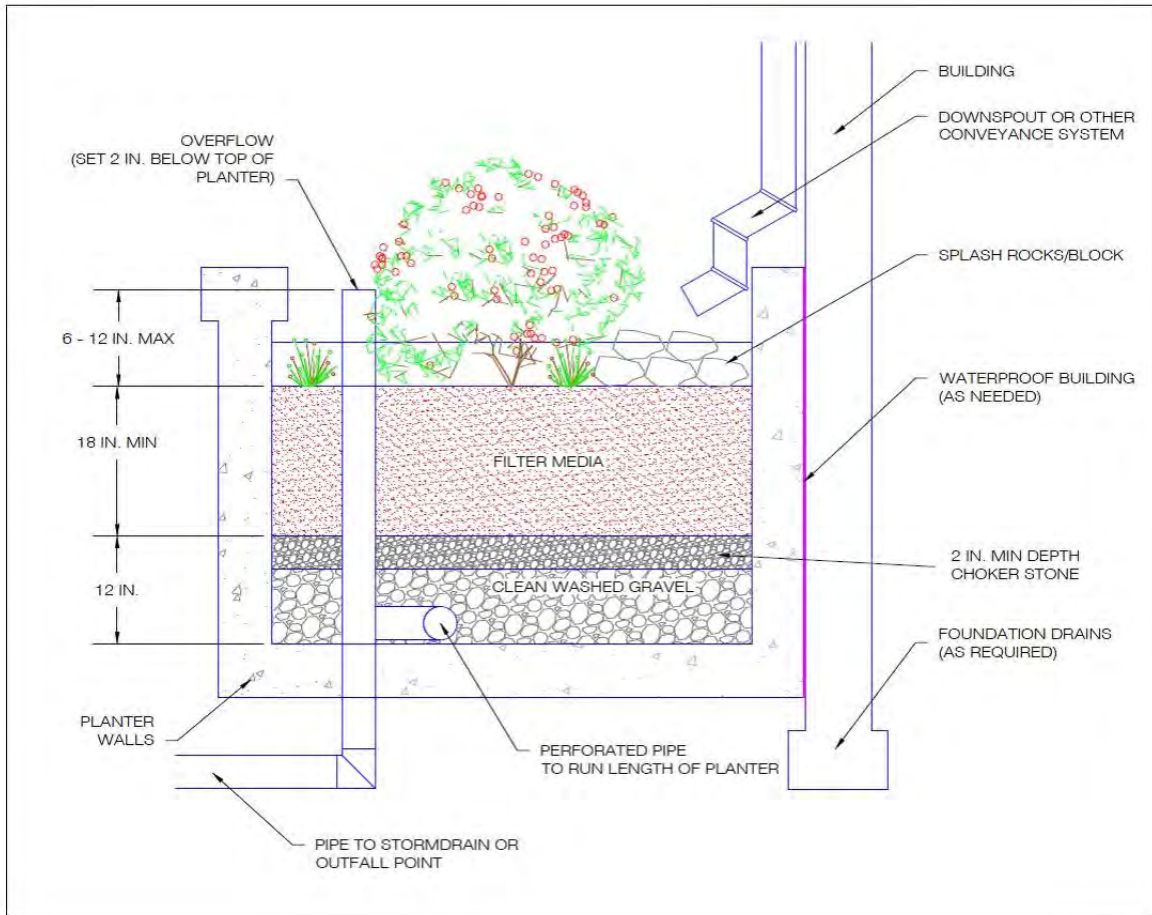
When designing engineered tree boxes, the following criteria must be considered:

- The bottom of the soil layer must be a minimum of 4 inches below the root ball of plants to be installed.
- Engineered tree box designs sometimes cover portions of the filter media with pervious pavers or cantilevered sidewalks. In these situations, it is important that the filter media is connected beneath the surface so that stormwater and tree roots can share this space.
- Installing an engineered tree pit grate over filter bed media is one possible solution to prevent pedestrian traffic and trash accumulation.
- Low, wrought iron fences can help restrict pedestrian traffic across the tree pit bed and serve as a protective barrier if there is a drop-off from the pavement to the micro-bioretenion cell.
- A removable grate may be used to allow the tree to grow through it.
- Each tree needs a minimum rootable soil volume as described in Section 3.14.

**Specific Design Issues for Stormwater Planters (B-4).** Stormwater planters are a useful option to disconnect and treat rooftop runoff, particularly in ultra-urban areas. They consist of confined planters that store and/or infiltrate runoff in a soil bed to reduce runoff volumes and pollutant loads. Stormwater planters combine an aesthetic landscaping feature with a functional form of stormwater treatment. Stormwater planters generally receive runoff from adjacent rooftop downspouts and are landscaped with plants that are tolerant to periods of both drought and inundation. The two basic design variations for stormwater planters are the infiltration planter and the filter planter. A filter planter is illustrated in Figure 3.2 below.

An infiltration planter filters rooftop runoff through soil in the planter followed by infiltration into soils below the planter. The minimum filter media depth is 18 inches, with the shape and length determined by architectural considerations. Infiltration planters should be placed at least 10 feet away from a building to prevent possible flooding or basement seepage damage.

A filter planter does not allow for infiltration and is constructed with a watertight concrete shell or an impermeable liner on the bottom to prevent seepage. Since a filter planter is self-contained and does not infiltrate into the ground, it can be installed right next to a building. The minimum filter media depth is 18 inches, with the shape and length determined by architectural considerations. Runoff is captured and temporarily ponded above the planter bed. Overflow pipes are installed to discharge runoff when maximum ponding depths are exceeded, to avoid water spilling over the side of the planter. In addition, an underdrain is used to carry runoff to the storm sewer system.



**Figure 3.20 Example of a stormwater planter (B-4).**

All planters should be placed at grade level or above ground. Plant materials must be capable of withstanding moist and seasonally dry conditions. The sand and gravel on the bottom of the planter should have a minimum infiltration rate of 5 inches per hour. The planter can be constructed of stone, concrete, brick, wood, or other durable material. If treated wood is used, care should be taken so that trace metals and creosote do not leach out of the planter.

**Specific Design Issues for Residential Rain Gardens (B-5).** For some residential applications, front, side, and/or rear yard bioretention may be an attractive option. This form of bioretention captures roof, lawn, and driveway runoff from low- to medium- density residential lots in a depressed area (i.e., 6 to 12 inches) between the home and the primary stormwater conveyance system (i.e., roadside ditch or pipe system). The bioretention area connects to the drainage system with an underdrain.

The bioretention filter media must be at least 18 inches deep. The underdrain is directly connected into the storm drain pipe running underneath the street or in the street right-of-way. A trench needs to be excavated during construction to connect the underdrain to the street storm drain system.

Construction of the remainder of the bioretention system is deferred until after the lot has been stabilized. Residential rain gardens require regular maintenance to perform effectively.

**BMP Sizing.** Bioretention is typically sized to capture the SWR<sub>v</sub> or larger design storm volumes in the surface ponding area, soil media, and gravel reservoir layers of the BMP.

Total storage volume of the BMP is calculated using Equation 3.5.

### Equation 3.5 Bioretention Storage Volume

$$Sv = SA_{bottom} \times [(d_{media} \times \eta_{media}) + (d_{gravel} \times \eta_{gravel})] + (SA_{average} \times d_{ponding})$$

where:

$Sv$	=	total storage volume of bioretention (ft <sup>3</sup> )
$SA_{bottom}$	=	bottom surface area of bioretention (ft <sup>2</sup> )
$d_{media}$	=	depth of the filter media (ft)
$\eta_{media}$	=	effective porosity of the filter media (typically 0.25)
$d_{gravel}$	=	depth of the underdrain and underground storage gravel layer (ft)
$\eta_{gravel}$	=	effective porosity of the gravel layer (typically 0.4)
$SA_{average}$	=	average surface area of bioretention (ft <sup>2</sup> ) (typically = $\frac{1}{2} \times$ (top area + bottom area) $\times SA_{bottom}$ )
$d_{ponding}$	=	maximum ponding depth of bioretention (ft)

Equation 3.5 can be modified if the storage depths of the filter media, gravel layer, or ponded water vary in the actual design or with the addition of any surface or subsurface storage components (e.g., additional area of surface ponding, subsurface storage chambers, etc.). The maximum depth of ponding in the bioretention must not exceed 18 inches. If storage practices will be provided off-line or in series with the bioretention area, the storage practices should be sized using the guidance in Section 3.12.

Bioretention can be designed to address, in whole or in part, the detention storage needed to comply with channel protection and/or flood control requirements. The  $Sv$  can be counted as part of the 2-year or 15-year runoff volumes to satisfy stormwater quantity control requirements. At least 3–6 inches of freeboard are required between the top of the overflow device and the top of the bioretention area when bioretention is used as detention storage for 2-year and 15-year storms.

Note: In order to increase the storage volume of a bioretention area, the ponding surface area may be increased beyond the filter media surface area. However, the top surface area of the practice (i.e., at the top of the ponding elevation) may not be more than twice the size of the surface area of the filter media ( $SA_{bottom}$ ).

### 3.6.5 Bioretention Landscaping Criteria

Landscaping is critical to the performance and function of bioretention areas. Therefore, a landscaping plan shall be provided for bioretention areas.

Minimum plan elements include the proposed bioretention template to be used, delineation of planting areas, and the planting plan including the following:

- Common and botanical names of the plants used
- Size of planted materials
- Mature size of the plants
- Light requirements
- Maintenance requirements
- Source of planting stock
- Any other specifications
- Planting sequence

It is recommended that the planting plan be prepared by a qualified landscape architect professional (e.g. licensed professional landscape architect, certified horticulturalist) in order to tailor the planting plan to the site-specific conditions.

Native plant species are preferred over non-native species, but some ornamental species may be used for landscaping effect if they are not aggressive or invasive. Some popular native species that work well in bioretention areas and are commercially available can be found in Table 3.23 and Table 3.24. Internet links to more detailed bioretention plant lists developed in the Chesapeake Bay region are provided below:

- Prince Georges County, MD  
[http://www.princegeorgescountymd.gov/Government/AgencyIndex/DER/ESG/Bioretention/pdf/Bioretention%20Manual\\_2009%20Version.pdf](http://www.princegeorgescountymd.gov/Government/AgencyIndex/DER/ESG/Bioretention/pdf/Bioretention%20Manual_2009%20Version.pdf)
- Delaware Green Technology Standards and Specifications  
[http://www.dnrec.state.de.us/DNREC2000/Divisions/Soil/Stormwater/New/GT\\_Std%20&%20Specs\\_06-05.pdf](http://www.dnrec.state.de.us/DNREC2000/Divisions/Soil/Stormwater/New/GT_Std%20&%20Specs_06-05.pdf)

The degree of landscape maintenance that can be provided will determine some of the planting choices for urban bioretention areas. Plant selection differs if the area will be frequently mowed, pruned, and weeded, in contrast to a site which will receive minimum annual maintenance. In areas where less maintenance will be provided and where trash accumulation in shrubbery or herbaceous plants is a concern, consider a “turf and trees” landscaping model where the turf is mowed along with other turf areas on the site. Spaces for herbaceous flowering plants can be included.

**Table 3.23 Herbaceous Plants Appropriate for Bioretention Areas in the District**

Plant	Light	Wetland Indicator <sup>1</sup>	Plant Form	Inundation Tolerance	Notes
Aster, New York ( <i>Aster novi-belgii</i> )	Full Sun- Part Shade	FACW+	Perennial	Yes	Attractive flowers; tolerates poor soils
Aster, New England ( <i>Aster novae-angliae</i> )	Full Sun- Part Shade	FACW	Perennial	Yes	Attractive flowers
Aster, Perennial Saltmarsh ( <i>Aster tenuifolius</i> )	Full Sun- Part Shade	OBL	Perennial	Yes	Salt tolerant
Coreopsis, Threadleaf ( <i>Coreopsis verticillata</i> )	Full Sun- Part Shade	FAC	Perennial	No	Drought tolerant
Beardtongue ( <i>Penstemon digitalis</i> )	Full Sun	FAC	Perennial	No	Tolerates poor drainage
Beebalm ( <i>Monarda didyma</i> )	Full Sun- Part Shade	FAC+	Perennial	Saturated	Herbal uses; attractive flower
Black-Eyed Susan ( <i>Rudbeckia hirta</i> )	Full Sun- Part Shade	FACU	Perennial	No	Common; Maryland state flower
Bluebells, Virginia ( <i>Mertensia virginica</i> )	Part Shade- Full Shade	FACW	Perennial	Yes	Attractive flower; dormant in summer
Blueflag, Virginia ( <i>Iris virginica</i> )	Full Sun- Part Shade	OBL	Perennial	Yes	Tolerates standing water
Bluestem, Big ( <i>Andropogon gerardii</i> )	Full Sun	FAC	Grass	No	Attractive in winter; forms clumps
Bluestem, Little ( <i>Schizachyrium scoparium</i> )	Full Sun	FACU	Grass	No	Tolerates poor soil conditions
Broom-Sedge ( <i>Andropogon virginicus</i> )	Full Sun	FACU	Grass	No	Drought tolerant; attractive fall color
Cardinal Flower ( <i>Lobelia cardinalis</i> )	Full Sun- Part Shade	FACW+	Perennial	Yes	Long boom time
Fern, New York ( <i>Thelypteris noveboracensis</i> )	Part Shade- Full Shade	FAC	Fern	Saturated	Drought tolerant; spreads
Fern, Royal ( <i>Osmunda regalis</i> )	Full Sun- Full Shade	OBL	Fern	Saturated	Tolerates short term flooding; drought tolerant
Fescue, Red ( <i>Festuca rubra</i> )	Full Sun- Full Shade	FACU	Ground- cover	No	Moderate growth; good for erosion control
Iris, Blue Water ( <i>Iris versicolor</i> )	Full Sun- Part Shade	OBL	Perennial	0-6"	Spreads
Lobelia, Great Blue ( <i>Lobelia siphilitica</i> )	Part Shade- Full Shade	FACW+	Perennial	Yes	Blooms in late summer; bright blue flowers
Phlox, Meadow ( <i>Phlox maculata</i> )	Full Sun	FACW	Perennial	Yes	Aromatic; spreads
Sea-Oats ( <i>Uniola paniculata</i> )	Full Sun	FACU-	Grass	No	Salt tolerant; attractive seed heads
Swamp Milkweed ( <i>Asclepias incarnata</i> )	Full Sun- Part Shade	OBL	Perennial	Saturated	Drought tolerant
Switchgrass ( <i>Panicum virgatum</i> )	Full Sun	FAC	Grass	Seasonal	Adaptable; great erosion control

Plant	Light	Wetland Indicator <sup>1</sup>	Plant Form	Inundation Tolerance	Notes
Turtlehead, White ( <i>Chelone glabra</i> )	Full Sun- Part Shade	OBL	Perennial	Yes	Excellent growth; herbal uses
Violet, Common Blue ( <i>Viola papilionacea</i> )	Full Sun- Full Shade	FAC	Perennial	No	Stemless; spreads
Virginia Wild Rye ( <i>Elymus virginicus</i> )	Part Shade- Full Shade	FACW-	Grass	Yes	Adaptable

<sup>1</sup>Notes: FAC = Facultative, equally likely to occur in wetlands or non-wetlands (estimated probability 34%-66%).  
 FACU = Facultative Upland, usually occurs in non-wetlands (estimated probability 67%-99%), but occasionally found on wetlands (estimated probability 1%-33%).

FACW = FACW Facultative Wetland, usually occurs in wetlands (estimated probability 67%-99%), but occasionally found in non-wetlands.

OBL = Obligate Wetland, occurs almost always (estimated probability 99%) under natural conditions in wetlands.

Sources: Prince George’s County Maryland Bioretention Manual; Virginia DCR Stormwater Design Specification No. 9: Bioretention.

**Table 3.24 Woody Plants Appropriate for Bioretention Areas in the District**

Plant	Light	Wetland Indicator <sup>1</sup>	Plant Form	Inundation Tolerance	Notes
Arrow-wood ( <i>Viburnum dentatum</i> )	Full Sun- Part Shade	FAC	Shrub	Seasonal	Salt tolerant
River Birch ( <i>Betula nigra</i> )	Full Sun- Part Shade	FACW	Tree	Seasonal	Attractive bark
Bayberry, Northern ( <i>Myrica pennsylvanica</i> )	Full Sun- Part Shade	FAC	Shrub	Seasonal	Salt tolerant
Black Gum ( <i>Nyssa sylvatica</i> )	Full Sun- Part Shade	FACW+	Tree	Seasonal	Excellent fall color
Dwarf Azalea ( <i>Rhododendron atlanticum</i> )	Part Shade	FAC	Shrub	Yes	Long lived
Black-Haw ( <i>Viburnum prunifolium</i> )	Part Shade- Full Shade	FACU+	Shrub	Yes	Edible Fruit
Choke Cherry ( <i>Prunus virginiana</i> )	Full Sun	FACU+	Shrub	Yes	Tolerates some salt; can be maintained as hedge
Cedar, Eastern Red ( <i>Juniperus virginiana</i> )	Full Sun	FACU	Tree	No	Pollution tolerant
Cotton-wood, Eastern ( <i>Populus deltoides</i> )	Full Sun	FAC	Tree	Seasonal	Pollutant tolerant; salt tolerant
Silky Dogwood ( <i>Cornus amomum</i> )	Full Sun- Part Shade	FACW	Shrub	Seasonal	High wildlife value
Hackberry, Common ( <i>Celtis occidentalis</i> )	Full Sun- Full Shade	FACU	Tree	Seasonal	Pollution Tolerant
Hazelnut, American ( <i>Corylus americana</i> )	Part Shade	FACU	Shrub	No	Forms thickets; edible nut
Holly, Winterberry ( <i>Ilex laevigata</i> )	Full Sun- Part Shade	OBL	Shrub	Yes	Winter food source for birds

Plant	Light	Wetland Indicator <sup>1</sup>	Plant Form	Inundation Tolerance	Notes
Holly, American ( <i>Ilex opaca</i> )	Full Sun- Full Shade	FACU	Shrub- Tree	Limited	Pollution Tolerant
Maple, Red ( <i>Acer rubrum</i> )	Full Sun- Part Shade	FAC	Tree	Seasonal	Very adaptable; early spring flowers
Ninebark, Eastern ( <i>Physocarpus opulifolius</i> )	Full Sun- Part Shade	FACW-	Shrub	Yes	Drought tolerant; attractive bark
Oak, Pin ( <i>Quercus palustris</i> )	Full Sun	FACW	Tree	Yes	Pollution Tolerant
Pepperbush, Sweet ( <i>Clethra alnifolia</i> )	Part Shade- Full Shade	FAC+	Shrub	Seasonal	Salt tolerant
Winterberry, Common ( <i>Ilex verticillata</i> )	Full Sun- Full Shade	FACW+	Shrub	Seasonal	Winter food source for birds
Witch-Hazel, American ( <i>Hamamelia virginiana</i> )	Part Shade- Full Shade	FAC-	Shrub	No	Pollution tolerant

<sup>1</sup>Notes:

FAC = Facultative, equally likely to occur in wetlands or non-wetlands (estimated probability 34%-66%).

FACU = Facultative Upland, usually occurs in non-wetlands (estimated probability 67%-99%), but occasionally found on wetlands (estimated probability 1%-33%).

FACW = FACW Facultative Wetland, usually occurs in wetlands (estimated probability 67%-99%), but occasionally found in non-wetlands.

OBL = Obligate Wetland, occurs almost always (estimated probability 99%) under natural conditions in wetlands.

Sources: Prince George’s County Maryland Bioretention Manual; Virginia DCR Stormwater Design Specification No. 9: Bioretention

Planting recommendations for bioretention facilities are as follows:

- The primary objective of the planting plan is to cover as much of the surface areas of the filter bed as quickly as possible. Herbaceous or ground cover layers are as or more important than more widely spaced trees and shrubs.
- Native plant species should be specified over non-native species.
- Plants should be selected based on a specified zone of hydric tolerance and must be capable of surviving both wet and dry conditions (“Wet footed” species should be planted near the center, whereas upland species do better planted near the edge).
- Woody vegetation should not be located at points of inflow; trees should not be planted directly above underdrains but should be located closer to the perimeter.
- Shrubs and herbaceous vegetation should generally be planted in clusters and at higher densities (i.e., 10 feet on-center and 1 to 1.5 feet on-center, respectively).
- If trees are part of the planting plan, a tree density of approximately one tree per 250 square feet (i.e., 15 feet on-center) is recommended.
- Designers should also remember that planting holes for trees must be at least 3 feet deep to provide enough soil volume for the root structure of mature trees. This applies even if the remaining soil media layer is shallower than 3 feet.

- Tree species should be those that are known to survive well in the compacted soils and the polluted air and water of an urban landscape.
- If trees are used, plant shade-tolerant ground covers within the drip line.
- If the bioretention area is to be used for snow storage or is to accept snowmelt runoff, it should be planted with salt-tolerant, herbaceous perennials.

### 3.6.6 Bioretention Construction Sequence

**Erosion and Sediment Controls.** Bioretention areas should be fully protected by silt fence or construction fencing. Bioretention areas intended to infiltrate runoff must remain outside the limit of disturbance during construction to prevent soil compaction by heavy equipment. Where this is infeasible, the impacted area cannot be excavated below 2 feet above the final design elevation of the bottom of the bioretention until further compaction by heavy equipment can be avoided. Once the area is excavated to grade, the impacted area must be tilled to a depth of 12 inches below the bottom of the bioretention. If these excavation/compaction limitations cannot be met, infiltration tests will be required prior to installation of the permeable pavement to ensure that the design infiltration rate is still present.

Large bioretention applications may be used as small sediment traps or basins during construction. However, these must be accompanied by notes and graphic details on the erosion and sediment control plan specifying that (1) the maximum excavation depth of the trap or basin at the construction stage must be at least 1 foot higher than the post-construction (final) invert (bottom of the facility), and (2) the facility must contain an underdrain. The plan must also show the proper procedures for converting the temporary sediment control practice to a permanent bioretention BMP, including dewatering, cleanout, and stabilization.

**Bioretention Installation.** The following is a typical construction sequence to properly install a bioretention basin. The construction sequence for micro-bioretention is more simplified. These steps may be modified to reflect different bioretention applications or expected site conditions:

**Step 1:** Construction of the bioretention area may only begin after the entire contributing drainage area has been stabilized with vegetation. It may be necessary to block certain curb or other inlets while the bioretention area is being constructed. The proposed site should be checked for existing utilities prior to any excavation.

**Step 2:** The designer, the installer, and DDOE inspector must have a preconstruction meeting, checking the boundaries of the contributing drainage area and the actual inlet elevations to ensure they conform to original design. Since other contractors may be responsible for constructing portions of the site, it is quite common to find subtle differences in site grading, drainage and paving elevations that can produce hydraulically important differences for the proposed bioretention area. The designer should clearly communicate, in writing, any project changes determined during the preconstruction meeting to the installer and the inspector. Material certifications for aggregate, soil media, and any geotextiles must be submitted for approval to the inspector at the preconstruction meeting.

**Step 3:** Temporary erosion and sediment controls (e.g., diversion dikes, reinforced silt fences) are needed during construction of the bioretention area to divert stormwater away from the



bioretention area until it is completed. Special protection measures, such as erosion control fabrics, may be needed to protect vulnerable side slopes from erosion during the construction process.

**Step 4:** Any pretreatment cells should be excavated first and then sealed to trap sediments.

**Step 5:** Excavators or backhoes should work from the sides to excavate the bioretention area to its appropriate design depth and dimensions. Excavating equipment should have scoops with adequate reach so they do not have to sit inside the footprint of the bioretention area. Contractors should use a cell construction approach in larger bioretention basins, whereby the basin is split into 500- to 1,000-square foot temporary cells with a 10- to 15-foot earth bridge in between, so that cells can be excavated from the side.

**Step 6:** It may be necessary to rip the bottom soils to a depth of 6 to 12 inches to promote greater infiltration.

**Step 7:** If using a geotextile fabric, place the fabric on the sides of the bioretention area with a 6-inch overlap on the sides. If a stone storage layer will be used, place the appropriate depth of No. 57 stone on the bottom, install the perforated underdrain pipe, pack No. 57 stone to 3 inches above the underdrain pipe, and add the choking layer or appropriate geotextile layer as a filter between the underdrain and the soil media layer. If no stone storage layer is used, start with 6 inches of No. 57 stone on the bottom and proceed with the layering as described above.

**Step 8:** Apply the media in 12-inch lifts until the desired top elevation of the bioretention area is achieved. Wait a few days to check for settlement and add additional media, as needed, to achieve the design elevation. Note: The batch receipt confirming the source of the soil media must be submitted to the DDOE inspector.

**Step 9:** Prepare planting holes for any trees and shrubs, install the vegetation, and water accordingly. Install any temporary irrigation.

**Step 10:** Install the plant materials as shown in the landscaping plan, and water them as needed.

**Step 11:** Place the surface cover (i.e., mulch, river stone, or turf) in both cells, depending on the design. If coir or jute matting will be used in lieu of mulch, the matting will need to be installed prior to planting (Step 10), and holes or slits will have to be cut in the matting to install the plants.

**Step 12:** If curb cuts or inlets are blocked during bioretention installation, unblock these after the drainage area and side slopes have good vegetative cover. It is recommended that unblocking curb cuts and inlets take place after two to three storm events if the drainage area includes newly installed asphalt, since new asphalt tends to produce a lot of fines and grit during the first several storms.

**Step 13:** Conduct the final construction inspection using a qualified professional, providing DDOE with an as-built, then log the GPS coordinates for each bioretention facility, and submit them for entry into the maintenance tracking database.

**Construction Supervision.** Supervision during construction is recommended to ensure that the bioretention area is built in accordance with the approved design and this specification. Qualified individuals should use detailed inspection checklists that include sign-offs at critical stages of

construction, to ensure that the contractor’s interpretation of the plan is consistent with the designer’s intentions.

DDOE’s construction phase inspection checklist can be found in Appendix L.

### 3.6.7 Bioretention Maintenance Criteria

When bioretention practices are installed, it is the owner’s responsibility to ensure they, or those managing the practice, (1) be educated about their routine maintenance needs, (2) understand the long-term maintenance plan, and (3) be subject to a maintenance covenant or agreement, as described below.

Maintenance of bioretention areas should be integrated into routine landscape maintenance tasks. If landscaping contractors will be expected to perform maintenance, their contracts should contain specifics on unique bioretention landscaping needs, such as maintaining elevation differences needed for ponding, proper mulching, sediment and trash removal, and limited use of fertilizers and pesticides.

Maintenance tasks and frequency will vary depending on the size and location of the bioretention, the landscaping template chosen, and the type of surface cover in the practice. A generalized summary of common maintenance tasks and their frequency is provided in Table 3.25.

**Table 3.25 Typical Maintenance Tasks for Bioretention Practices**

Frequency	Maintenance Tasks
Upon establishment	<ul style="list-style-type: none"> <li>▪ For the first 6 months following construction, the practice and CDA should be inspected at least twice after storm events that exceed 1/2 inch of rainfall. Conduct any needed repairs or stabilization.</li> <li>▪ Inspectors should look for bare or eroding areas in the contributing drainage area or around the bioretention area, and make sure they are immediately stabilized with grass cover.</li> <li>▪ One-time, spot fertilization may be needed for initial plantings.</li> <li>▪ Watering is needed once a week during the first 2 months, and then as needed during first growing season (April-October), depending on rainfall.</li> <li>▪ Remove and replace dead plants. Up to 10% of the plant stock may die off in the first year, so construction contracts should include a care and replacement warranty to ensure that vegetation is properly established and survives during the first growing season following construction.</li> </ul>
At least 4 times per year	<ul style="list-style-type: none"> <li>▪ Mow grass filter strips and bioretention with turf cover</li> <li>▪ Check curb cuts and inlets for accumulated grit, leaves, and debris that may block inflow</li> </ul>
Twice during growing season	<ul style="list-style-type: none"> <li>▪ Spot weed, remove trash, and rake the mulch</li> </ul>
Annually	<ul style="list-style-type: none"> <li>▪ Conduct a maintenance inspection</li> <li>▪ Supplement mulch in devoid areas to maintain a 3 inch layer</li> <li>▪ Prune trees and shrubs</li> <li>▪ Remove sediment in pre-treatment cells and inflow points</li> </ul>

Frequency	Maintenance Tasks
Once every 2–3 years	<ul style="list-style-type: none"> <li>▪ Remove sediment in pre-treatment cells and inflow points</li> <li>▪ Remove and replace the mulch layer</li> </ul>
As needed	<ul style="list-style-type: none"> <li>▪ Add reinforcement planting to maintain desired vegetation density</li> <li>▪ Remove invasive plants using recommended control methods</li> <li>▪ Remove any dead or diseased plants</li> <li>▪ Stabilize the contributing drainage area to prevent erosion</li> </ul>

The most common non-routine maintenance problem involves standing water. If water remains on the surface for more than 72 hours after a storm, adjustments to the grading may be needed or underdrain repairs may be needed. The surface of the filter bed should also be checked for accumulated sediment or a fine crust that builds up after the first several storm events. There are several methods that can be used to rehabilitate the filter. These are listed below, starting with the simplest approach and ranging to more involved procedures (i.e., if the simpler actions do not solve the problem):

- Open the underdrain observation well or cleanout and pour in water to verify that the underdrains are functioning and not clogged or otherwise in need of repair. The purpose of this check is to see if there is standing water all the way down through the soil. If there is standing water on top, but not in the underdrain, then there is a clogged soil layer. If the underdrain and stand pipe indicates standing water, then the underdrain must be clogged and will need to be cleaned out.
- Remove accumulated sediment and till 2 to 3 inches of sand into the upper 6 to 12 inches of soil.
- Install sand wicks from 3 inches below the surface to the underdrain layer. This reduces the average concentration of fines in the media bed and promotes quicker drawdown times. Sand wicks can be installed by excavating or auguring (i.e., using a tree auger or similar tool) down to the top of the underdrain layer to create vertical columns which are then filled with a clean open-graded coarse sand material (e.g., ASTM C-33 concrete sand or similar approved sand mix for bioretention media). A sufficient number of wick drains of sufficient dimension should be installed to meet the design dewatering time for the facility.
- Remove and replace some or all of the soil media.

**Maintenance Inspections.** It is recommended that a qualified professional conduct a spring maintenance inspection and cleanup at each bioretention area. Maintenance inspections should include information about the inlets, the actual bioretention facility (sediment buildup, outlet conditions, etc.), and the state of vegetation (water stressed, dead, etc.) and are intended to highlight any issues that need or may need attention to maintain stormwater management functionality.

DDOE’s maintenance inspection checklists for bioretention areas can be found in Appendix M.

**Declaration of Covenants.** A declaration of covenants that includes all maintenance responsibilities to ensure the continued stormwater performance for the BMP is required. The

declaration of covenants specifies the property owner’s primary maintenance responsibilities, and authorizes DDOE staff to access the property for inspection or corrective action in the event the proper maintenance is not performed. The declaration of covenants is attached to the deed of the property. An example form is provided at the end of Chapter 5 though variations will exist for scenarios where stormwater crosses property lines. The covenant is between the property and the District Government. It is submitted through the Office of the Attorney General (OAG). All SWMPs have a maintenance agreement stamp that must be signed for a building permit to proceed. A maintenance schedule must appear on the SWMP. Additionally, a maintenance schedule is required in schedule c of the declaration of covenants.

Covenants are not required on government properties, but maintenance responsibilities must be defined through a partnership agreement or a memorandum of understanding.

**Waste Material.** Waste material from the repair, maintenance, or removal of a BMP or land cover shall be removed and disposed of in compliance with applicable federal and District law.

### 3.6.8 Bioretention Stormwater Compliance Calculations

Bioretention performance varies depending on the design configuration of the system.

**Enhanced Designs.** These designs are bioretention applications with no underdrain or at least 24 inches of filter media and an infiltration sump. Enhanced designs receive 100 percent retention value for the amount of storage volume (Sv) provided by the practice (Table 3.26), and therefore, are not considered an accepted TSS treatment practice.

**Table 3.26 Enhanced Bioretention Retention Value and Pollutant Removal**

Retention Value	= Sv
Accepted TSS Treatment Practice	N/A

**Standard Designs.** These designs are bioretention applications with an underdrain and less than 24 inches of filter media. Standard designs receive 60 percent retention value and are an accepted TSS removal practice for the amount of storage volume (Sv) provided by the practice (Table 3.27).

**Table 3.27 Standard Bioretention Design Retention Value and Pollutant Removal**

Retention Value	= 0.6 × Sv
Accepted TSS Treatment Practice	Yes

The practice must be sized using the guidance detailed in Section 3.6.4.

Note: Additional retention value can be achieved if trees are utilized as part of a bioretention area (see Section 3.2.3 Green Roof Pretreatment Criteria).

Bioretention also contributes to peak flow reduction. This contribution can be determined in several ways. One method is to subtract the  $S_v$  or  $R_v$  from the total runoff volume for the 2-year, 15-year, and 100-year storms. The resulting reduced runoff volumes can then be used to calculate a Reduced Natural Resource Conservation Service (NRCS) Curve Number for the site or drainage area. The Reduced Curve Number can then be used to calculate peak flow rates for the various storm events. Other hydrologic modeling tools that employ different procedures may be used as well.

### 3.6.9 References

- CWP. 2007. National Pollutant Removal Performance Database, Version 3.0. Center for Watershed Protection, Ellicott City, MD.
- Hirschman, D., L. Woodworth and S. Drescher. 2009. Technical Report: Stormwater BMPs in Virginia's James River Basin – An Assessment of Field Conditions and Programs. Center for Watershed Protection. Ellicott City, MD.
- Hunt, W.F. III and W.G. Lord. 2006. "Bioretention Performance, Design, Construction, and Maintenance." North Carolina Cooperative Extension Service Bulletin. Urban Waterways Series. AG-588-5. North Carolina State University. Raleigh, NC.
- Saxton, K.E., W.J. Rawls, J.S. Romberger, and R.I. Papendick. 1986. "Estimating generalized soil-water characteristics from texture." Soil Sci. Soc. Am. J. 50(4):1031-1036.
- Maryland Department of the Environment. 2001. Maryland Stormwater Design Manual. [http://www.mde.state.md.us/programs/Water/StormwaterManagementProgram/MarylandStormwaterDesignManual/Pages/Programs/WaterPrograms/SedimentandStormwater/stormwater\\_design/index.aspx](http://www.mde.state.md.us/programs/Water/StormwaterManagementProgram/MarylandStormwaterDesignManual/Pages/Programs/WaterPrograms/SedimentandStormwater/stormwater_design/index.aspx)
- Prince George's Co., MD. 2007. Bioretention Manual. Available online at: [http://www.princegeorgescountymd.gov/Government/AgencyIndex/DER/ESG/Bioretention/pdf/Bioretention%20Manual\\_2009%20Version.pdf](http://www.princegeorgescountymd.gov/Government/AgencyIndex/DER/ESG/Bioretention/pdf/Bioretention%20Manual_2009%20Version.pdf)
- Schueler, T. 2008. Technical Support for the Baywide Runoff Reduction Method. Chesapeake Stormwater Network. Baltimore, MD. [www.chesapeakestormwater.net](http://www.chesapeakestormwater.net)
- Smith, R.A. and Hunt, W.F. III. 1999. "Pollutant Removal in Bioretention Cells with Grass Cover"
- Smith, R. A., and Hunt, W.F. III. 2007. "Pollutant removal in bioretention cells with grass cover." Pp. 1-11 In: Proceedings of the World Environmental and Water Resources Congress 2007.
- Virginia DCR Stormwater Design Specification No. 9: Bioretention Version 1.8. 2010 .

Wisconsin Department of Natural Resources. *Storm Water Post-Construction Technical Standards*. [http://dnr.wi.gov/topic/stormwater/standards/postconst\\_standards.html](http://dnr.wi.gov/topic/stormwater/standards/postconst_standards.html)

### 3.7 Stormwater Filtering Systems

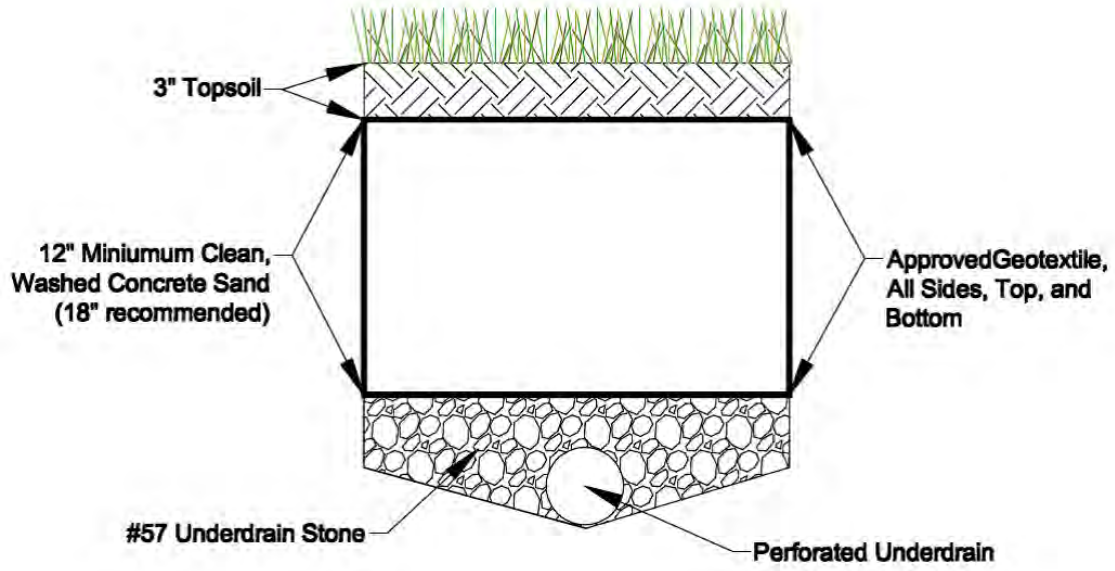
**Definition.** Practices that capture and temporarily store the design storm volume and pass it through a filter bed of sand media. Filtered runoff may be collected and returned to the conveyance system or allowed to partially infiltrate into the soil. Design variants include:

- F-1 Non-structural sand filter
- F-2 Surface sand filter
- F-3 Three-chamber underground sand filter
- F-4 Perimeter sand filter

Stormwater filters are a useful practice to treat stormwater runoff from small, highly impervious sites. Stormwater filters capture, temporarily store, and treat stormwater runoff by passing it through an engineered filter media, collecting the filtered water in an underdrain, and then returning it back to the storm drainage system. The filter consists of two chambers: the first is devoted to settling and the second serves as a filter bed consisting of a sand filter media.

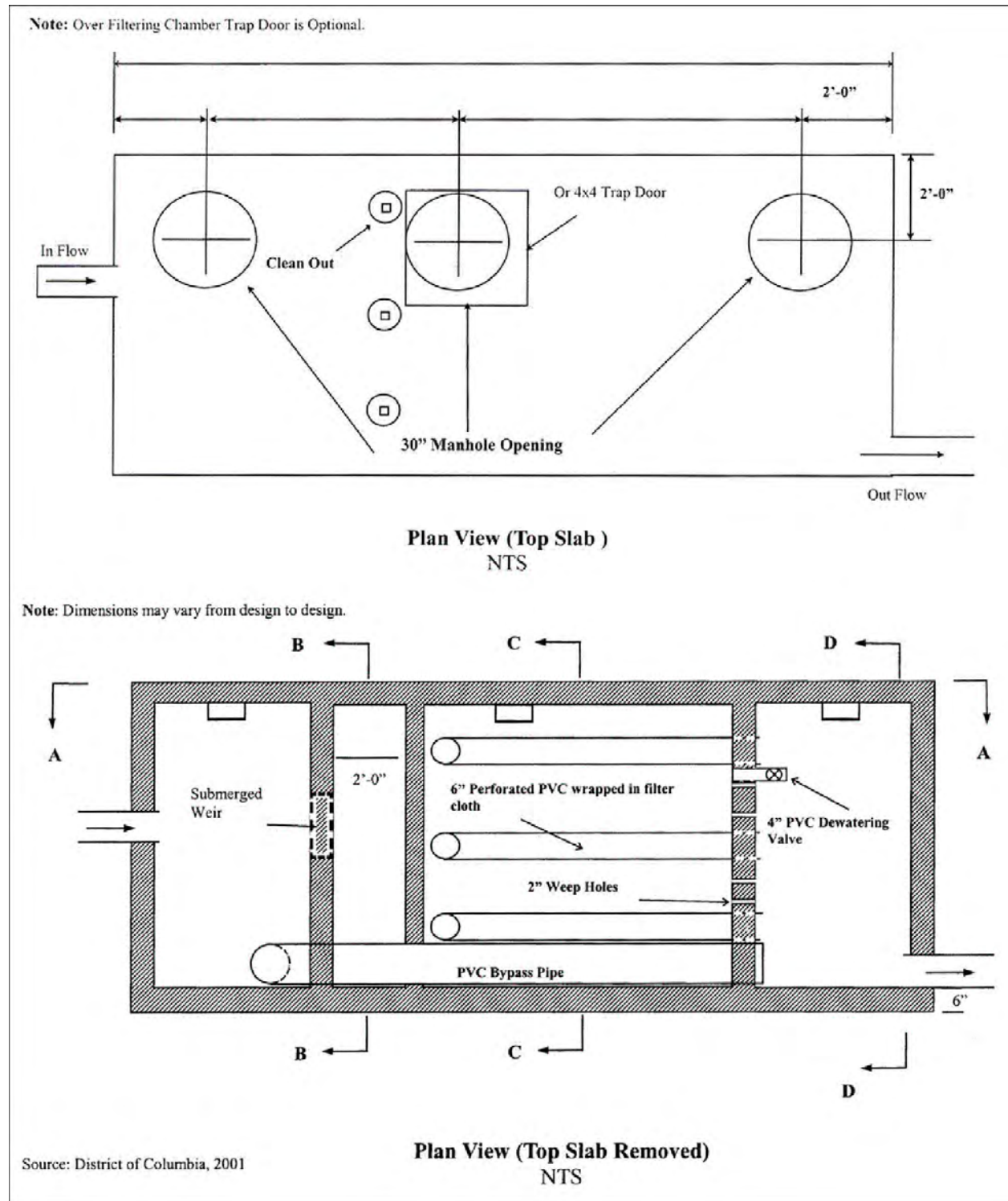
Stormwater filters are a versatile option because they consume very little surface land and have few site restrictions. They provide moderate pollutant removal performance at small sites where space is limited. However, filters have no retention capability, so designers should consider using up-gradient retention practices, which have the effect of decreasing the design storm volume and size of the filtering practices. Filtering practices are also suitable to provide special treatment at designated stormwater hotspots. A list of potential stormwater hotspots operations can be found in Appendix Q.

Filtering systems are typically not to be designed to provide stormwater detention (Qp2, Qp15), but they may be in some circumstances. Filtering practices are generally combined with separate facilities to provide this type of control. However, the three-chamber underground sand filter can be modified by expanding the first or settling chamber, or adding an extra chamber between the filter chamber and the clear well chamber to handle the detention volume, which is subsequently discharged at a predetermined rate through an orifice and weir combination.

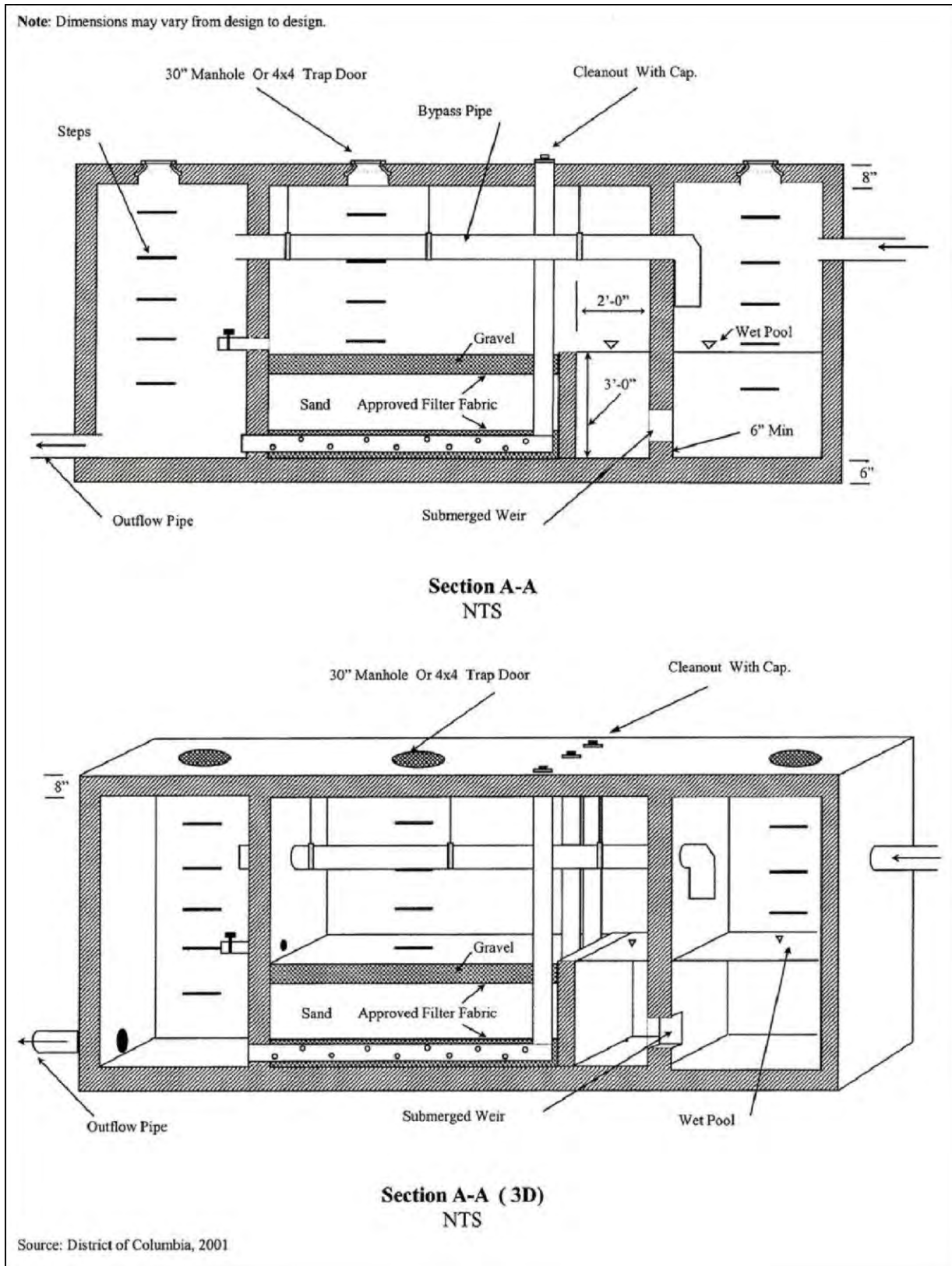


**Figure 3.21** Typical schematic for a surface sand filter (F-2).  
**Note:** Material specifications are indicated in Table 3.28.

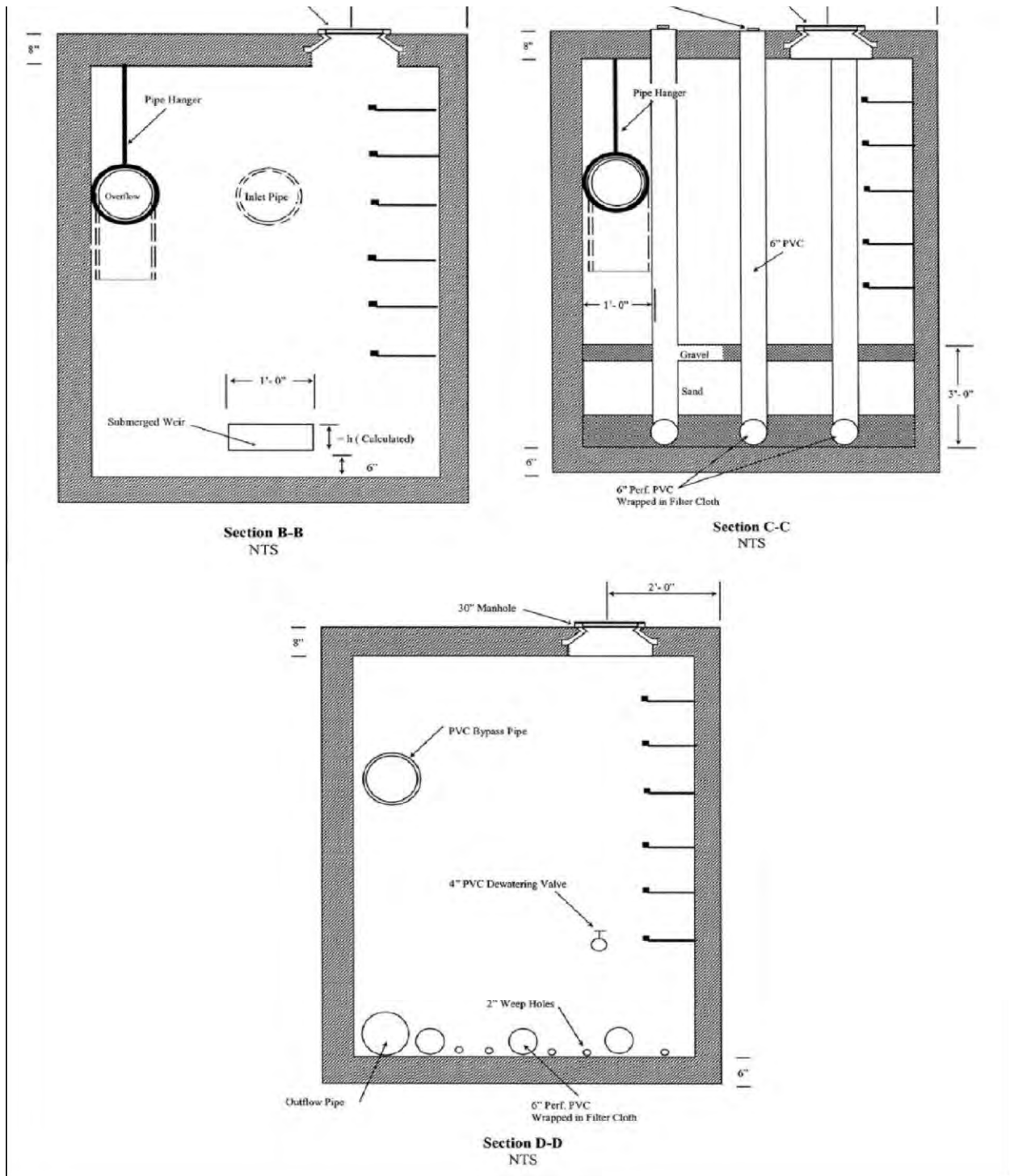




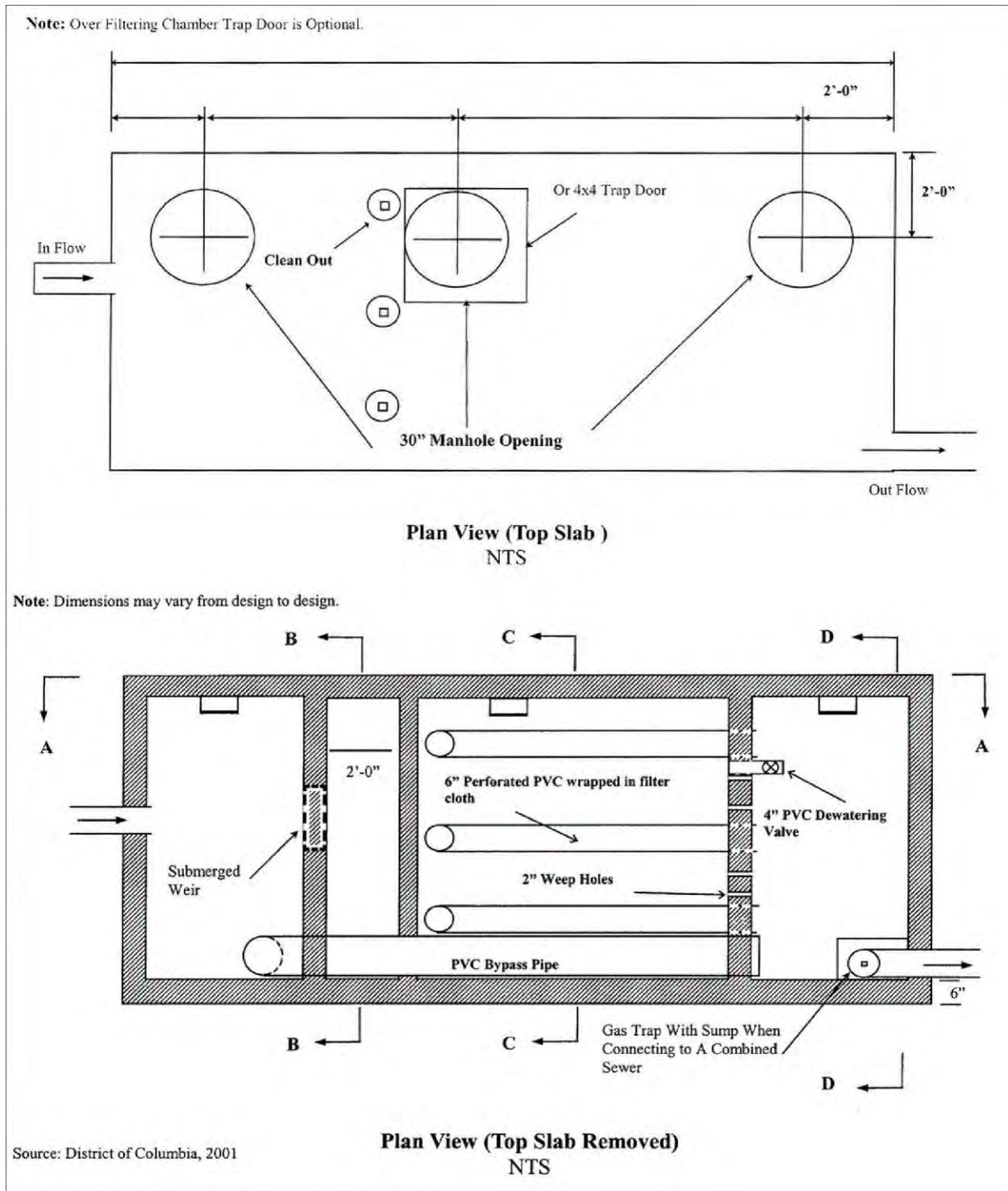
**Figure 3.22** Example of a three-chamber underground sand filter (F-3) for separate sewer areas.  
**Note:** Material specifications are indicated in Table 3.28.



**Figure 3.23** Example of a three-chamber underground sand filter (F-3) for separate sewer areas.  
**Note:** Material specifications are indicated in Table 3.28.



**Figure 3.24** Example of a three-chamber underground sand filter (F-3) for separate sewer areas. Note: Material specifications are indicated in Table 3.28.



**Figure 3.25** Example of a three-chamber underground sand filter (F-3) for combined sewer areas.  
**Note:** Material specifications are indicated in Table 3.28.

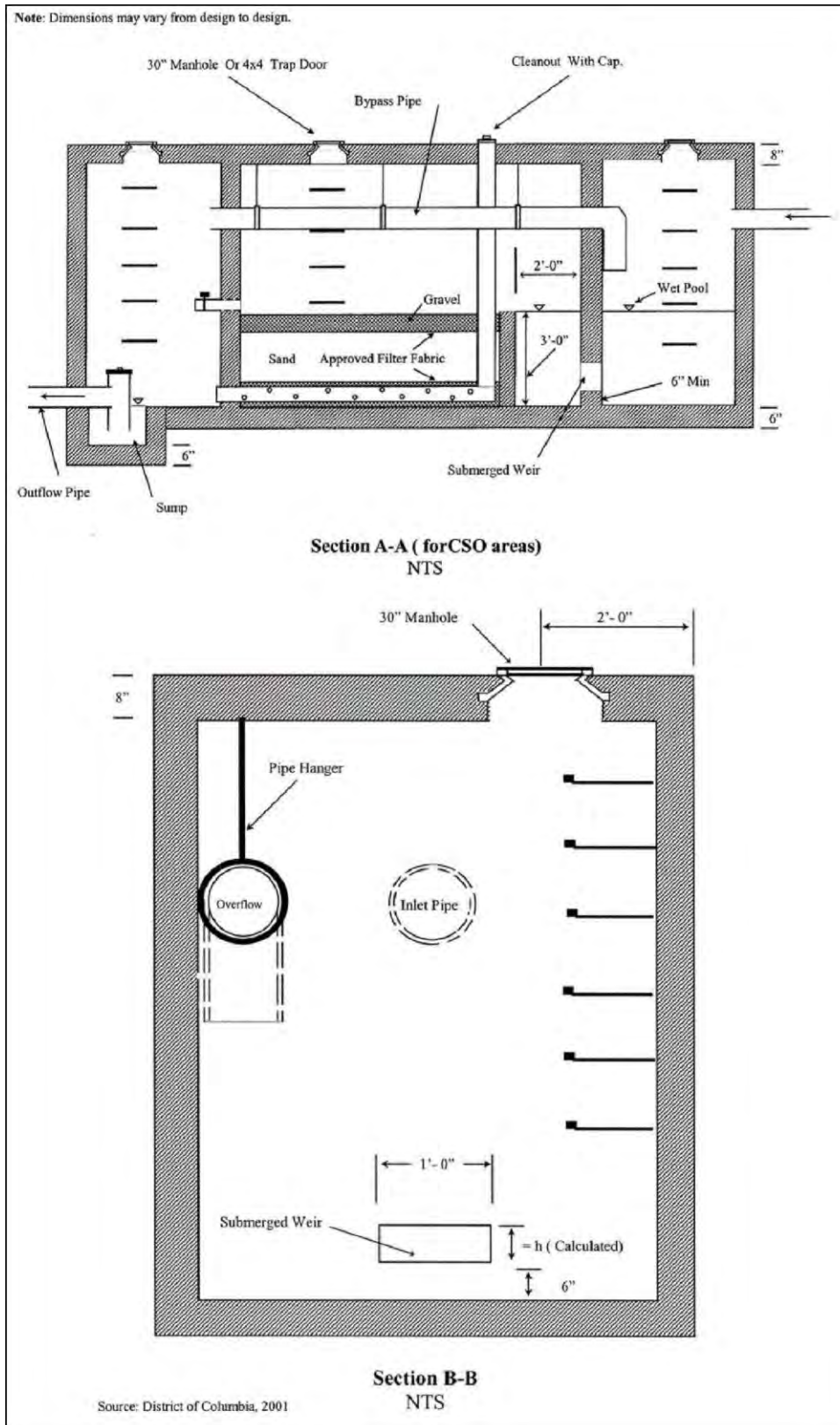
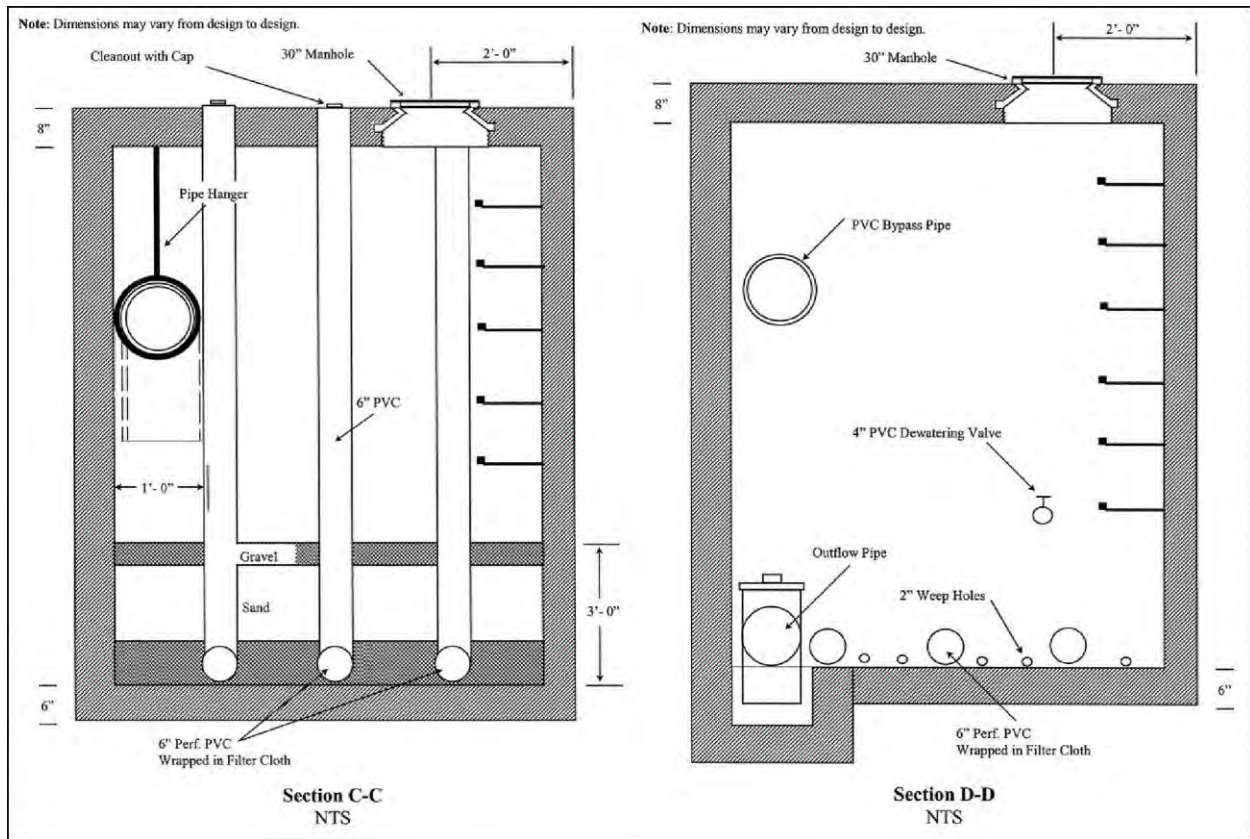


Figure 3.26 Example of a three-chamber underground sand filter (F-3) for combined sewer areas. Note: Material specifications are indicated in Table 3.28.



**Figure 3.27 Example of a three-chamber underground sand filter (F-3) for combined sewer areas. Note: Material specifications are indicated in Table 3.28.**

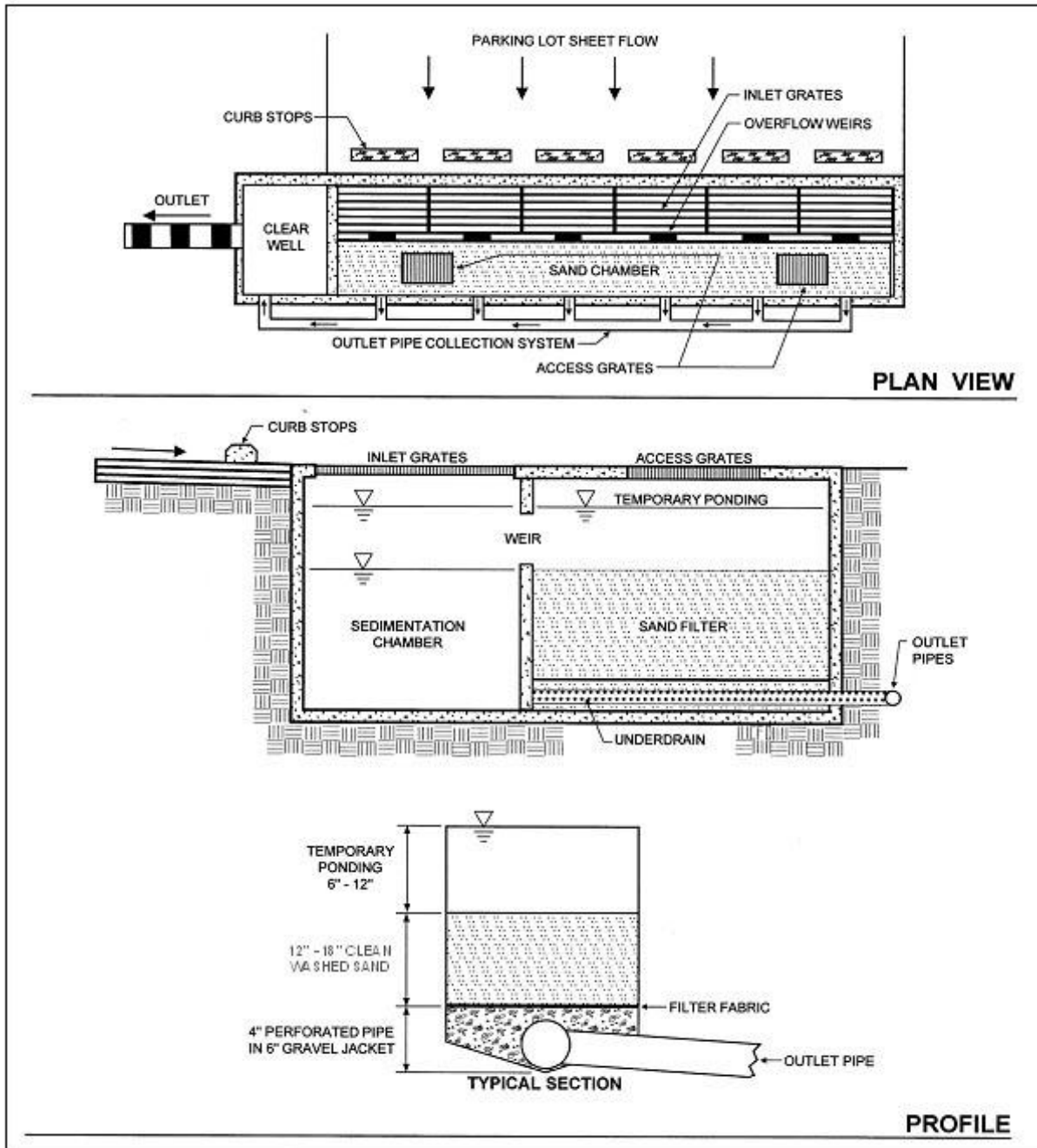


Figure 3.28 Example of a perimeter sand filter (F-4). Note: Material specifications are indicated in Table 3.28.

### 3.7.1 Filtering Feasibility Criteria

Stormwater filters can be applied to most types of urban land. They are not always cost-effective, given their high unit cost and small area served, but there are situations where they may clearly

be the best option for stormwater treatment (e.g., hotspot runoff treatment, small parking lots, ultra-urban areas, etc.). The following criteria apply to filtering practices:

**Available Hydraulic Head.** The principal design constraint for stormwater filters is available hydraulic head, which is defined as the vertical distance between the top elevation of the filter and the bottom elevation of the existing storm drain system that receives its discharge. The head required for stormwater filters ranges from 2 to 10 feet, depending on the design variant. It is difficult to employ filters in extremely flat terrain, since they require gravity flow through the filter. The only exception is the perimeter sand filter, which can be applied at sites with as little as 2 feet of head.

**Depth to Water Table and Bedrock.** The designer must assure a standard separation distance of at least 2 feet between the seasonally high groundwater table and/or bedrock layer and the bottom invert of the filtering practice.

**Contributing Drainage Area.** Filters are best applied on small sites where the contributing drainage (CDA) area is as close to 100 percent impervious as possible in order to reduce the risk that eroded sediments will clog the filter. If the CDA is pervious, then the vegetation must be dense and stable. Turf is acceptable (see Section 3.7.5 Filtering Landscaping Criteria). A maximum CDA of 5 acres is recommended for surface sand filters, and a maximum CDA of 2 acres is recommended for perimeter or underground filters. Filters have been used on larger drainage areas in the past, but greater clogging problems have typically resulted. The one-chamber sand filter is only applicable for impervious area less than 10,000 ft<sup>2</sup> (1/4 acre).

**Space Required.** The amount of space required for a filter practice depends on the design variant selected. Surface sand filters typically consume about 2 to 3 percent of the CDA, while perimeter sand filters typically consume less than 1 percent. Underground stormwater filters generally consume no surface area except their manholes.

**Land Use.** As noted above, filters are particularly well suited to treat runoff from stormwater hotspots and smaller parking lots. Other applications include redevelopment of commercial sites or when existing parking lots are renovated or expanded. Filters can work on most commercial, industrial, institutional, or municipal sites and can be located underground if surface area is not available.

**Site Topography.** Filters shall not be located on slopes greater than 6 percent.

**Utilities.** All utilities shall have a minimum 5-foot horizontal clearance from the filtering practice.

**Facility Access.** All filtering systems shall be located in areas where they are accessible for inspection and for maintenance (by vacuum trucks).

**Soils.** Soil conditions do not constrain the use of filters. At least one soil boring must be taken at a low point within the footprint of the proposed filtering practice to establish the water table and bedrock elevations and evaluate soil suitability. A geotechnical investigation is required for all underground stormwater Best Management Practices (BMPs), including underground filtering systems. Geotechnical testing requirements are outlined in Appendix P.



### 3.7.2 Filtering Conveyance Criteria

Most filtering practices are designed as off-line systems so that all flows enter the filter storage chamber until it reaches capacity, at which point larger flows are then diverted or bypassed around the filter to an outlet chamber and are not treated. Runoff from larger storm events must be bypassed using an overflow structure or a flow splitter. Claytor and Schueler (1996) and ARC (2001) provide design guidance for flow splitters for filtering practices.

Some underground filters will be designed and constructed as on-line BMPs. In these cases, designers must indicate how the device will safely pass larger storm events (e.g., the 15-year event) to a stabilized water course without resuspending or flushing previously trapped material.

All stormwater filters must be designed to drain or dewater within 72 hours after a storm event to reduce the potential for nuisance conditions.

### 3.7.3 Filtering Pretreatment Criteria

Adequate pretreatment is needed to prevent premature filter clogging and ensure filter longevity. Dry or wet pretreatment shall be provided prior to filter media. Pretreatment devices are subject to the following criteria:

- Sedimentation chambers are typically used for pretreatment to capture coarse sediment particles before they reach the filter bed.
- Sedimentation chambers may be wet or dry but must be sized to accommodate at least 25 percent of the total design storm volume (inclusive).
- Sediment chambers should be designed as level spreaders such that inflows to the filter bed have near zero velocity and spread runoff evenly across the bed.
- Non-structural and surface sand filters may use alternative pretreatment measures, such as a grass filter strip, forebay, gravel diaphragm, check dam, level spreader, or a combination of these. The grass filter strip must be a minimum length of 15 feet and have a slope of 3 percent or less. The check dam may be wooden or concrete and must be installed so that it extends only 2 inches above the filter strip and has lateral slots to allow runoff to be evenly distributed across the filter surface. Alternative pretreatment measures must contain a non-erosive flow path that distributes the flow evenly over the filter surface. If a forebay is used, it must be designed to accommodate at least 25 percent of the total design storm volume (inclusive).

### 3.7.4 Filtering Design Criteria

**Detention time.** All filter systems must be designed to drain the design storm volume from the filter chamber within 72 hours after each rainfall event.

**Structural Requirements.** If a filter will be located underground or experience traffic loads, a licensed structural engineer must certify the structural integrity of the design.

**Geometry.** Filters are gravity flow systems that normally require 2 to 5 feet of driving head to push the water through the filter media through the entire maintenance cycle; therefore, sufficient vertical clearance between the inverts of the inflow and outflow pipes is required.

**Type of Filter Media.** The normal filter media consists of clean, washed AASHTO M-6/ASTM C-33 medium aggregate concrete sand with individual grains between 0.02 and 0.04 inches in diameter.

**Depth of Filter Media.** The depth of the filter media plays a role in how quickly stormwater moves through the filter bed and how well it removes pollutants. The recommended filter bed depth is 18 inches. An absolute minimum filter bed depth of 12 inches above underdrains is required; although, designers should note that specifying the minimum depth of 12 inches will incur a more intensive maintenance schedule and possibly result in more costly maintenance.

**Underdrain and Liner.** Stormwater filters are normally designed with an impermeable liner and underdrain system that meet the criteria provided in Table 3.28 below.

**Underdrain Stone.** The underdrain should be covered by a minimum 6-inch gravel layer consisting of clean, washed No. 57 stone.

**Type of Filter.** There are several design variations of the basic filter that enable designers to use filters at challenging sites or to improve pollutant removal rates. The choice of which filter design to apply depends on available space, hydraulic head, and the level of pollutant removal desired. In ultra-urban situations where surface space is at a premium, underground sand filters are often the only design that can be used. Surface and perimeter filters are often a more economical choice when adequate surface area is available. The most common design variants include the following:

- **Non-Structural Sand Filter (F-1).** The non-structural sand filter is applied to sites less than 2 acres in size and is very similar to a bioretention practice (see Section 3.6 Bioretention), with the following exceptions:
  - ◆ The bottom is lined with an impermeable liner and always has an underdrain.
  - ◆ The surface cover is sand, turf, or pea gravel.
  - ◆ The filter media is 100 percent sand.
  - ◆ The filter surface is not planted with trees, shrubs, or herbaceous materials.
  - ◆ The filter has two cells, with a dry or wet sedimentation chamber preceding the sand filter bed.

The non-structural sand filter is the least expensive filter option for treating hotspot runoff. The use of bioretention areas is generally preferred at most other sites.

- **Surface Sand Filter (F-2).** The surface sand filter is designed with both the filter bed and sediment chamber located at ground level. The most common filter media is sand; however, a peat/sand mixture may be used to increase the removal efficiency of the system. In most cases, the filter chambers are created using precast or cast-in-place concrete. Surface sand filters are normally designed to be off-line facilities, so that only the desired design volume is

directed to the filter for treatment. However, in some cases they can be installed on the bottom of a Dry Extended Detention (ED) Pond (see Section 3.9 Open Channel Systems).

- **Underground Sand Filter.** The underground sand filter is modified to install the filtering components underground and is often designed with an internal flow splitter or overflow device that bypasses runoff from larger stormwater events around the filter. Underground sand filters are expensive to construct, but they consume very little space and are well suited to ultra-urban areas.
- **Three-Chamber Underground Sand Filter (F-3).** The three-chamber underground sand filter is a gravity flow system. The facility may be precast or cast-in-place. The first chamber acts as a pretreatment facility removing any floating organic material such as oil, grease, and tree leaves. It should have a submerged orifice leading to a second chamber, and it should be designed to minimize the energy of incoming stormwater before the flow enters the second chamber (i.e., filtering or processing chamber).

The second chamber is the filtering or processing chamber. It should contain the filter material consisting of gravel and sand and should be situated behind a weir. Along the bottom of the structure should be a subsurface drainage system consisting of a parallel perforated PVC pipe system in a stone bed. A dewatering valve should be installed at the top of the filter layer for safety release in cases of emergency. A bypass pipe crossing the second chamber to carry overflow from the first chamber to the third chamber is required.

The third chamber is the discharge chamber. It should also receive the overflow from the first chamber through the bypass pipe when the storage volume is exceeded.

Water enters the first chamber of the system by gravity or by pumping. This chamber removes most of the heavy solid particles, floatable trash, leaves, and hydrocarbons. Then the water flows to the second chamber and enters the filter layer by overtopping a weir. The filtered stormwater is then picked up by the subsurface drainage system that empties it into the third chamber.

Whenever there is insufficient hydraulic head for a three-chamber underground sand filter, a well pump may be used to discharge the effluent from the third chamber into the receiving storm or combined sewer. For three-chamber sand filters in combined-sewer areas, a water trap shall be provided in the third chamber to prevent the back flow of odorous gas.

- **Perimeter Sand Filter (F-74).** The perimeter sand filter also includes the basic design elements of a sediment chamber and a filter bed. The perimeter sand filter typically consists of two parallel trenches connected by a series of overflow weir notches at the top of the partitioning wall, which allows water to enter the second trench as sheet flow. The first trench is a pretreatment chamber removing heavy sediment particles and debris. The second trench consists of the sand filter layer. A subsurface drainage pipe must be installed at the bottom of the second chamber to facilitate the filtering process and convey filter water into a receiving system.

In this design, flow enters the system through grates, usually at the edge of a parking lot. The perimeter sand filter is usually designed as an on-line practice (i.e., all flows enter the system), but larger events bypass treatment by entering an overflow chamber. One major advantage of the perimeter sand filter design is that it requires little hydraulic head and is therefore a good option for sites with low topographic relief.

**Surface Cover.** The surface cover for non-structural and surface sand filters should consist of a 3-inch layer of topsoil on top of the sand layer. The surface may also have pea gravel inlets in the topsoil layer to promote filtration. The pea gravel may be located where sheet flow enters the filter, around the margins of the filter bed, or at locations in the middle of the filter bed.

Underground sand filters should have a pea gravel layer on top of the sand layer. The pea gravel helps to prevent bio-fouling or blinding of the sand surface.

**Maintenance Reduction Features.** The following maintenance issues should be addressed during filter design to reduce future maintenance problems:

- **Observation Wells and Cleanouts.** Non-structural and surface sand filters must include an observation well consisting of a 6-inch diameter non-perforated PVC pipe fitted with a lockable cap. It should be installed flush with the ground surface to facilitate periodic inspection and maintenance. In most cases, a cleanout pipe will be tied into the end of all underdrain pipe runs. The portion of the cleanout pipe/observation well in the underdrain layer should be perforated. At least one cleanout pipe must be provided for every 2000 square feet of filter surface area.
- **Access.** Good maintenance access is needed to allow crews to perform regular inspections and maintenance activities. —Sufficient access” is operationally defined as the ability to get a vacuum truck or similar equipment close enough to the sedimentation chamber and filter to enable cleanouts. Direct maintenance access shall be provided to the pre-treatment area and the filter bed. For underground structures, sufficient headroom for maintenance should be provided. A minimum head space of 5 feet above the filter is recommended for maintenance of the structure. However, if 5 feet headroom is not available, manhole access must be installed.
- **Manhole Access (for underground filters).** Access to the headbox and clearwell of Underground Filters must be provided by manholes at least 30 inches in diameter, along with steps to the areas where maintenance will occur.
- **Visibility.** Stormwater filters should be clearly visible at the site so inspectors and maintenance crews can easily find them. Adequate signs or markings must be provided at manhole access points for Underground Filters.
- **Confined Space Issues.** Underground filters are often classified as a confined space. Consequently, special OSHA rules apply, and training may be needed to protect the workers that access them. These procedures often involve training about confined space entry, venting, and the use of gas probes.

**Filter Material Specifications.** The basic material specifications for filtering practices that utilize sand as a filter media are outlined in Table 3.28.

**Table 3.28 Filtering Practice Material Specifications**

Material	Specification
Surface Cover	Non-structural and surface sand filters: 3-inch layer of topsoil on top of the sand layer. The surface may also have pea gravel inlets in the topsoil layer to promote filtration. Underground sand filters: Clean, washed No. 57 stone on top of the sand layer.
Sand	Clean AASHTO M-6/ASTM C-33 medium aggregate concrete sand with a particle size range of 0.02 to 0.04 inch in diameter.
Geotextile/Filter Fabric	An appropriate geotextile fabric that meets AASHTO M-288 Class 2, latest edition, requirements
Underdrain/Perforated Pipe	4- or 6-inch perforated schedule 40 PVC pipe, with 3/8-inch perforations at 6 inches on center.
Underdrain Stone	Use #57 stone or the ASTM equivalent (1 inch maximum).
Impermeable Liner	Where appropriate, use a thirty mil (minimum) PVC Geomembrane

Filter Sizing. Filtering devices are sized to accommodate a specified design storm volume (typically Stormwater Retention Volume (SWRv)). The volume to be treated by the device is a function of the storage depth above the filter and the surface area of the filter. The storage volume is the volume of ponding above the filter. For a given design volume, Equation 3.10 below is used to determine the required filter surface area.

**Equation 3.6 Minimum Filter Surface Area for Filtering Practices**

$$SA_{filter} = \frac{DesignVolume \times d_f}{k \times (h_{avg} + d_f) \times t_f}$$

where:

$SA_{filter}$	=	area of the filter surface (ft <sup>2</sup> )
$DesignVolume$	=	design storm volume, typically the SWRv (ft <sup>3</sup> )
$d_f$	=	filter media depth (thickness) (ft), with a minimum of 1 ft
$k$	=	coefficient of permeability (ft/day) (3.5 ft/day for partially clogged sand)
$h_f$	=	height of water above the filter bed (ft), with a maximum of 5 ft
$h_{avg}$	=	average height of water above the filter bed (ft), one half of the filter height (h f)
$t_f$	=	allowable drawdown time (1.67 days)

The coefficient of permeability (ft/day) is intended to reflect the worst case situation (i.e., the condition of the sand media at the point in its operational life where it is in need of replacement or maintenance). Filtering practices are therefore sized to function within the desired constraints at the end of the media's operational life cycle.

The entire filter treatment system, including pretreatment, shall temporarily hold at least 50 percent of the design storm volume prior to filtration (see Equation 3.7). This reduced volume takes into account the varying filtration rate of the water through the media, as a function of a gradually declining hydraulic head.

**Equation 3.7 Required Ponding Volume for Filtering Practices**

$$V_{ponding} = 0.50 \times DesignVolume$$

where:

$$\begin{aligned} V_{ponding} &= \text{storage volume required prior to filtration (ft}^3\text{)} \\ DesignVolume &= \text{design storm volume, typically the SWRv (ft}^2\text{)} \end{aligned}$$

The total storage volume for the practice (Sv) can be determined using Equation 3.8 below.

**Equation 3.8 Storage Volume for Filtering Practices**

$$Sv = 2.0 \times V_{ponding}$$

where:

$$\begin{aligned} Sv &= \text{XXX} \\ V_{ponding} &= \text{storage volume required prior to filtration (ft}^3\text{)} \end{aligned}$$

**3.7.5 Filtering Landscaping Criteria**

A dense and vigorous vegetative cover shall be established over the contributing pervious drainage areas before runoff can be accepted into the facility. Filtering practices should be incorporated into site landscaping to increase their aesthetics and public appeal.

Surface filters (e.g., surface and non-structural sand filters) can have a grass cover to aid in pollutant adsorption. The grass should be capable of withstanding frequent periods of inundation and drought.

**3.7.6 Filter Construction Sequence**

**Erosion and Sediment Control.** No runoff shall be allowed to enter the filter system prior to completion of all construction activities, including revegetation and final site stabilization. Construction runoff shall be treated in separate sedimentation basins and routed to bypass the filter system. Should construction runoff enter the filter system prior to final site stabilization, all contaminated materials must be removed and replaced with new clean filter materials before a regulatory inspector approves its completion. The approved erosion and sediment control plans shall include specific measures to provide for the protection of the filter system before the final stabilization of the site.

**Filter Installation.** The following is the typical construction sequence to properly install a structural sand filter. This sequence can be modified to reflect different filter designs, site conditions, and the size, complexity, and configuration of the proposed filtering application.

**Step 1: Stabilize Drainage Area.** Filtering practices should only be constructed after the contributing drainage area to the facility is completely stabilized, so sediment from the CDA does not flow into and clog the filter. If the proposed filtering area is used as a sediment trap or basin during the construction phase, the construction notes should clearly specify that, after site construction is complete, the sediment control facility will be dewatered, dredged, and regraded to design dimensions for the post-construction filter.

**Step 2: Install E&S Controls for the Filtering Practice.** Stormwater should be diverted around filtering practices as they are being constructed. This is usually not difficult to accomplish for off-line filtering practices. It is extremely important to keep runoff and eroded sediments away from the filter throughout the construction process. Silt fence or other sediment controls should be installed around the perimeter of the filter, and erosion control fabric may be needed during construction on exposed side-slopes with gradients exceeding 4H:1V. Exposed soils in the vicinity of the filtering practice should be rapidly stabilized by hydro-seed, sod, mulch, or other method.

**Step 3: Assemble Construction Materials onsite.** Make sure they meet design specifications and prepare any staging areas.

**Step 4: Clear and Strip Project Area** to the desired subgrade.

**Step 5: Excavate/Grade** until the appropriate elevation and desired contours are achieved for the bottom and side slopes of the filtering practice.

**Step 6: Install Filter Structure** and check all design elevations (i.e., concrete vaults for surface, underground, and perimeter sand filters). Upon completion of the filter structure shell, inlets and outlets must be temporarily plugged and the structure filled with water to the brim to demonstrate water tightness. Maximum allowable leakage is 5 percent of the water volume in a 24-hour period. If the structure fails the test, repairs must be performed to make the structure watertight before any sand is placed into it.

**Step 7: Install Gravel, Underdrains, and Choker Layer** of the filter.

**Step 8: Spread Sand Across Filter Bed** in 1-foot lifts up to the design elevation. Backhoes or other equipment can deliver the sand from outside the filter structure. Sand should be manually raked. Clean water is then added until the sedimentation chamber and filter bed are completely full. The facility is then allowed to drain, hydraulically compacting the sand layers. After 48 hours of drying, refill the structure to the final top elevation of the filter bed.

**Step 9: (Surface Sand Filters only)** Add a 3-inch topsoil layer and pea gravel inlets and immediately seed with the permanent grass species. The grass should be watered, and the facility should not be switched on-line until a vigorous grass cover has become established.

**Step 10: Stabilize Exposed Soils** on the perimeter of the structure with temporary seed mixtures appropriate for a buffer. All areas above the normal pool should be permanently stabilized by hydroseed, sod, or seeding and mulch.

**Step 11: Conduct Final Construction Inspection.** Multiple construction inspections by a qualified professional are critical to ensure that stormwater filters are properly constructed. Inspections are recommended during the following stages of construction:

- Initial site preparation, including installation \ Erosion and Sediment (E&S) controls;
- Excavation/grading to design dimensions and elevations;
- Installation of the filter structure, including the water tightness test;
- Installation of the underdrain and filter bed;
- Check that turf cover is vigorous enough to switch the facility on-line; and
- Final inspection after a rainfall event to ensure that it drains properly and all pipe connections are watertight. Develop a punch list for facility acceptance. Log the filtering practice’s GPS coordinates and submit them for entry into the BMP maintenance tracking database.

DDOE’s construction phase inspection checklist for filters can be found in Appendix L.

### 3.7.7 Filtering Maintenance Criteria

Maintenance of filters is required and involves several routine maintenance tasks, which are outlined in Table 3.29 below. A cleanup should be scheduled at least once a year to remove trash and floatables that accumulate in the pretreatment cells and filter bed. Frequent sediment cleanouts in the dry and wet sedimentation chambers are recommended every 1 to 3 years to maintain the function and performance of the filter. If the filter treats runoff from a stormwater hotspot, crews may need to test the filter bed media before disposing of the media and trapped pollutants. Petroleum hydrocarbon contaminated sand or filter cloth must be disposed of according to District solid waste disposal regulations. Testing is not needed if the filter does not receive runoff from a designated stormwater hotspot, in which case the media can be safely disposed of in a landfill.

**Table 3.29 Typical Annual Maintenance Activities for Filtering Practices**

Frequency	Maintenance Tasks
At least 4 times per growing season	<ul style="list-style-type: none"> <li>▪ Mow grass filter strips and perimeter turf around surface sand filters. Maximum grass heights should be less than 12 inches.</li> </ul>
2 times per year (may be more or less frequently depending on land use)	<ul style="list-style-type: none"> <li>▪ Check to see if sediment accumulation in the sedimentation chamber has exceeded 6 inches. If so, schedule a cleanout.</li> </ul>
Annually	<ul style="list-style-type: none"> <li>▪ Conduct inspection and cleanup</li> <li>▪ Dig a small test pit in the filter bed to determine whether the first 3 inches of sand are visibly discolored and need replacement.</li> <li>▪ Check to see if inlets and flow splitters are clear of debris and are operating properly.</li> <li>▪ Check concrete structures and outlets for any evidence of spalling, joint failure, leakage, corrosion, etc.</li> <li>▪ Ensure that the filter bed is level and remove trash and debris from the filter bed. Sand or gravel covers should be raked to a depth of 3 inches.</li> </ul>



Frequency	Maintenance Tasks
Every 5 years	<ul style="list-style-type: none"> <li>▪ Replace top sand layer.</li> <li>▪ Till or aerate surface to improve infiltration/grass cover</li> </ul>
As needed	<ul style="list-style-type: none"> <li>▪ Remove blockages and obstructions from inflows. Trash collected on the grates protecting the inlets shall be removed regularly to ensure the inflow capacity of the BMP is preserved.</li> <li>▪ Stabilize contributing drainage area and side-slopes to prevent erosion. Filters with a turf cover should have 95% vegetative cover.</li> </ul>
Upon failure	<ul style="list-style-type: none"> <li>▪ Corrective maintenance is required any time the sedimentation basin and sediment trap do not draw down completely after 72 hours (i.e., no standing water is allowed).</li> </ul>

**Maintenance Inspections.** Regular inspections by a qualified professional are critical to schedule sediment removal operations, replace filter media, and relieve any surface clogging. Frequent inspections are especially needed for underground and perimeter filters, since they are out of sight and can be easily forgotten. Depending on the level of traffic or the particular land use, a filter system may either become clogged within a few months of normal rainfall or could possibly last several years with only routine maintenance. Maintenance inspections should be conducted within 24 hours following a storm that exceeds 1/2 inch of rainfall, to evaluate the condition and performance of the filtering practice. Note: Without regular maintenance, reconditioning sand filters can be very expensive.

DDOE’s maintenance inspection checklists for filters can be found in Appendix M.

**Declaration of Covenants.** A maintenance covenant is required for all stormwater management practices. The covenant specifies the property owner’s primary maintenance responsibilities, and authorizes DDOE staff to access the property for inspection or corrective action in the event the proper maintenance is not performed. The covenant is attached to the deed of the property (see standard form, variations exist for scenarios where stormwater crosses property lines). The covenant is between the property and the District Government. It is submitted through the Office of the Attorney General. All SWMPs have a maintenance agreement stamp that must be signed for a building permit to proceed. There may be a maintenance schedule on the drawings themselves or the plans may refer to the maintenance schedule (schedule c in the covenant).

Covenants are not required on government properties but maintenance responsibilities must be defined through a partnership agreement or a memorandum of understanding.

**Waste Material.** Waste material from the repair, maintenance, or removal of a BMP or land cover shall be removed and disposed of in compliance with applicable federal and District law.

### 3.7.8 Filtering Volume Compliance Calculations

Filtering practices receive 0 percent retention value and are an accepted TSS removal practice for the amount of storage volume (Sv) provided by the practice (Table 3.30).

**Table 3.30 Filter Retention Value and Pollutant Removal**

Retention Value	= 0
Accepted TSS Treatment Practice	Yes

The practice must be sized using the guidance detailed in Section 3.7.4.

### **3.7.9 References**

Atlanta Regional Commission (ARC). 2001. Georgia Stormwater Management Manual, First Edition. Available online at: <http://www.georgiastormwater.com>

Claytor, R. and T. Schueler. 1996. Design of Stormwater Filtering Systems. Chesapeake Research Consortium and the Center for Watershed Protection. Ellicott City, MD. <http://www.cwp.org/online-watershed-library?view=docman>

Virginia DCR Stormwater Design Specification No. 12: Filtering Practices Version 1.7. 2010.

### 3.8 Stormwater Infiltration

**Definition.** Practices that capture and temporarily store the design storm volume before allowing it to infiltrate into the soil over a two day period. Design variants include:

I-1 Infiltration Trench

I-2 Infiltration Basin

Infiltration practices use temporary surface or underground storage to allow incoming stormwater runoff to exfiltrate into underlying soils. Runoff first passes through multiple pretreatment mechanisms to trap sediment and organic matter before it reaches the practice. As the stormwater penetrates the underlying soil, chemical and physical adsorption processes remove pollutants. Infiltration practices are suitable for use in residential and other urban areas where field measured soil infiltration rates are sufficient. To prevent possible groundwater contamination, infiltration must not be utilized at sites designated as stormwater hotspots.

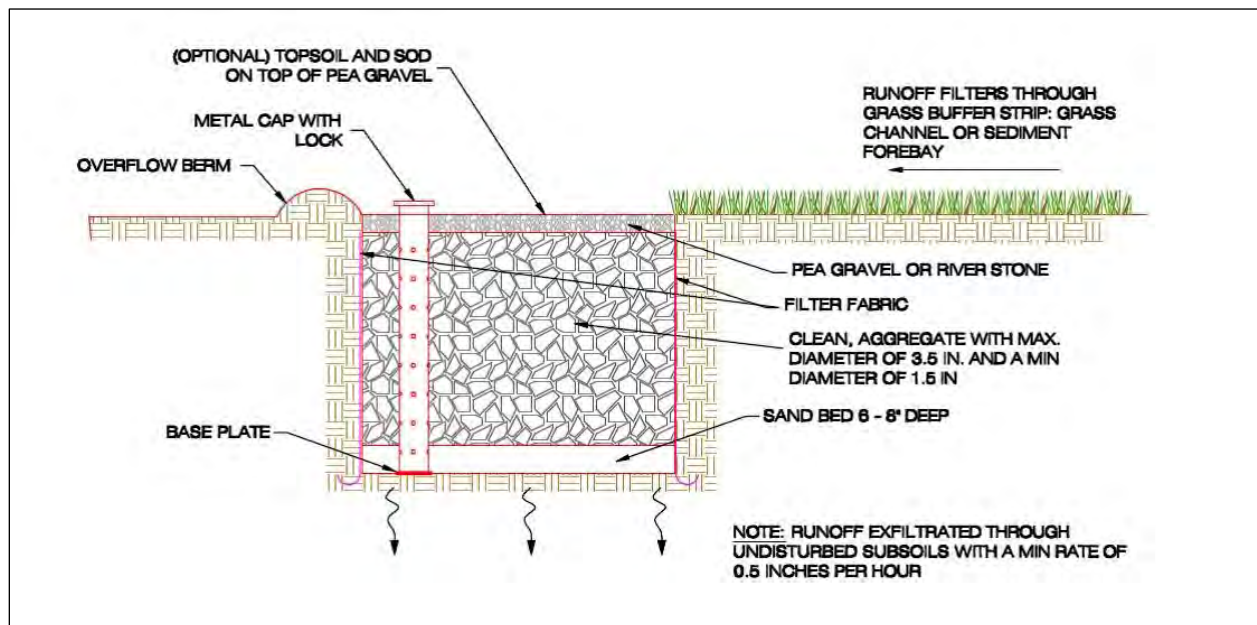


Figure 3.29 Example of an infiltration trench.

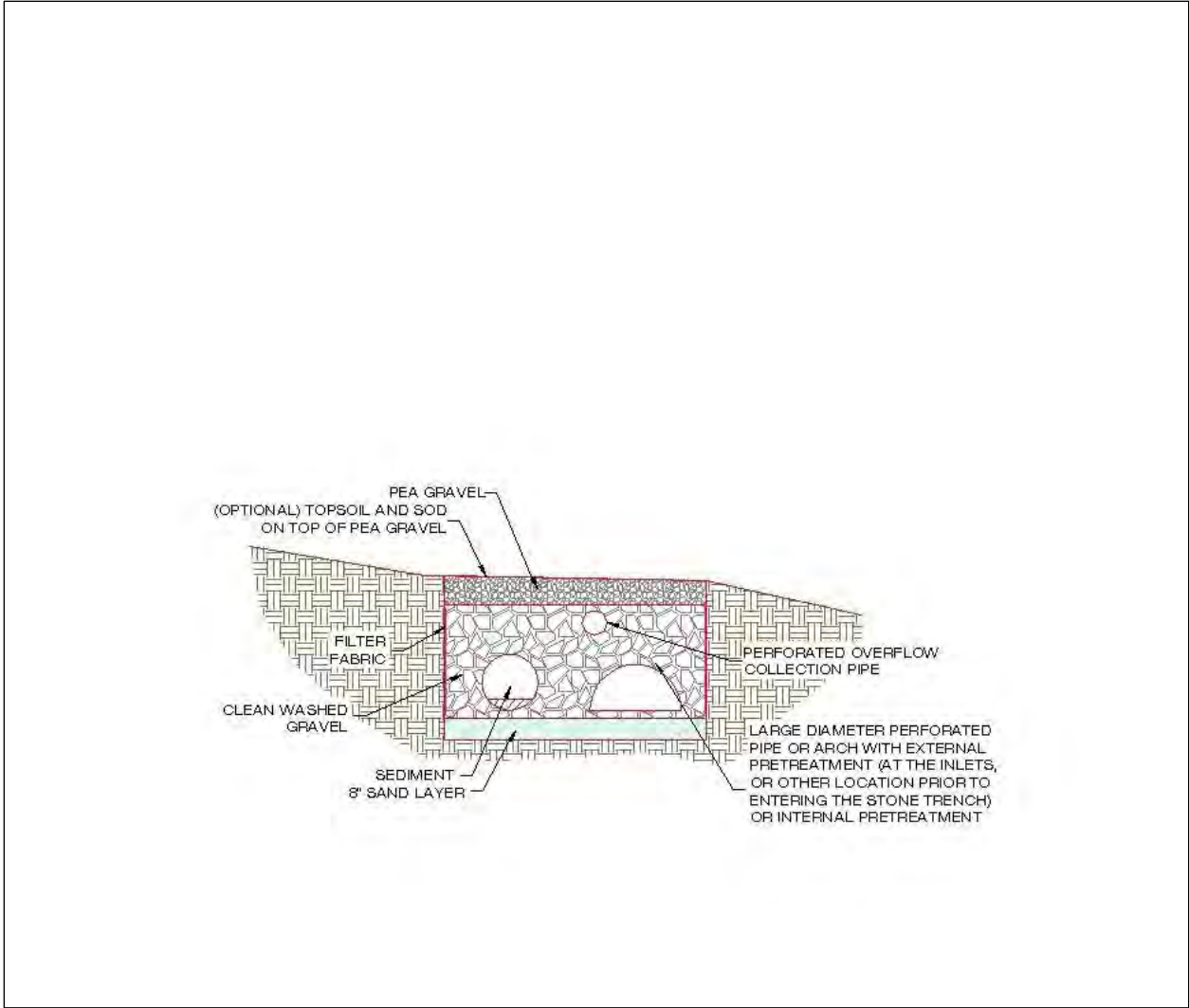


Figure 3.30 Infiltration section with supplemental pipe storage.

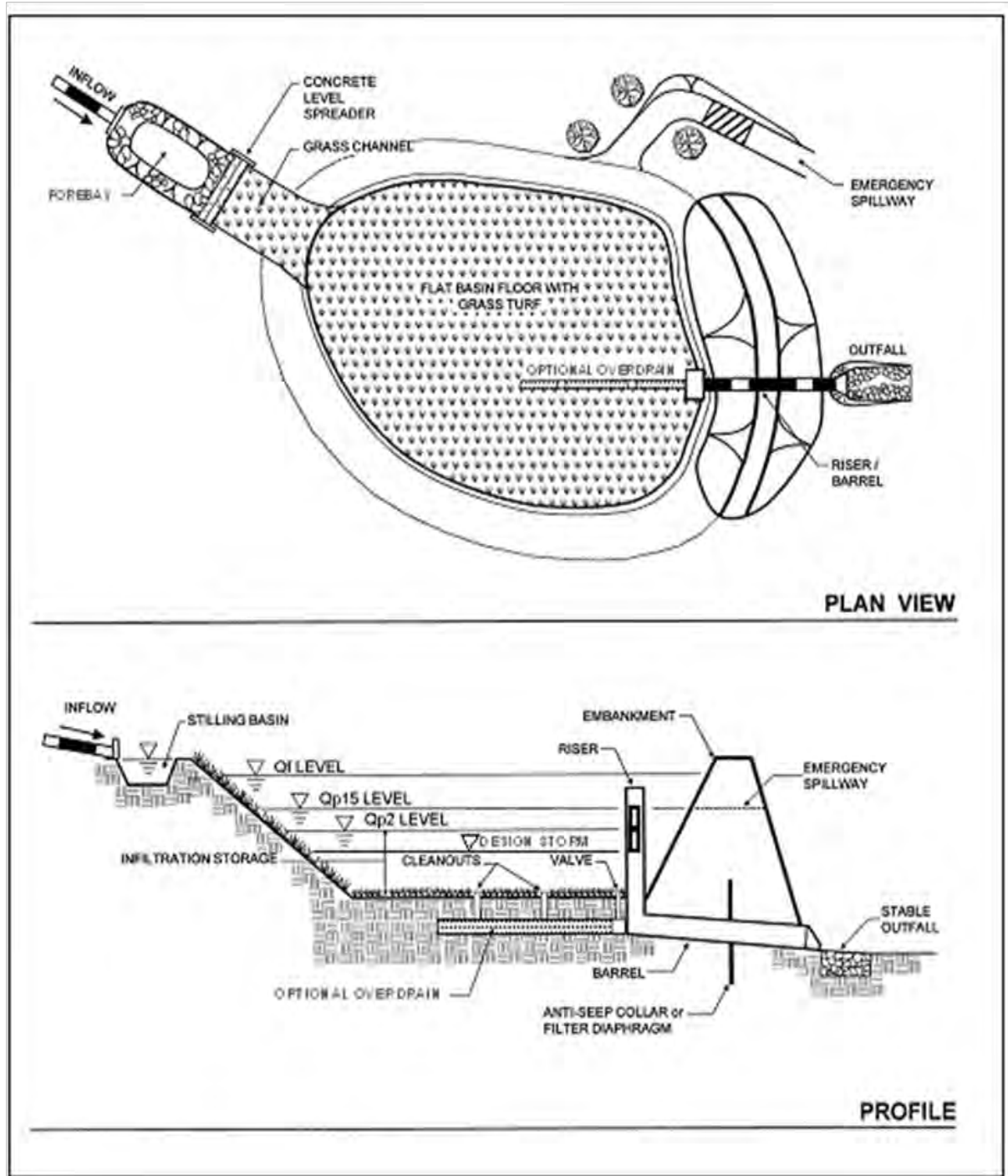


Figure 3.31 Example of an infiltration basin.

### 3.8.1 Infiltration Feasibility Criteria

Infiltration practices have very high storage and retention capabilities when sited and designed appropriately. Designers should evaluate the range of soil properties during initial site layout and seek to configure the site to conserve and protect the soils with the greatest recharge and

infiltration rates. In particular, areas of Hydrologic Soil Group A or B soils, shown on the U.S. Department of Agriculture's Natural Resources Conservation Service (NRCS) soil surveys, should be considered as primary locations for infiltration practices. Additional information about soil and infiltration are described in more detail later in this section. During initial design phases, designers should carefully identify and evaluate constraints on infiltration, as follows:

**Underground Injection Control for Class V Wells.** In order for an infiltration practice to avoid classification as a Class V well, which is subject regulation under the Federal Underground Injection Control (UIC) program, the practice must be wider than the practice is deep. If an infiltration practice is “deeper than its widest surface dimension” or if it includes an underground distribution system, then it will likely be considered a Class V injection well. Class V injection wells are subject to permit approval by the U.S. Environmental Protection Agency (EPA). For more information on Class V injection wells and stormwater management, designers should consult [http://water.epa.gov/type/groundwater/uic/class5/comply\\_minrequirements.cfm](http://water.epa.gov/type/groundwater/uic/class5/comply_minrequirements.cfm) for EPA's minimum requirements.

**Contributing Drainage Area.** The maximum Contributing Drainage Area (CDA) to an individual infiltration practice should be less than 2 acres and as close to 100 percent impervious as possible. The design, pretreatment, and maintenance requirements will differ depending on the size of the infiltration practice.

**Site Topography.** Infiltration shall not be located on slopes greater than 6 percent, although check dams or other devices may be employed to reduce the effective slope of the practice. Further, unless slope stability calculations demonstrate otherwise, infiltration practices should be located a minimum horizontal distance of 200 feet from down-gradient slopes greater than 20 percent.

**Minimum Hydraulic Head.** Two or more feet of head may be needed to promote flow through infiltration practices.

**Minimum Depth to Water Table or Bedrock.** A minimum vertical distance of 2 feet must be provided between the bottom of the infiltration practice and the seasonal high water table or bedrock layer.

**Soils.** Initially, soil infiltration rates can be estimated from NRCS soil data, but designers must verify soil permeability by using the on-site soil investigation methods provided in Appendix P.

**Use on Urban Fill Soils/Redevelopment Sites.** Sites that have been previously graded or disturbed do not typically retain their original soil permeability due to compaction. Therefore, such sites are often not good candidates for infiltration practices unless the geotechnical investigation shows that a sufficient infiltration rate exists.

**Dry Weather Flows.** Infiltration practices should not be used on sites receiving regular dry-weather flows from sump pumps, irrigation water, chlorinated wash-water, or other non-stormwater flows.

**Setbacks.** Infiltration practices must not be hydraulically connected to structure foundations or pavement, in order to avoid harmful seepage. Setbacks to structures vary must be at least 10 feet

and adequate water-proofing protection must be provided for foundations and basements. Where the 10-foot setback is not possible, an impermeable liner may be used along the sides of the infiltration area (extending from the surface to the bottom of the practice).

All setbacks must be verified by a professional geotechnical engineer registered in the District of Columbia.

**Proximity to Utilities.** Interference with underground utilities should be avoided, if possible. When large site development is undertaken the expectation of achieving avoidance will be high. Conflicts may be commonplace on smaller sites and in the public right-of-way. Consult with each utility company on recommended offsets, which will allow utility maintenance work with minimal disturbance to the infiltration BMP. For an infiltration BMP in the public right-of-way a consolidated presentation of the various utility offset recommendations can be found in Chapter 33.14.5 of the District of Columbia Department of Transportation Design and Engineering Manual, latest edition. Consult the District of Columbia Water and Sewer Authority Green Infrastructure Utility Protection Guidelines, latest edition, for water and sewer line recommendations. Where conflicts cannot be avoided, follow these guidelines:

- Consider altering the location or sizing of the infiltration BMP to avoid or minimize the utility conflict. Consider an alternate BMP type to avoid conflict.
- Use design features to mitigate the impacts of conflicts that may arise by allowing the infiltration BMP and the utility to co-exist. The infiltration BMP design may need to incorporate impervious areas, through geotextiles or compaction, to protect utility crossings. Other a key design feature may need to be moved or added or deleted
- Work with the utility to evaluate the relocation of the existing utility and install the optimum placement and sizing of the infiltration BMP.
- If utility functionality, longevity and vehicular access to manholes can be assured accept the infiltration BMP design and location with the existing utility. Incorporate into the infiltration BMP design sufficient soil coverage over the utility or general clearances or other features such as an impermeable linear to assure all entities the conflict is limited to maintenance.

Note: When accepting utility conflict into the infiltration BMP location and design, it is understood the infiltration BMP will be temporarily impacted during utility work but the utility will replace the infiltration BMP or, alternatively, install a functionally comparable infiltration BMP according to the specifications in the current version of this Stormwater Management Guidebook. If the infiltration BMP is located in the public right-of-way the infiltration BMP restoration will also conform with the District of Columbia Department of Transportation Design and Engineering Manual with special attention to Chapter 33, Chapter 47 and the Design and Engineering Manual supplements for Low Impact Development and Green Infrastructure Standards and Specifications.

**Hotspots and High Loading Situations.** Infiltration practices are not intended to treat sites with high sediment or trash or debris loads, because such loads will cause the practice to clog and fail. Infiltration practices must be avoided at potential stormwater hotspots that pose a risk of groundwater contamination. For a list of potential stormwater hotspot operations, consult Appendix Q.

On sites with existing contaminated soils, as indicated in Appendix P, infiltration is not allowed.

### 3.8.2 Infiltration Conveyance Criteria

The nature of the conveyance and overflow to an infiltration practice depends on the scale of infiltration and whether the facility is on-line or off-line. Where possible, conventional infiltration practices should be designed off-line to avoid damage from the erosive velocities of larger design storms. If runoff is delivered by a storm drain pipe or along the main conveyance system, the infiltration practice shall be designed as an off-line practice. Pretreatment shall be provided for storm drain pipes systems discharging directly to infiltration systems.

**Off-line Infiltration.** Overflows can either be diverted from entering the infiltration practice or dealt with via an overflow inlet. Optional overflow methods include the following:

- Utilize a low-flow diversion or flow splitter at the inlet to allow only the design stormwater retention volume (SWRv) to enter the facility. This may be achieved with a weir or curb opening sized for the target flow, in combination with a bypass channel. Using a weir or curb opening helps minimize clogging and reduces the maintenance frequency (further guidance on determining the peak flow rate will be necessary in order to ensure proper design of the diversion structure).
- Use landscaping type inlets or standpipes with trash guards as overflow devices.

**On-line Infiltration.** An overflow structure must be incorporated into on-line designs to safely convey larger storms through the infiltration area. The following criteria apply to overflow structures:

- An overflow mechanism such as an elevated drop inlet or overflow weir should be used to direct high flows to a non-erosive down-slope overflow channel, stabilized water course, or storm sewer system designed to convey the 15-year design storm.

### 3.8.3 Infiltration Pretreatment Criteria

Every infiltration system shall have pretreatment mechanisms to protect the long term integrity of the infiltration rate. One of the following techniques must be installed to pretreat 100 percent of the inflow in every facility:

- Grass channel
- Grass filter strip (minimum 20 feet and only if sheet flow is established and maintained)
- Forebay (must accommodate a minimum 25 percent of the design storm volume; if the infiltration rate for the underlying soils is greater than 2 inches per hour, the forebay volume shall be increased to a minimum of 50 percent of the design storm volume)
- Gravel diaphragm (minimum 1 foot deep and 2 feet wide and only if sheet flow is established and maintained)
- Filter system (see Section 3.7 Stormwater Filtering Systems) If using a filter system as a pretreatment facility, the sand filter will not require its own separate pretreatment facility.



- A proprietary structure with demonstrated capability of reducing sediment and hydrocarbons may be used to provide pre-treatment. Refer to Section 3.13 Proprietary Practices and Appendix T for information on approved proprietary structures.

If the basin serves a CDA greater than 20,000 square feet, a forebay, filter system, or proprietary practice must be used for pretreatment.

Exit velocities from the pretreatment chamber shall not be erosive (above 6 fps) during the 15-year design storm and flow from the pretreatment chamber should be evenly distributed across the width of the practice (e.g., using a level spreader).

### 3.8.4 Infiltration Design Criteria

**Geometry.** Where possible, infiltration practices should be designed to be wider than they are deep, to avoid classification as a class V injection well. For more information on Class V wells see <http://water.epa.gov/type/groundwater/uic/class5/index.cfm>.

**Practice Slope.** The bottom of an infiltration practice should be flat (i.e., 0 percent longitudinal and lateral slopes) to enable even distribution and infiltration of stormwater.

**Infiltration Basin Geometry.** The maximum vertical depth to which runoff may be ponded over an infiltration basin is 24 inches. The side-slopes should be no steeper than 4H:1V

**Surface Cover (optional).** Designers may choose to install a layer of topsoil and grass above the infiltration practice.

**Surface Stone.** A 3-inch layer of clean, washed river stone or No. 8 or 89 stone should be installed over the stone layer.

**Stone Layer.** Stone layers must consist of clean, washed aggregate with a maximum diameter of 3.5 inches and a minimum diameter of 1.5 inches.

**Underground Storage (optional).** In the underground mode, runoff is stored in the voids of the stones and infiltrates into the underlying soil matrix. Perforated corrugated metal pipe, plastic pipe, concrete arch pipe, or comparable materials can be used in conjunction with the stone to increase the available temporary underground storage. In some instances, a combination of filtration and infiltration cells can be installed in the floor of a dry extended detention (ED) pond.

**Overflow Collection Pipe (Overdrain).** An optional overflow collection pipe can be installed in the stone layer to convey collected runoff from larger storm events to a downstream conveyance system.

**Trench Bottom.** To protect the bottom of an infiltration trench from intrusion by underlying soils, a sand layer must be used. The underlying native soils must be separated from the stone layer by a 6- to 8-inch layer of coarse sand (e.g., ASTM C 33, 0.02-0.04 inch).

**Geotextile Fabric.** An appropriate geotextile fabric that complies with AASHTO M-288 Class 2, latest edition, requirements and has a permeability of at least an order of magnitude higher

(10x) than the soil subgrade permeability must be used. This layer should be applied only to the sides of the practice.

**Material Specifications.** Recommended material specifications for infiltration areas are shown in Table 3.31.

**Table 3.31 Infiltration Material Specifications**

Material	Specification	Notes
Surface Layer (optional)	Topsoil and grass layer	
Surface Stone	Install a 3-inch layer of river stone or pea gravel.	Provides an attractive surface cover that can suppress weed growth.
Stone Layer	Clean, aggregate with a maximum diameter of 3.5 inches and a minimum diameter of 1.5 inches.	
Observation Well	Install a vertical 6-inch Schedule 40 PVC perforated pipe, with a lockable cap and anchor plate.	Install one per 50 feet of length of infiltration practice.
Overflow Collection Pipe (optional)	Use 4- or 6-inch rigid schedule 40 PVC pipe, with 3/8-inch perforations at 6 inches on center.	
Trench Bottom	Install a 6- to 8-inch sand layer (e.g., ASTM C 33, 0.02-0.04 inch)	
Geotextile Fabric (sides only)	An appropriate geotextile fabric that complies with AASHTO M-288 Class 2, latest edition, requirements and has a permeability of at least an order of magnitude higher (10x) than the soil subgrade permeability must be used.	

**Practice Sizing.** The proper approach for designing infiltration practices is to avoid forcing a large amount of infiltration into a small area. Therefore, individual infiltration practices that are limited in size due to soil permeability and available space need not be sized to achieve the full design storm volume (SWR<sub>v</sub>) for the contributing drainage area, as long as other stormwater treatment practices are applied at the site to meet the remainder of the design storm volume.

Several equations (see following page) are needed to size infiltration practices. The first equations establish the maximum depth of the infiltration practice, depending on whether it is a surface basin (Equation 3.9) or trench with an underground reservoir (Equation 3.10).

**Equation 3.9 Maximum Surface Basin Depth for Infiltration Basins**

$$d_{\max} = \frac{i}{2} \times t_d$$

**Equation 3.10 Maximum Underground Reservoir Depth for Infiltration Trenches**

$$d_{\max} = \frac{\left(\frac{i}{2} \times t_d\right)}{\eta_r}$$

where:

- $d_{max}$  = maximum depth of the infiltration practice (ft)  
 $i$  = field-verified (actual) infiltration rate for the native soils (ft/day)  
 $t_d$  = maximum drawdown time (day) (normally 3 days)  
 $\eta_r$  = available porosity of the stone reservoir (assume 0.35)

These equations make the following design assumptions:

- **Conservative Infiltration Rates.** For design purposes, the field-tested subgrade soil infiltration rate ( $i$ ) is divided by 2 as a factor of safety to account for potential compaction during construction and to approximate long term infiltration rates. On-site infiltration investigations must be conducted to establish the actual infiltration capacity of underlying soils, using the methods presented in Appendix P.
- **Stone Layer Porosity.** A porosity value of 0.35 shall be used in the design of stone reservoirs, although a larger value may be used if perforated corrugated metal pipe, plastic pipe, concrete arch pipe, or comparable materials are installed within the reservoir.
- **Rapid Drawdown.** Infiltration practices must be sized so that the design volume infiltrates within 72 hours, to prevent nuisance ponding conditions.

Designers should compare these results to the maximum allowable depths in Table 3.32 and use whichever value is less for subsequent design.

**Table 3.32 Maximum Facility Depth for Infiltration Practices**

Mode of Entry	Scale of Infiltration		
	Micro Infiltration (250–2,500 ft <sup>2</sup> )	Small Scale Infiltration (2,500–20,000 ft <sup>2</sup> )	Conventional Infiltration (20,000–100,000 ft <sup>2</sup> )
Surface Basin	1.0	1.5	2.0
Underground Reservoir	3.0	5.0	varies

Once the maximum depth is known, calculate the surface area needed for an infiltration practice using Equation 3.11 or Equation 3.12.

**Equation 3.11 Surface Basin Surface Area for Infiltration Basins**

$$SA = \frac{DesignStorm}{d + \left(\frac{i}{2} \times t_f\right)}$$

**Equation 3.12 Underground Reservoir Surface Area for Infiltration Trenches**

$$SA = \frac{DesignStorm}{(\eta_r \times d) + (0.5 \times i \times t_f)}$$

where:

$SA$	=	surface area (ft <sup>2</sup> )
$DesignStorm$	=	$SWRv$ or other design storm volume (ft <sup>3</sup> ) (e.g., portion of the $SWRv$ )
$\eta_r$	=	available porosity of the stone reservoir (assume 0.35)
$d$	=	infiltration depth (ft) (maximum depends on the scale of infiltration and the results of Equation 3.9 or 3.10)
$i$	=	field-verified (actual) infiltration rate for the native soils (ft/day)
$t_f$	=	time to fill the infiltration facility (days) (typically 2 hours, or 0.083 days)

The storage volume ( $S_v$ ) captured by the infiltration practice is defined as the volume of water that is fully infiltrated through the practice (no overflow). Designers may choose to infiltrate less than the full design storm ( $SWRv$ ). In this case, the design volume captured must be treated as the storage volume,  $S_v$  of the practice (see Section 3.8.8 Infiltration Stormwater Compliance Calculations).  $S_v$  can be determined by rearranging Equation 3.11 and Equation 3.12 to yield Equation 3.13 and Equation 3.15.

**Equation 3.13 Storage Volume Calculation for Surface Basin Area for Infiltration Basins**

$$S_v = SA \times \left[ d + \left( \frac{i}{2} \times t_f \right) \right]$$

**Equation 3.14 Storage Volume Calculation for Underground Reservoir Surface Area for Infiltration Trenches**

$$S_v = SA \times \left[ (\eta_r \times d) + \left( \frac{i}{2} \times t_f \right) \right]$$

Infiltration practices can also be designed to address, in whole or in part, the detention storage needed to comply with channel protection and/or flood control requirements. The designer can model various approaches by factoring in storage within the stone aggregate layer, any perforated corrugated metal pipe, plastic pipe, concrete arch pipe, or comparable materials installed within the reservoir, expected infiltration, and any outlet structures used as part of the design. Routing calculations can also be used to provide a more accurate solution of the peak discharge and required storage volume.

### 3.8.5 Infiltration Landscaping Criteria

Infiltration trenches can be effectively integrated into the site plan and aesthetically designed with adjacent native landscaping or turf cover, subject to the following additional design considerations:

- Infiltration practices should not be installed until all up-gradient construction is completed and pervious areas are stabilized with dense and healthy vegetation, unless the practice can be kept off-line so it receives no runoff until construction and stabilization is complete.
- Vegetation associated with the infiltration practice buffers should be regularly maintained to limit organic matter in the infiltration device and maintain enough vegetation to prevent soil erosion from occurring.

### 3.8.6 Infiltration Construction Sequence

Infiltration practices are particularly vulnerable to failure during the construction phase for two reasons. First, if the construction sequence is not followed correctly, construction sediment can clog the practice. In addition, heavy construction can result in compaction of the soil, which can then reduce the soil's infiltration rate. For this reason, a careful construction sequence needs to be followed.

During site construction, the following steps are absolutely critical:

**Step 1:** Avoid excessive compaction by preventing construction equipment and vehicles from traveling over the proposed location of the infiltration practice. When this is unavoidable, the impacted area cannot be excavated below 2 feet above the final design elevation of the bottom of the practice until further compaction by heavy equipment can be avoided. Once the area is excavated to grade, impacted area must be tilled a minimum of 12 inches (30 cm) below the bottom of the infiltration practice.

Any area of the site intended ultimately to be an infiltration practice should generally not be used as the site of a temporary sediment basin. Where locating a sediment basin on an area intended for infiltration is unavoidable, the invert of the sediment basin must be a minimum of 2 feet above the final design elevation of the bottom of the proposed infiltration practice. All sediment deposits in the excavated area should be carefully removed prior to installing the infiltration practice.

**Step 2:** Keep the infiltration practice "off-line" until construction is complete. Prevent sediment from entering the infiltration site by using super silt fence, diversion berms, or other means. In the erosion and sediment control plan, indicate the earliest time at which stormwater runoff may be directed to a conventional infiltration basin. The erosion and sediment control plan must also indicate the specific methods to be used to temporarily keep runoff from the infiltration site.

**Step 3:** Upland drainage areas need to be completely stabilized with a thick layer of vegetation prior to commencing excavation for an infiltration practice.

**Infiltration Installation.** The actual installation of an infiltration practice is done using the following steps:

**Step 1:** Excavate the infiltration practice to the design dimensions from the side using a backhoe or excavator. The floor of the pit should be completely level, but equipment should be kept off the floor area to prevent soil compaction.

**Step 2:** Install geotextile fabric on the trench sides. Large tree roots should be trimmed flush with the sides of infiltration trenches to prevent puncturing or tearing of the geotextile fabric during subsequent installation procedures. When laying out the geotextile, the width should include sufficient material to compensate for perimeter irregularities in the trench and for a 6-inch minimum overlap at the top of the trench. The geotextile fabric itself should be tucked under the sand layer on the bottom of the infiltration trench. Stones or other anchoring objects should be placed on the fabric at the trench sides, to keep the trench open during windy periods. Voids may occur between the fabric and the excavated sides of a trench. Natural soils should be placed in all voids, to ensure the fabric conforms smoothly to the sides of excavation.

**Step 3:** Scarify the bottom of the infiltration practice, and spread 6 inches of sand on the bottom as a filter layer.

**Step 4:** Anchor the observation well(s) and add stone to the practice in 1-foot lifts.

**Step 5:** Use sod, where applicable, to establish a dense turf cover for at least 10 feet around the sides of the infiltration practice, to reduce erosion and sloughing.

**Construction Supervision.** Supervision during construction is recommended to ensure that the infiltration practice is built in accordance with the approved design and this specification. Qualified individuals should use detailed inspection checklists to include sign-offs at critical stages of construction, to ensure that the contractor's interpretation of the plan is consistent with the designer's intentions.

DDOE's construction phase inspection checklist for infiltration practices can be found in Appendix L.

### 3.8.7 Infiltration Maintenance Criteria

Maintenance is a crucial and required element that ensures the long-term performance of infiltration practices. The most frequently cited maintenance problem for infiltration practices is clogging of the stone by organic matter and sediment. The following design features can minimize the risk of clogging:

**Stabilized CDA.** Infiltration systems may not receive runoff until the entire contributing drainage area has been completely stabilized.

**Observation Well.** Infiltration practices must include an observation well, consisting of an anchored 6-inch diameter perforated PVC pipe fitted with a lockable cap installed flush with the ground surface, to facilitate periodic inspection and maintenance.

**No Geotextile Fabric on Bottom.** Avoid installing geotextile fabric along the bottom of infiltration practices. Experience has shown that geotextile fabric is prone to clogging. However, permeable geotextile fabric should be installed on the trench sides to prevent soil piping.

**Direct Maintenance Access.** Access must be provided to allow personnel and heavy equipment to perform non-routine maintenance tasks, such as practice reconstruction or rehabilitation. While a turf cover is permissible for small-scale infiltration practices, the surface must never be covered by an impermeable material, such as asphalt or concrete.

**Maintenance Inspections.** Effective long-term operation of infiltration practices requires a dedicated and routine maintenance inspection schedule with clear guidelines and schedules, as shown in Table 3.33 below. Where possible, facility maintenance should be integrated into routine landscaping maintenance tasks.

**Table 3.33 Typical Maintenance Activities for Infiltration Practices**

Schedule	Maintenance Activity
Quarterly	<ul style="list-style-type: none"> <li>▪ Ensure that the contributing drainage area, inlets, and facility surface are clear of debris.</li> <li>▪ Ensure that the contributing drainage area is stabilized. Perform spot-reseeding if where needed.</li> <li>▪ Remove sediment and oil/grease from inlets, pre-treatment devices, flow diversion structures, and overflow structures.</li> <li>▪ Repair undercut and eroded areas at inflow and outflow structures.</li> </ul>
Semi-annual inspection	<ul style="list-style-type: none"> <li>▪ Check observation wells 3 days after a storm event in excess of 1/2 inch in depth. Standing water observed in the well after three days is a clear indication of clogging.</li> <li>▪ Inspect pre-treatment devices and diversion structures for sediment build-up and structural damage.</li> </ul>
Annually	<ul style="list-style-type: none"> <li>▪ Clean out accumulated sediments from the pre-treatment cell.</li> </ul>
As needed	<ul style="list-style-type: none"> <li>▪ Replace pea gravel/topsoil and top surface geotextile fabric (when clogged).</li> <li>▪ Mow vegetated filter strips as necessary and remove the clippings.</li> </ul>

It is highly recommended that a qualified professional conduct annual site inspections for infiltration practices to ensure the practice performance and longevity of infiltration practices.

DDOE’s maintenance inspection checklist for infiltration systems can be found in Appendix M.

**Declaration of Covenants.** A declaration of covenants that includes all maintenance responsibilities to ensure the continued stormwater performance for the BMP is required. The declaration of covenants specifies the property owner’s primary maintenance responsibilities, and authorizes DDOE staff to access the property for inspection or corrective action in the event the proper maintenance is not performed. The declaration of covenants is attached to the deed of the property. An example form is provided at the end of Chapter 5 though variations will exist for scenarios where stormwater crosses property lines. The covenant is between the property and the District Government. It is submitted through the Office of the Attorney General (OAG). All SWMPs have a maintenance agreement stamp that must be signed for a building permit to proceed. A maintenance schedule must appear on the SWMP. Additionally, a maintenance schedule is required in schedule c of the declaration of covenants.

Covenants are not required on government properties, but maintenance responsibilities must be defined through a partnership agreement or a memorandum of understanding.

**Waste Material.** Waste material from the repair, maintenance, or removal of a BMP or land cover shall be removed and disposed of in compliance with applicable federal and District law.

### 3.8.8 Infiltration Stormwater Compliance Calculations

Infiltration practices receive 100 percent retention value for the amount of storage volume (Sv) provided by the practice (Table 3.34). Since the practice gets 100 percent retention value, it is not considered an accepted TSS treatment practice.

**Table 3.34 Infiltration Retention Value and Pollutant Removal**

Retention Value	= Sv
Accepted TSS Treatment Practice	N/A

The practice must be sized using the guidance detailed in Section 3.8.4. Infiltration Design Criteria.

Infiltration practices also contribute to peak flow reduction. This contribution can be determined in several ways. One method is to subtract the Sv or Retention Value from the total runoff volume for the 2-year, 15-year, and 100-year storms. The resulting reduced runoff volumes can then be used to calculate a Reduced Natural Resource Conservation Service (NRCS) Curve Number for the site or drainage area. The Reduced Curve Number can then be used to calculate peak flow rates for the various storm events. Other hydrologic modeling tools that employ different procedures may be used as well.

### 3.8.9 References

Virginia DCR Stormwater Design Specification No. 8: Bioretention Version 1.8. 2010.



### 3.9 Open Channel Systems

**Definition.** Vegetated open channels that are designed to capture and treat or convey the design storm volume (Stormwater Retention Volume (SWRv)). Design variants include:

- O-1 Grass channels
- O-2 Dry swales/bioswales
- O-3 Wet swales

Open channel systems shall not be designed to provide stormwater detention except under extremely unusual conditions. Open channel systems must generally be combined with a separate facility to meet these requirements.

**Grass channels (O-1)** can provide a modest amount of runoff filtering and volume attenuation within the stormwater conveyance system resulting in the delivery of less runoff and pollutants than a traditional system of curb and gutter, storm drain inlets, and pipes. The performance of grass channels will vary depending on the underlying soil permeability. Grass channels, however, are not capable of providing the same stormwater functions as dry swales as they lack the storage volume associated with the engineered soil media. Their retention performance can be boosted when compost amendments are added to the bottom of the swale (see Appendix K). Grass channels are a preferable alternative to both curb and gutter and storm drains as a stormwater conveyance system, where development density, topography, and soils permit.

**Dry swales (O-2)**, also known as bioswales, are essentially bioretention cells that are shallower, configured as linear channels, and covered with turf or other surface material (other than mulch and ornamental plants). The dry swale is a soil filter system that temporarily stores and then filters the desired design storm volume. Dry swales rely on a pre-mixed soil media filter below the channel that is similar to that used for bioretention. If soils are extremely permeable, runoff infiltrates into underlying soils. In most cases, however, the runoff treated by the soil media flows into an underdrain, which conveys treated runoff back to the conveyance system further downstream. The underdrain system consists of a perforated pipe within a gravel layer on the bottom of the swale, beneath the filter media. Dry swales may appear as simple grass channels with the same shape and turf cover, while others may have more elaborate landscaping. Swales can be planted with turf grass, tall meadow grasses, decorative herbaceous cover, or trees.

**Wet swales (O-3)** can provide a modest amount of runoff filtering within the conveyance. These linear wetland cells often intercept shallow groundwater to maintain a wetland plant community. The saturated soil and wetland vegetation provide an ideal environment for gravitational settling, biological uptake, and microbial activity. On-line or off-line cells are formed within the channel to create saturated soil or shallow standing water conditions (typically less than 6 inches deep).

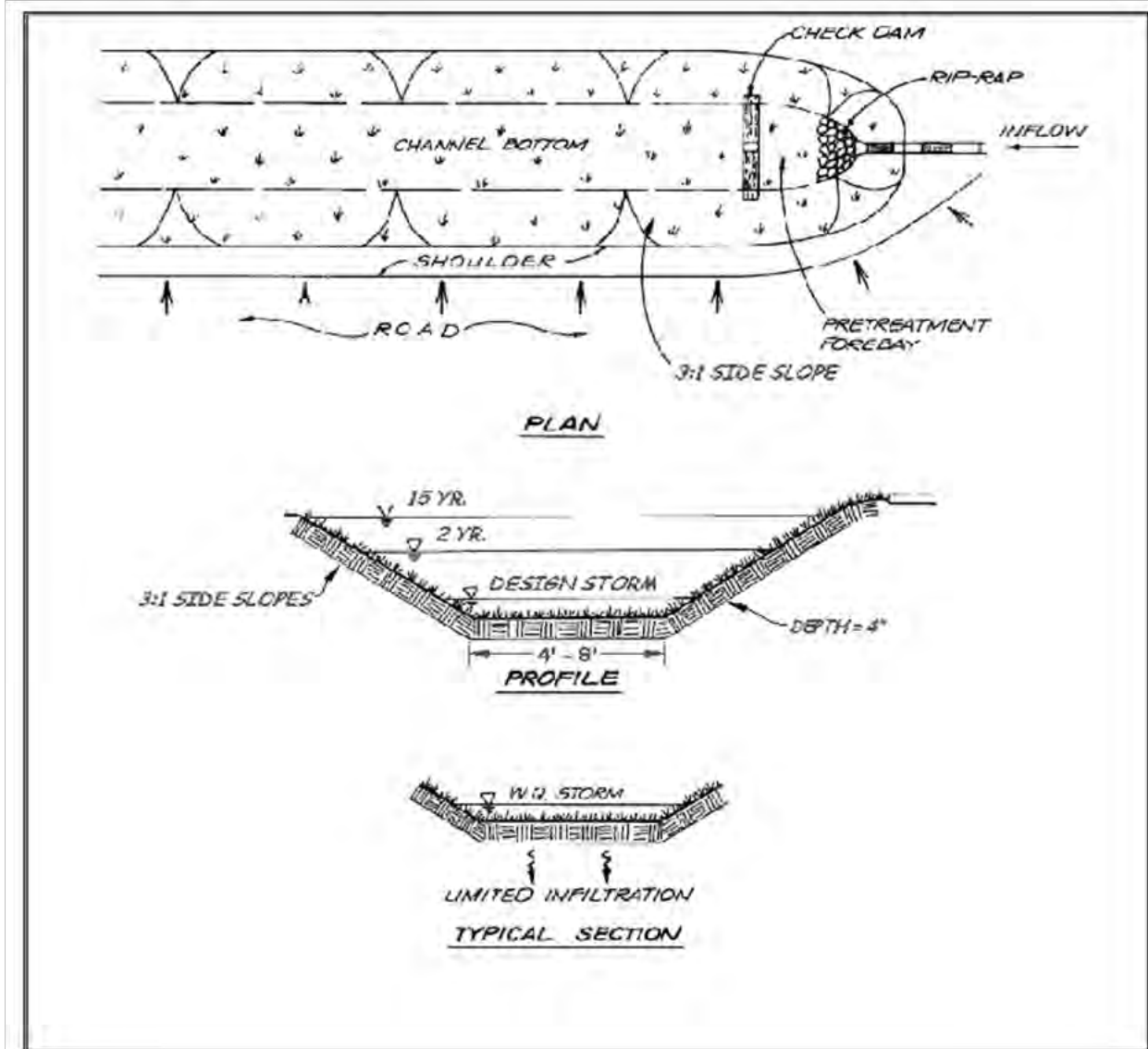


Figure 3.32 Grass channel typical plan, profile, and section views (O-1).

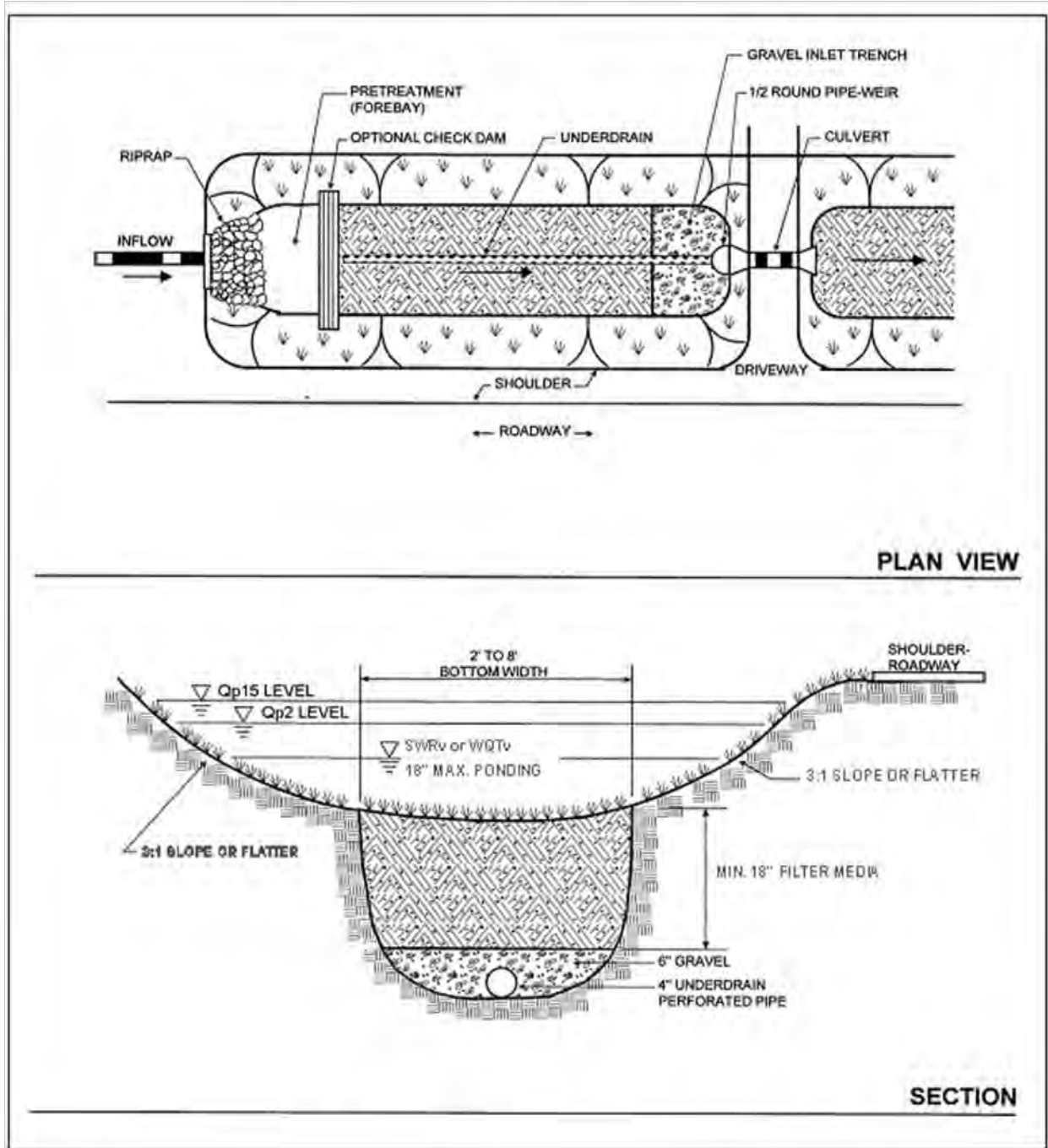


Figure 3.33 Example of a dry swale (O-2).

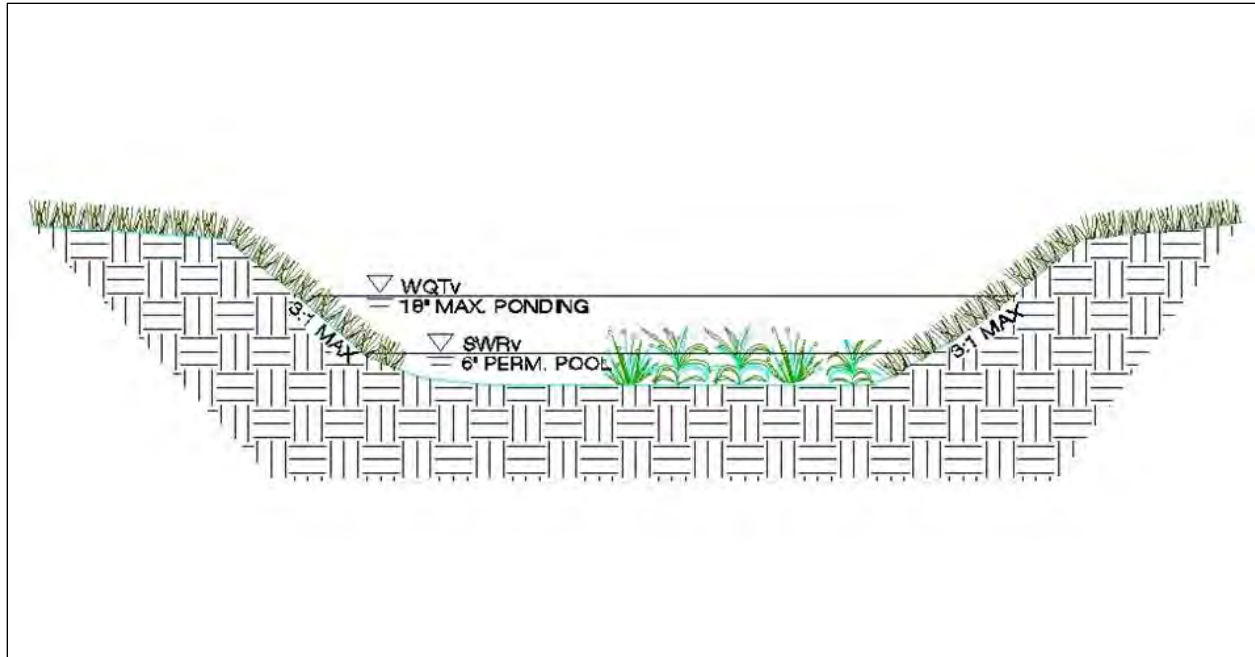


Figure 3.34 Example of a wet swale (O-3).

### 3.9.1 Open Channel Feasibility Criteria

Open channel systems are primarily applicable for land uses, such as roads, highways, and residential development. Some key feasibility issues for open channels include the following:

**Contributing Drainage Area.** The maximum contributing drainage area to an open channel should be 2.5 acres, preferably less. When open channels treat and convey runoff from drainage areas greater than 2.5 acres, the velocity and flow depth through the channel often becomes too great to treat runoff or prevent erosion in the channel. The design criteria for maximum channel velocity and depth are applied along the entire length (see Section 3.9.4 Open Channel Design Criteria).

**Available Space.** Open channel footprints can fit into relatively narrow corridors between utilities, roads, parking areas, or other site constraints. Dry Swales should be approximately 3 to 10 percent of the size of the contributing drainage area, depending on the amount of impervious cover. Wet swale footprints usually cover about 5 to 15 percent of their contributing drainage area. Grass channels can be incorporated into linear development applications (e.g., roadways) by utilizing the footprint typically required for an open section drainage feature. The footprint required will likely be greater than that of a typical conveyance channel. However, the benefit of the retention may reduce the footprint requirements for stormwater management elsewhere on the development site.

**Site Topography.** Grass channels and wet swales should be used on sites with longitudinal slopes of less than 4 percent. Check dams can be used to reduce the effective slope of the channel and lengthen the contact time to enhance filtering and/or infiltration. Longitudinal slopes

of less than 2 percent are ideal and may eliminate the need for check dams. However, channels designed with longitudinal slopes of less than 1 percent should be monitored carefully during construction to ensure a continuous grade, in order to avoid flat areas with pockets of standing water.

For dry swales, check dams will be necessary regardless of the longitudinal slope to create the necessary ponding volume.

**Land Uses.** Open channels can be used in residential, commercial, or institutional development settings.

When open channels are used for both conveyance and water quality treatment, they should be applied only in linear configurations parallel to the contributing impervious cover, such as roads and small parking areas. The linear nature of open channels makes them well-suited to treat highway or low- and medium-density residential road runoff, if there is adequate right-of-way width and distance between driveways. Typical applications of open channels include the following, as long as drainage area limitations and design criteria can be met:

- Within a roadway right-of-way;
- Along the margins of small parking lots;
- Oriented from the roof (downspout discharge) to the street;
- Disconnecting small impervious areas; and
- Used to treat the managed turf areas of sports fields, golf courses, and other turf-intensive land uses, or to treat drainage areas with both impervious and managed turf cover (such as residential streets and yards).

Open channels are not recommended when residential density exceeds more than 4 dwelling units per acre, due to a lack of available land and the frequency of driveway crossings along the channel.

Open channels can also provide pre-treatment for other stormwater treatment practices.

**Available Hydraulic Head.** A minimum amount of hydraulic head is needed to implement open channels in order to ensure positive drainage and conveyance through the channel. The hydraulic head for wet swales and grass channels is measured as the elevation difference between the channel inflow and outflow point. The hydraulic head for dry swales is measured as the elevation difference between the inflow point and the storm drain invert. Dry swales typically require 3 to 5 feet of hydraulic head since they have both a filter bed and underdrain.

**Hydraulic Capacity.** Open channels are typically designed as on-line practices which must be designed with enough capacity to (1) convey runoff from the 2-year and 15-year design storms at non-erosive velocities, and (2) contain the 15-year flow within the banks of the swale. This means that the swale's surface dimensions are more often determined by the need to pass the 15-year storm events, which can be a constraint in the siting of open channels within existing rights-of-way (e.g., constrained by sidewalks).

**Depth to Water Table.** The bottom of dry swales and grass channels must be at least 2 feet above the seasonally high groundwater table, to ensure that groundwater does not intersect the filter bed, since this could lead to groundwater contamination or practice failure. It is permissible for wet swales to intersect the water table.

**Soils.** Soil conditions do not constrain the use of open channels, although they do dictate some design considerations:

- Dry swales in soils with infiltration rates of less than 1/2 inch per hour may need an underdrain. Designers must verify site-specific soil permeability at the proposed location using the methods for on-site soil investigation presented in Appendix P, in order to eliminate the requirements for a dry swale underdrain.
- Grass channels situated on low-permeability soils may incorporate compost amendments in order to improve performance (see Appendix K).
- Wet swales work best on the more impermeable Hydrologic Soil Group (HSG) C or D soils.
- Infill soil locations, geotechnical investigations are required to determine if the use of an impermeable liner and underdrain are necessary for open channel designs.

**Utilities.** Typically, utilities can cross linear channels if they are specially protected (e.g., double-casing). Interference with underground utilities should be avoided, if possible. When large site development is undertaken, the expectation of achieving avoidance will be high. Conflicts may be commonplace on smaller sites and in the public right-of-way. Where conflicts cannot be avoided, these guidelines shall be followed:

- Consult with each utility company on recommended offsets that will allow utility maintenance work with minimal disturbance to the BMP.
- Whenever possible, coordinate with utility companies to allow them to replace or relocate their aging infrastructure while BMPs are being implemented.
- BMP and utility conflicts will be a common occurrence in public right-of-way projects. However, the standard solution to utility conflict should be the acceptance of conflict provided sufficient soil coverage over the utility can be assured.
- Additionally, when accepting utility conflict into the BMP design, it is understood that the BMP will be temporarily impacted during utility maintenance but restored to its original condition.

**Avoidance of Irrigation or Baseflow.** Open channels should be located so as to avoid inputs of springs, irrigation systems, chlorinated wash-water, or other dry weather flows.

**Setbacks.** Setback to avoid the risk of seepage, open channels must not be hydraulically connected to structure foundations. Setbacks to structures must be at least 10 feet and adequate water-proofing protection must be provided for foundations and basements.

**Hotspot Land Use.** Runoff from hotspot land uses must not be treated with infiltrating dry swales due to the potential interaction with the water table and the risk that hydrocarbons, trace metals, and other toxic pollutants could migrate into the groundwater. An impermeable liner

must be used for filtration of hotspot runoff for dry swales. Grass channels can typically be used to convey runoff from stormwater hotspots, but they do not qualify as a hotspot treatment mechanism. Wet swales are not recommended to treat stormwater hotspots, due to the potential interaction with the water table and the risk that hydrocarbons, trace metals, and other toxic pollutants could migrate into the groundwater. For a list of designated stormwater hotspot operations, consult Appendix Q.

On sites with existing contaminated soils, as indicated in Appendix Q, infiltration is not allowed. Dry and wet swales must include an impermeable liner.

### 3.9.2 Open Channel Conveyance Criteria

The bottom width and slope of a grass channel must be designed such that the velocity of flow from the design storm provides a minimum hydraulic residence time (average travel time for a particle of water through a water body) of 9 minutes for the peak flows from the SWRv or design storm. Check dams may be used to achieve the needed retention volume, as well as to reduce the flow velocity. Check dams must be spaced based on channel slope and ponding requirements, consistent with the criteria in Section 3.9.4 Open Channel Design Criteria.

Open channels must also convey the 2- and 15-year storms at non-erosive velocities (generally less than 6 fps) for the soil and vegetative cover provided. The final designed channel shall provide 1 foot minimum freeboard above the designated water surface profile of the channel. The analysis must evaluate the flow profile through the channel at normal depth, as well as the flow depth over top of the check dams.

### 3.9.3 Open Channel Pretreatment Criteria

Pretreatment is required for open channels to dissipate energy, trap sediments, and slow down the runoff velocity.

The selection of a pre-treatment method depends on whether the channel will experience sheet flow or concentrated flow. Several options are as follows:

- **Check Dams (channel flow).** These energy dissipation devices are acceptable as pre-treatment on small open channels with drainage areas of less than 1 acre. The most common form is the use of wooden or stone check dams. The pretreatment volume stored must be 15 percent of the design volume.
- **Tree Check Dams (channel flow).** These are street tree mounds that are placed within the bottom of grass channels up to an elevation of 9 to 12 inches above the channel invert. One side has a gravel or river stone bypass to allow runoff to percolate through (Cappiella et al, 2006). The pretreatment volume stored must be 15 percent of the design volume.
- **Grass Filter Strip (sheet flow).** Grass filter strips extend from the edge of the pavement to the bottom of the open channel at a slope of 5:1 or flatter. Alternatively, provide a combined 5 feet of grass filter strip at a maximum 5 percent (20:1) cross slope and 3:1 or flatter side slopes on the open channel.

- **Gravel or Stone Diaphragm (sheet flow).** The gravel diaphragm is located at the edge of the pavement or the edge of the roadway shoulder and extends the length of the channel to pre-treat lateral runoff. This requires a 2 to 4 inch elevation drop from a hard-edged surface into a gravel or stone diaphragm. The stone must be sized according to the expected rate of discharge.
- **Gravel or Stone Flow Spreaders (concentrated flow).** The gravel flow spreader is located at curb cuts, downspouts, or other concentrated inflow points, and should have a 2 to 4 inch elevation drop from a hard-edged surface into a gravel or stone diaphragm. The gravel should extend the entire width of the opening and create a level stone weir at the bottom or treatment elevation of the channel.
- **Initial Sediment Forebay (channel flow).** This grassed cell is located at the upper end of the open channel segment with a recommended 2:1 length to width ratio and a storage volume equivalent to at least 15 percent of the total design storm volume. If the volume of the forebay will be included as part of the dry swale storage volume, the forebay must de-water between storm events. It cannot have a permanent ponded volume.

### 3.9.4 Open Channel Design Criteria

**Channel Geometry.** Design guidance regarding the geometry and layout of open channels is provided below:

- Open channels should generally be aligned adjacent to and the same length as the contributing drainage area identified for treatment.
- Open channels should be designed with a trapezoidal or parabolic cross section. A parabolic shape is preferred for aesthetic, maintenance, and hydraulic reasons.
- The bottom width of the channel should be between 4 to 8 feet wide to ensure that an adequate surface area exists along the bottom of the swale for filtering. If a channel will be wider than 8 feet, the designer must incorporate benches, check dams, level spreaders, or multi-level cross sections to prevent braiding and erosion along the channel bottom.
- Open channel side slopes should be no steeper than 3H:1V for ease of mowing and routine maintenance. Flatter slopes are encouraged, where adequate space is available, to enhance pre-treatment of sheet flows entering the channel.

**Check dams.** Check dams may be used for pre-treatment, to break up slopes, and to increase the hydraulic residence time in the channel. Design requirements for check dams are as follows:

- Check dams should be spaced based on the channel slope, as needed to increase residence time, provide design storm storage volume, or any additional volume attenuation requirements. In typical spacing, the ponded water at a downhill check dam should not touch the toe of the upstream check dam. More frequent spacing may be desirable in dry swales to increase the ponding volume.
- The maximum desired check dam height is 12 inches, for maintenance purposes. However, for some sites, a maximum of 18 inches can be allowed, with additional design elements to



ensure the stability of the check dam and the adjacent and underlying soils. The average ponding depth throughout the channel should be 12 inches.

- Armoring may be needed at the downstream toe of the check dam to prevent erosion.
- Check dams must be firmly anchored into the side-slopes to prevent outflanking; check dams must also be anchored into the channel bottom so as to prevent hydrostatic head from pushing out the underlying soils.
- Check dams must be designed with a center weir sized to pass the channel design storm peak flow (15-year storm event for man-made channels).
- For grass channels, each check dam must have a weep hole or similar drainage feature so it can dewater after storms. This is not appropriate for dry swales.
- Check dams should be composed of wood, concrete, stone, compacted soil, or other non-erodible material, or should be configured with elevated driveway culverts.
- Individual channel segments formed by check dams or driveways should generally be at least 25 to 40 feet in length.

Check dams for grass channels must be spaced to reduce the effective slope to less than 2 percent, as indicated below in Table 3.35.

**Table 3.35 Typical Check Dam Spacing to Achieve Effective Channel Slope**

Channel Longitudinal Slope (%)	Check Dam <sup>a, b</sup> Spacing <sup>c</sup> to Achieve Effective Slope (ft)	
	Effective Slope of 2%	Effective Slope of 0%–1%
0.5	–	200–
1.0	–	100–
1.5	–	67–200
2.0	–	50–100
2.5	200	40–67
3.0	100	33–50
3.5	67	30–40
4.0	50	25–33
4.5 <sup>d</sup>	40	20–30
5.0 <sup>d</sup>	40	20–30

Notes:

<sup>a</sup> All check dams require a stone energy dissipater at the downstream toe.

<sup>b</sup> Check dams require weep holes at the channel invert. Swales with slopes less than 2 percent will require multiple weep holes (at least 3) in each check dam.

<sup>c</sup> Maximum check dam spacing height is 12 inches. The spacing dimension is half of the above distances if a 6-inch check dam is used.

<sup>d</sup> Open channels with slopes greater than 4 percent require special design considerations, such as drop structures to accommodate greater than 12-inch high check dams (and therefore a flatter effective slope), in order to ensure non-erosive flows.

**Ponding Depth.** Check dams must be used in dry swales to create ponding cells along the length of the channel. The maximum ponding depth in a dry swale must not exceed 18 inches. Minimum surface ponding depth is 3 inches (averaged over the surface area of the open channel). In order to increase the ponding depth, it may be necessary or desirable to space check dams more frequently than is shown in Table 3.35.

**Dry Swale Filter Media.** Dry swales require replacement of native soils with a prepared filter media. The soil media provides adequate drainage, supports plant growth, and facilitates pollutant removal within the dry swale. At least 18 inches of filter media must be added above the choker stone layer (and no more than 6 feet) to create an acceptable filter. The recipe for the filter media is identical to that used for bioretention and is provided in Section 3.6 Bioretention. The batch receipt confirming the source of the filter media must be submitted to the DDOE inspector. One acceptable design adaptation is to use 100 percent sand for the first 18 inches of the filter and add a combination of topsoil and compost, as specified in Appendix K, for the top 4 inches, where turf cover will be maintained.

**Dry Swale Drawdown.** Dry swales must be designed so that the desired design storm volume is completely filtered within 72 hours, using the equations specified in Section 3.9.6.

**Dry Swale Underdrain.** Some dry swale designs will not use an underdrain (where soil infiltration rates meet minimum standards). See Section 3.9.1 Open Channel Feasibility Criteria for more details. When underdrains are necessary, they should have a minimum diameter of 4 to 6 inches and be encased in a 12-inch deep gravel bed. Two layers of stone should be used. A choker stone layer, consisting of #8 or #78 stone at least 3 inches deep, must be installed immediately below the filter media. Below the choker stone layer, the underdrain must be encased (a minimum of 2 inches above and below the underdrain) in a layer of clean, washed ASTM D448 No.57 or smaller (No. 68, 8, or 89) stone.

**Impermeable Liner.** An impermeable liner is not typically required, although it may be utilized in fill applications where deemed necessary by a geotechnical investigation, on sites with contaminated soils, or on the sides of the practice to protect adjacent structures from seepage. Use a 30-mil (minimum) PVC geomembrane liner. (Follow manufacturer's instructions for installation.) Field seams must be sealed according to the liner manufacturer's specifications. A minimum 6-inch overlap of material is required at all seams.

**Dry Swale Observation Well.** A dry swale must include observation wells with cleanout pipes along the length of the swale. The wells should be tied into any Ts or Ys in the underdrain system and must extend upward above the surface of the dry swale.

**Grass Channel Material Specifications.** The basic material specifications for grass channels are outlined in Table 3.36 below.

**Table 3.36 Grass Channel Material Specifications**

Component	Specification
Grass	<p>A dense cover of water-tolerant, erosion-resistant grass. The selection of an appropriate species or mixture of species is based on several factors including climate, soil type, topography, and sun or shade tolerance.</p> <p>Grass species should have the following characteristics:</p> <ul style="list-style-type: none"> <li>▪ A deep root system to resist scouring;</li> <li>▪ A high stem density with well-branched top growth;</li> <li>▪ Water-tolerance;</li> <li>▪ Resistance to being flattened by runoff;</li> <li>▪ An ability to recover growth following inundation; and</li> <li>▪ If receiving runoff from roadways, salt-tolerance.</li> </ul>
Check Dams	<p>Check dams should be constructed of a non-erosive material such as wood, gabions, riprap, or concrete. Wood used for check dams should consist of pressure treated logs or timbers, or water-resistant tree species such as cedar, hemlock, swamp oak, or locust. Computation of check dam material is necessary, based on the surface area and depth used in the design computations.</p>
Diaphragm	<p>Pea gravel used to construct pre-treatment diaphragms must consist of washed, open-graded, course aggregate between 3 and 10 mm in diameter.</p>
Erosion Control Fabric	<p>Where flow velocities dictate, biodegradable erosion control netting or mats that are durable enough to last at least two growing seasons must be used, conforming to Standard and Specification 3.36 of the Virginia Erosion and Sediment Control Handbook.</p>

**Dry Swale Material Specifications.** For additional material specifications pertaining to dry swales, designers should consult Section 3.6.4 and Table 3.37 below.

**Table 3.37 Dry Swale Material Specifications**

Material	Specification	Notes
Filter Media Composition	<p>Filter Media to contain:</p> <ul style="list-style-type: none"> <li>▪ 80-90% sand</li> <li>▪ 10-20% soil fines</li> <li>▪ Maximum 10% clay</li> <li>▪ 3-5% organic matter</li> </ul>	<p>To account for settling/compaction, it is recommended that 110% of the plan volume be utilized.</p>
Filter Media Testing	<p>P content = 5 to 15 mg/kg (Mehlich I) or 18 to 40 mg/kg (Mehlich III) CEC &gt; 5 milliequivalents per 100 grams</p>	<p>See Section 3.6 Bioretention, for additional soil media information.</p>
Geotextile	<p>Geotextile fabric meeting the following specifications:</p> <ul style="list-style-type: none"> <li>▪ AASHTO M-288 Class 2, latest edition</li> <li>▪ Has a permeability of at least an order of magnitude higher (10x) than the soil subgrade permeability</li> <li>▪ Apply along sides of the filter media only and do not apply along the swale bottom.</li> </ul>	
Choking Layer	<p>A 2 to 4 inch layer of choker stone (typically #8 or # 89 washed gravel) laid above the underdrain stone.</p>	

Material	Specification	Notes
Underdrain Stone Layer	Stone must be double-washed and clean and free of all fines (ASTM D448 No. 57 or smaller stone).	
Underdrains, Cleanouts, and Observation Wells	4-inch or 6-inch rigid schedule 40 PVC pipe, with 3/8-inch perforations.	Install perforated pipe for the full length of the Dry Swale cell. Use non-perforated pipe, as needed, to connect with the storm drain system.
Impermeable Liner	Where appropriate, use a thirty mil (minimum) PVC Geomembrane liner	
Vegetation	Plant species as specified on the landscaping plan	
Check Dams	Use non-erosive material, such as wood, gabions, riprap, or concrete. Wood used for check dams should consist of pressure-treated logs or timbers, or water-resistant tree species, such as cedar, hemlock, swamp oak, or locust.	
Erosion Control Fabric	Where flow velocities dictate, use woven biodegradable erosion control fabric or mats (EC2) that are durable enough to last at least 2 growing seasons.	

**Wet Swale Design Issues.** The following criteria apply to the design of wet swales:

- The average normal pool depth (dry weather) throughout the swale must be 6 inches or less.
- The maximum temporary ponding depth in any single Wet Swale cell must not exceed 18 inches at the most downstream point (e.g., at a check dam or driveway culvert).
- Check dams should be spaced as needed to maintain the effective longitudinal slope.
- Individual Wet Swale segments formed by check dams or driveways should generally be at least 25 to 40 feet in length.
- Wet Swale side slopes should be no steeper than 4H:1V to enable wetland plant growth. Flatter slopes are encouraged where adequate space is available, to enhance pre-treatment of sheet flows entering the channel. Under no circumstances are side slopes to steeper than 3H:1V.

**Grass Channel Enhancement using Compost Soil Amendments.** Soil compost amendments serve to increase the retention capability of a grass channel. The following design criteria apply when compost amendments are used:

- The compost-amended strip must extend over the length and width of the channel bottom, and the compost must be incorporated to a depth as outlined in Appendix K.
- The amended area will need to be rapidly stabilized with perennial, salt tolerant grass species.
- For grass channels on steep slopes, it may be necessary to install a protective biodegradable erosion control mat to protect the compost-amended soils. Care must be taken to consider the erosive characteristics of the amended soils when selecting an appropriate erosion control mat.

**Grass Channel Sizing.** Unlike other BMPs, grass channels are designed based on a peak rate of flow. Designers must demonstrate channel conveyance and treatment capacity in accordance with the following guidelines:

- Hydraulic capacity should be verified using Manning’s Equation or an accepted equivalent method, such as erodibility factors and vegetal retardance.
- The flow depth for the peak flow generated by the SWRv must be maintained at 4 inches or less.
- Manning’s “*n*” value for grass channels is 0.2 for flow depths up to 4 inches, decreasing to 0.03 at a depth of 12 inches and above, which would apply to the 2-year and 15-year storms if an on-line application (Haan et. al, 1994).
- Peak flow rates for the 2-year and 15-year frequency storms must be non-erosive, in accordance with Table 3.38 (see Section 3.9.5 Open Channel Landscaping Criteria), or subject to a site-specific analysis of the channel lining material and vegetation; and the 15-year peak flow rate must be contained within the channel banks (with a minimum of 6 inches of freeboard).
- Calculations for peak flow depth and velocity must reflect any increase in flow along the length of the channel, as appropriate. If a single flow is used, the flow at the outlet must be used.
- The hydraulic residence time (e.g., the average travel time for a particle of water through a water body) must be a minimum of 9 minutes for the peak flows from the SWRv or design storm (Mar et al., 1982; Barrett et al., 1998; Washington State Department of Ecology, 2005). If flow enters the swale at several locations, a 9-minute minimum hydraulic residence time must be demonstrated for each entry point, using Equation 3.15 through Equation 3.19 below.

The bottom width of the grass channel is therefore sized to maintain the appropriate flow geometry as follows:

**Equation 3.15 Manning’s Equation**

$$V = \left( \frac{1.49}{n} \right) \times D^{2/3} \times S^{1/2}$$

where:

- V* = flow velocity (ft/s)
- n* = roughness coefficient (0.2, or as appropriate)
- D* = flow depth (ft) (Note: *D* approximates hydraulic radius for shallow flows)
- S* = channel slope (ft/ft)

**Equation 3.16 Continuity Equation**

$$Q = V(W \times D)$$

where:

- Q = design storm peak flow rate (cfs)
- V = design storm flow velocity (ft/s)
- W = channel width (ft)
- D = flow depth (ft)

(Note: Channel width (W) multiplied by depth (D) approximates the cross-sectional flow area for shallow flows.)

Combining Equation 3.15 and Equation 3.16, and re-writing them provides a solution for the minimum width:

**Equation 3.17 Minimum Width**

$$W = \frac{n \times Q}{1.49 \times D^{5/3} \times S^{1/2}}$$

Solving Equation 3.20 for the corresponding velocity provides:

**Equation 3.18 Corresponding Velocity**

$$V = \frac{Q}{W \times D}$$

The width, slope, or Manning’s “n” value can be adjusted to provide an appropriate channel design for the site conditions. However, if a higher density of grass is used to increase the Manning’s “n” value and decrease the resulting channel width, it is important to provide material specifications and construction oversight to ensure that the denser vegetation is actually established. Equation 3.19 can then be used to ensure adequate hydraulic residence time.

**Equation 3.19 Grass Channel Length for Hydraulic Residence Time of 9 minutes (540 seconds)**

$$L = 540 \times V$$

where:

- L = minimum swale length (ft)
- V = flow velocity (ft/s)

The storage volume (Sv) provided by the grass channel is equal to the total runoff from the design storm (typically SWRv) used to size the channel (conveyed at a depth of 4 inches or less).

**Equation 3.20 Grass Channel Storage Volume**

$$Sv = DesignStorm$$

where:

$$DesignStorm = SWRv \text{ or other design storm volume (ft}^3\text{) (e.g., portion of the } SWRv\text{)}$$

**Dry Swale Sizing.** Dry swales are typically sized to capture the SWRv or larger design storm volumes in the surface ponding area, soil media, and gravel reservoir layers of the dry swale.

Total storage volume of the BMP is calculated using Equation 3.21.

**Equation 3.21 Dry Swale Storage Volume**

$$Sv = SA_{bottom} \times [(d_{media} \times \eta_{media}) + (d_{gravel} \times \eta_{gravel})] + (SA_{average} \times d_{ponding})$$

where:

$Sv$	=	total storage volume of dry swale (ft <sup>3</sup> )
$SA_{bottom}$	=	bottom surface area of dry swale (ft <sup>2</sup> )
$d_{media}$	=	depth of the filter media (ft)
$\eta_{media}$	=	effective porosity of the filter media (typically 0.25)
$d_{gravel}$	=	depth of the underdrain and underground storage gravel layer(ft)
$\eta_{gravel}$	=	effective porosity of the gravel layer (typically 0.4)
$SA_{average}$	=	the average surface area of the dry swale (ft <sup>2</sup> ) (typically, $\frac{1}{2} \times (\text{top area} + SA_{bottom} \text{ area})$ )
$d_{ponding}$	=	the maximum ponding depth of the dry swale (ft)

Equation 3.21 can be modified if the storage depths of the soil media, gravel layer, or ponded water vary in the actual design or with the addition of any surface or subsurface storage components (e.g., additional area of surface ponding, subsurface storage chambers, etc.). The maximum depth of ponding in the dry swale must not exceed 18 inches. If storage practices will be provided off-line or in series with the dry swale, the storage practices should be sized using the guidance in Section 3.12 Storage Practices.

Dry swales can be designed to address, in whole or in part, the detention storage needed to comply with channel protection and/or flood control requirements. The  $Sv$  can be counted as part of the 2-year or 15-year runoff volumes to satisfy stormwater quantity control requirements.

Note: In order to increase the storage volume of a dry swale, the ponding surface area may be increased beyond the filter media surface area. However, the top surface area of the BMP (at the top of the ponding elevation) may not be more than twice the size of surface area of the filter media ( $SA_{bottom}$ ). **Wet Swale Sizing.** Wet swales can be designed to capture and treat the SWRv remaining from any upstream stormwater retention practices. The storage volume is made up of

the temporary and permanent storage created within each wet swale cell. This includes the permanent pool volume and up to 12 inches of temporary storage created by check dams or other design features that has 24 hours extended detention.

The storage volume ( $S_v$ ) of the practice is equal to the volume provided by the pond permanent pool plus the 24-hour extended detention (ED) volume provided by the practice (Equation 3.22). The total  $S_v$  cannot exceed the design  $SWR_v$ .

**Equation 3.22 Wet Swale Storage Volume**

$$S_v = \text{Pond permanent pool volume} + \text{24-hour ED volume}$$

**3.9.5 Open Channel Landscaping Criteria**

All open channels must be stabilized to prevent erosion or transport of sediment to receiving practices or drainage systems. There are several types of grasses appropriate for dry open channels (grass channels and dry swales). These are listed in Table 3.38. Designers should choose plant species that can withstand both wet and dry periods and relatively high velocity flows for planting within the channel. Designers should ensure that the maximum flow velocities do not exceed the values listed in the table for the selected grass species and the specific site slope.

**Table 3.38 Recommended Vegetation for Open Channels**

Vegetation Type	Slope (%)	Maximum Velocity (ft/s)	
		Erosion Resistant Soil	Easily Eroded Soil
Bermuda Grass	0-5	8	6
	5-10	7	5
	>10	6	4
Kentucky Bluegrass	0-5	7	5
	5-10	6	4
	>10	5	3
Tall Fescue Grass Mixture	0-5	6	4
	5-10	4	3
Annual and Perennial Rye	0-5	4	3
Sod		4	3

Source: USDA, TP-61, 1954; Roanoke Virginia, Stormwater Design Manual, 2008

Wet swales should be planted with grass and wetland plant species that can withstand both wet and dry periods as well as relatively high velocity flows within the channel. For a list of wetland plant species suitable for use in wet swales, refer to the wetland planting guidance and plant lists provided in Section 3.11 Stormwater Wetlands.

If roadway salt will be applied to the contributing drainage area, open channels should be planted with salt-tolerant plant species.



Landscape design shall specify proper grass species based on site-specific soils and hydric conditions present along the channel.

Open channels should be seeded at such a density to achieve a 90 percent vegetated cover after the second growing season. Taller and denser grasses are preferable, although the species is less important than good stabilization and dense vegetative cover.

Grass channels should be seeded and not sodded. Seeding establishes deeper roots and sod may have muck soil that is not conducive to infiltration. Grass channels should be protected by a biodegradable erosion control fabric to provide immediate stabilization of the channel bed and banks.

### 3.9.6 Open Channel Construction Sequence

**Design Notes.** Channel invert and tops of banks are to be shown in plan and profile views. A cross sectional view of each configuration must be shown for proposed channels. Completed limits of grading must be shown for proposed channels. For proposed channels, the transition at the entrance and outfall is to be clearly shown on plan and profile views.

**Open Channel Installation.** The following is a typical construction sequence to properly install open channels, although steps may be modified to reflect different site conditions or design variations. Grass channels should be installed at a time of year that is best to establish turf cover without irrigation. For more specific information on the installation of wet swales, designers should consult the construction criteria outlined in Section 3.11 Stormwater Wetlands.

**Step 1: Protection During Site Construction.** Ideally, open channels should remain outside the limit of disturbance during construction to prevent soil compaction by heavy equipment. However, this is seldom practical, given that the channels are a key part of the drainage system at most sites. In these cases, temporary erosion and sediment controls such as dikes, silt fences and other erosion control measures should be integrated into the swale design throughout the construction sequence. Specifically, barriers should be installed at key check dam locations, and erosion control fabric should be used to protect the channel. Dry Swales that lack underdrains (and rely on infiltration) must be fully protected by silt fence or construction fencing to prevent compaction by heavy equipment during construction.

**Step 2: Installation.** Installation may only begin after the entire contributing drainage area has been stabilized with vegetation. Any accumulation of sediments that does occur within the channel must be removed during the final stages of grading to achieve the design cross section. Erosion and sediment controls for construction of the channel must be installed as specified in the erosion and sediment control plan. Stormwater flows must not be permitted into the channel until the bottom and side slopes are fully stabilized.

**Step 3: Grading.** Grade the grass channel to the final dimensions shown on the plan. Excavators or backhoes should work from the sides to grade and excavate the open channels to the appropriate design dimensions. Excavating equipment should have scoops with adequate reach so they do not have to sit inside the footprint of the open channel area. If constructing a dry swale, the bottom of the swale should be ripped, roto-tilled or otherwise scarified to promote greater infiltration.

**Step 4: Placing Stone Layer (for dry swales).** If constructing a dry swale, place an acceptable geotextile fabric on the underground (excavated) sides of the dry swale with a minimum 6 inch overlap. Place the stone needed for storage layer over the filter bed. Perforate the underdrain pipe. Add the remaining stone jacket, and then pack #57 stone (washed and clean) to 3 inches above the top of the underdrain, and then add 3 inches of pea gravel as a filter layer. Add the soil media in 12-inch lifts until the desired top elevation of the dry swale is achieved. Water thoroughly and add additional media as needed where settlement has occurred.

**Step 5: Add Amendments (optional, for grass channels).** Add soil amendments as needed. Till the bottom of the grass channel to a depth of 1 foot and incorporate compost amendments according to Appendix K.

**Step 6: Install Check Dams.** Install check dams, driveway culverts and internal pre-treatment features as shown on the plan. Fill material used to construct check dams should be placed in 8- to 12-inch lifts and compacted to prevent settlement. The top of each check dam must be constructed level at the design elevation.

**Step 7: Hydro-seed the bottom and banks of the open channel, and peg in erosion control fabric or blanket where needed.** After initial planting, a biodegradable erosion control fabric should be used, conforming to the District of Columbia Erosion and Sediment Control Standards and Specifications.

**Step 8: Plant.** Plant landscaping materials as shown in the landscaping plan, and water them weekly during the first 2 months. The construction contract should include a care and replacement warranty to ensure that vegetation is properly established and survives during the first growing season following construction.

**Step 9: Final Inspection.** A qualified professional should conduct the final construction inspection and develop a punch list for facility acceptance.

**Open Channel Construction Supervision.** Supervision during construction is recommended to ensure that the open channel is built in accordance with these specifications.

DDOE's construction phase inspection checklist is available in Appendix L.

Some common pitfalls can be avoided by careful construction supervision that focuses on the following key aspects of dry swale installation:

- Make sure the desired coverage of turf or erosion control fabric has been achieved following construction, both on the channel beds and their contributing side-slopes.
- Inspect check dams and pre-treatment structures to make sure they are at correct elevations, are properly installed, and are working effectively.
- For dry swale designs:
  - ◆ Check the filter media to confirm that it meets specifications and is installed to the correct depth.
  - ◆ Check elevations, such as the invert of the underdrain, inverts for the inflow and outflow points, and the ponding depth provided between the surface of the filter bed and the overflow structure.

- ◆ Ensure that caps are placed on the upstream (but not the downstream) ends of the underdrains.
- ◆ Check that outfall protection/energy dissipation measures at concentrated inflow and outflow points are stable.

The real test of an open channel occurs after its first big storm. The post-storm inspection should focus on whether the desired sheetflow, shallow concentrated flows or fully concentrated flows assumed in the plan actually occur in the field. Minor adjustments are normally needed as part of this post-storm inspection (e.g., spot reseeding, gully repair, added armoring at inlets, or realignment of outfalls and check dams). Also, a qualified professional should check that dry swale practices drain completely within the 72-hour drawdown period.

### 3.9.7 Open Channel Maintenance Criteria

Maintenance is a crucial and required element that ensures the long-term performance of open channels. Once established, grass channels have minimal maintenance needs outside of the spring cleanup, regular mowing, repair of check dams and other measures to maintain the hydraulic efficiency of the channel and a dense, healthy grass cover. Dry swale designs may require regular pruning and management of trees and shrubs. The surface of dry swale filter beds can become clogged with fine sediment over time, but this can be alleviated through core aeration or deep tilling of the filter bed. Additional effort may be needed to repair check dams, stabilize inlet points, and remove deposited sediment from pre-treatment cells. Table 3.39 provides a schedule of typical maintenance activities required for open channels.

**Table 3.39 Typical Maintenance Activities and Schedule for Open Channels**

Schedule	Maintenance Activity
As needed	<ul style="list-style-type: none"> <li>▪ Mow grass channels and dry swales during the growing season to maintain grass heights in the 4- to 6-inch range.</li> </ul>
Quarterly	<ul style="list-style-type: none"> <li>▪ Ensure that the contributing drainage area, inlets, and facility surface are clear of debris.</li> <li>▪ Ensure that the contributing drainage area is stabilized. Perform spot-reseeding if where needed.</li> <li>▪ Remove accumulated sediment and oil/grease from inlets, pre-treatment devices, flow diversion structures, and overflow structures.</li> <li>▪ Repair undercut and eroded areas at inflow and outflow structures.</li> </ul>
Annual inspection	<ul style="list-style-type: none"> <li>▪ Add reinforcement planting to maintain 90% turf cover. Reseed any salt-killed vegetation.</li> <li>▪ Remove any accumulated sand or sediment deposits behind check dams.</li> <li>▪ Inspect upstream and downstream of check dams for evidence of undercutting or erosion, and remove trash or blockages at weepholes.</li> <li>▪ Examine channel bottom for evidence of erosion, braiding, excessive ponding or dead grass.</li> <li>▪ Check inflow points for clogging and remove any sediment.</li> <li>▪ Inspect side slopes and grass filter strips for evidence of any rill or gully erosion and repair.</li> <li>▪ Look for any bare soil or sediment sources in the contributing drainage area and stabilize immediately.</li> </ul>

**Maintenance Inspections.** Annual inspections by a qualified professional are used to trigger maintenance operations, such as sediment removal, spot revegetation, and inlet stabilization. DDOE’s maintenance inspection checklists for disconnection can be found in Appendix M.

**Declaration of Covenants.** A declaration of covenants that includes all maintenance responsibilities to ensure the continued stormwater performance for the BMP is required. The declaration of covenants specifies the property owner’s primary maintenance responsibilities, and authorizes DDOE staff to access the property for inspection or corrective action in the event the proper maintenance is not performed. The declaration of covenants is attached to the deed of the property. An example form is provided at the end of Chapter 5 though variations will exist for scenarios where stormwater crosses property lines. The covenant is between the property and the District Government. It is submitted through the Office of the Attorney General (OAG). All SWMPs have a maintenance agreement stamp that must be signed for a building permit to proceed. A maintenance schedule must appear on the SWMP. Additionally, a maintenance schedule is required in schedule c of the declaration of covenants.

Covenants are not required on government properties, but maintenance responsibilities must be defined through a partnership agreement or a memorandum of understanding.

**Waste Material.** Waste material from the repair, maintenance, or removal of a BMP or land cover shall be removed and disposed of in compliance with applicable federal and District law.

### 3.9.8 Open Channel Stormwater Compliance Calculations

Grass Channels receive 10 percent retention value for the amount of storage volume (Sv) provided by the practice (Table 3.40).

**Table 3.40 Grass Channel Retention Value and Pollutant Removal**

Retention Value	= $0.1 \times Sv$
Accepted TSS Treatment Practice	No

Grass channels on amended soils receive 30 percent retention value for the amount of storage volume (Sv) provided by the practice (Table 3.41).

**Table 3.41 Grass Channel on Amended Soils Retention Value and Pollutant Removal**

Retention Value	= $0.3 \times Sv$
Accepted TSS Treatment Practice	No

Dry swales receive 60 percent retention value and are an accepted TSS removal practice for the amount of storage volume (Sv) provided by the practice (Table 3.42).

**Table 3.42 Dry Swale Retention Value and Pollutant Removal**

Retention Value	$= 0.6 \times Sv$
Accepted TSS Treatment Practice	Yes

Wet swales receive 10 percent retention value and are an accepted TSS removal practice for the amount of storage volume ( $Sv$ ) provided by the BMP (Table 3.43).

**Table 3.43 Wet Swale Retention Value and Pollutant Removal**

Retention Value	$= 0.1 \times Sv$
Accepted TSS Treatment Practice	Yes

All practices must be sized using the guidance detailed in Section 3.9.4. Open Channel Design Criteria.

Grass channels and dry swales also contribute to peak flow reduction. This contribution can be determined in several ways. One method is to subtract the  $Sv$  or Retention Value from the total runoff volume for the 2-year, 15-year, and 100-year storms. The resulting reduced runoff volumes can then be used to calculate a Reduced Natural Resource Conservation Service (NRCS) Curve Number for the site or drainage area. The Reduced Curve Number can then be used to calculate peak flow rates for the various storm events. Other hydrologic modeling tools that employ different procedures may be used as well.

### 3.9.9 References

- Barrett, Michael E., Michael V. Keblin, Partrick M. Walsh, Joseph F. Malina, Jr., and Randall J. Charbeneau. 1998. Evaluation of the Performance of Permanent Runoff Controls: Summary and Conclusions. Center for Transportation Research Bureau of Engineering Research. The University of Texas at Austin. Available online at: [http://www.utexas.edu/research/ctr/pdf\\_reports/2954\\_3F.pdf](http://www.utexas.edu/research/ctr/pdf_reports/2954_3F.pdf)
- Haan, C.T., Barfield, B.J., and Hayes, J.C. Design Hydrology and Sedimentology for Small Catchments. Academic Press, New York, 1994.
- Mar, B.W., R.R. Horner, J.F. Ferguson, D.E. Spyridakis, E.B. Welch. 1982. Summary of Highway Runoff Water Quality Study, 1977-1982. WA RD 39.16. September, 1982.
- Roanoke Virginia, Stormwater Design Manual. 2008. Stormwater Management Design Manual. Department of Planning Building and Development. Roanoke, Virginia.

USDA. 1954. Handbook of Channel of Design for Soil and Water Conservation. Stillwater Outdoor Hydraulic Laboratory and the Oklahoma Agricultural Experiment Station. SCS-TP-61, Washington, DC.

Virginia DCR Stormwater Design Specification No. 3: Grass Channels Version 1.8. 2010.

Virginia DCR Stormwater Design Specification No. 10: Dry Swales Version 1.8. 2010.

Virginia DCR Stormwater Design Specification No. 11: Wet Swales Version 1.8. 2010.

Washington State Department of Ecology. 2005. Stormwater Manual for Western Washington. State of Washington Department of Ecology. Available online at:  
<http://www.ecy.wa.gov/programs/wq/stormwater/manual.html>

### 3.10 Stormwater Ponds

**Definition.** Stormwater ponds are stormwater storage practices that consist of a combination of a permanent pool, micropool, or shallow marsh that promote a good environment for gravitational settling, biological uptake and microbial activity. Ponds are widely applicable for most land uses and are best suited for larger drainage areas. Runoff from each new storm enters the pond and partially displaces pool water from previous storms. The pool also acts as a barrier to re-suspension of sediments and other pollutants deposited during prior storms. When sized properly, stormwater ponds have a residence time that ranges from many days to several weeks, which allows numerous pollutant removal mechanisms to operate. Stormwater ponds can also provide storage above the permanent pool to help meet stormwater management requirements for larger storms. Design variants include:

- P-1 Micropool extended detention pond
- P-2 Wet pond
- P-3 Wet extended detention pond

Stormwater ponds should be considered for use after all other upland retention opportunities have been exhausted and there is still a remaining treatment volume or runoff from larger storms (i.e., 2-year, 15-year or flood control events) to manage.

Stormwater ponds do not receive any stormwater retention value and should be considered only for management of larger storm events. Stormwater ponds have both community and environmental concerns (see Section 3.10.1 Pond Feasibility Criteria) that should be considered before choosing stormwater ponds for the appropriate stormwater practice onsite.

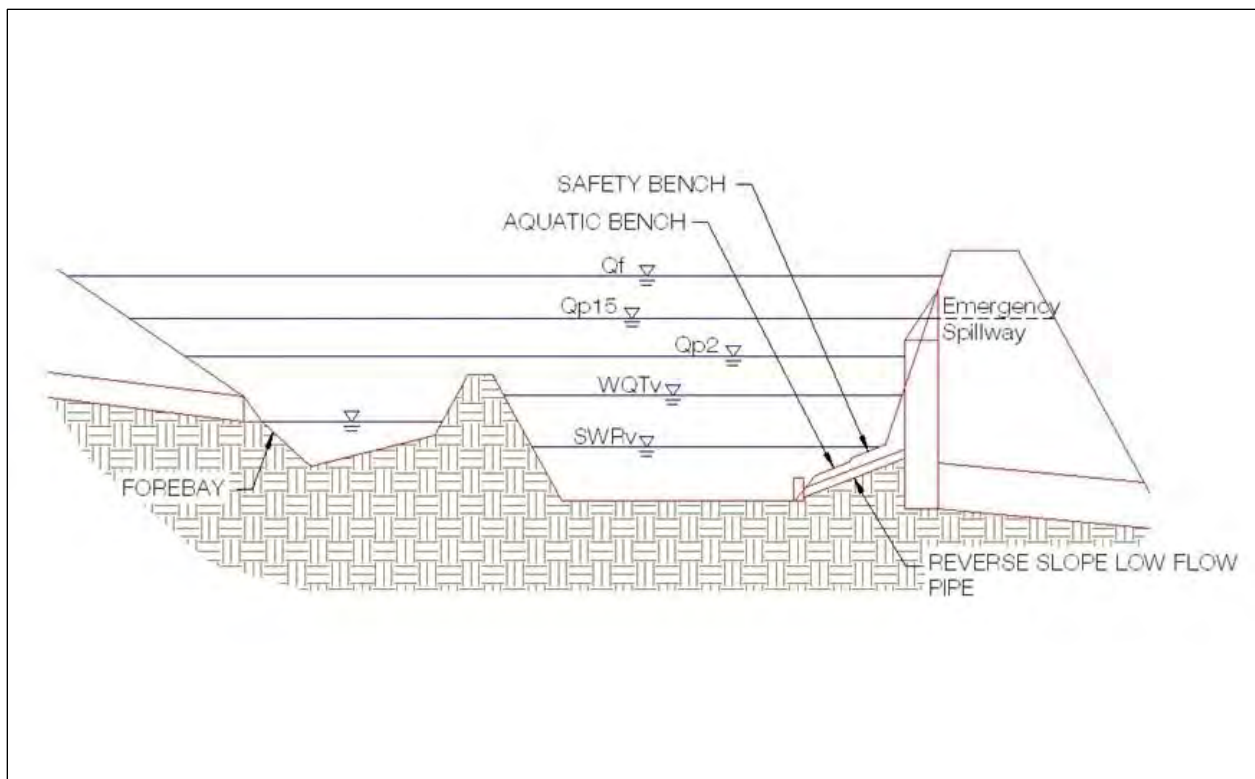
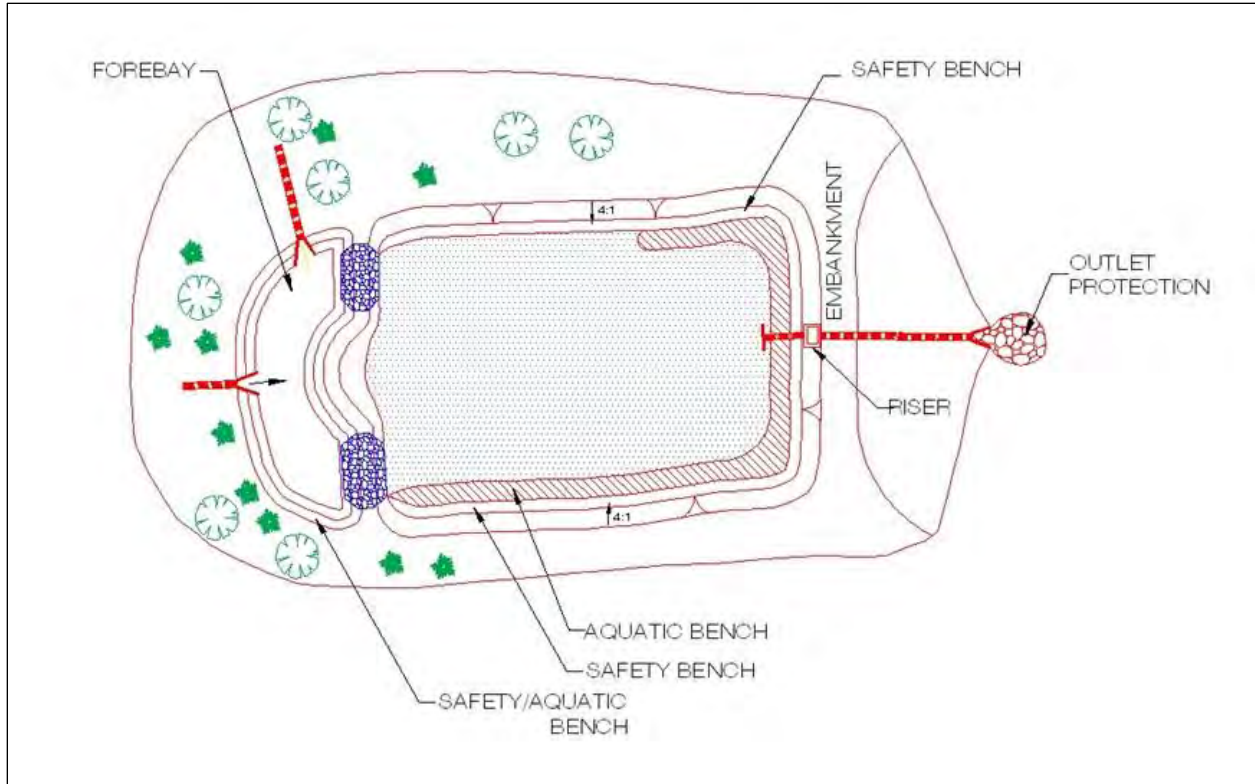


Figure 3.35 Design schematics for a wet pond (P-2).



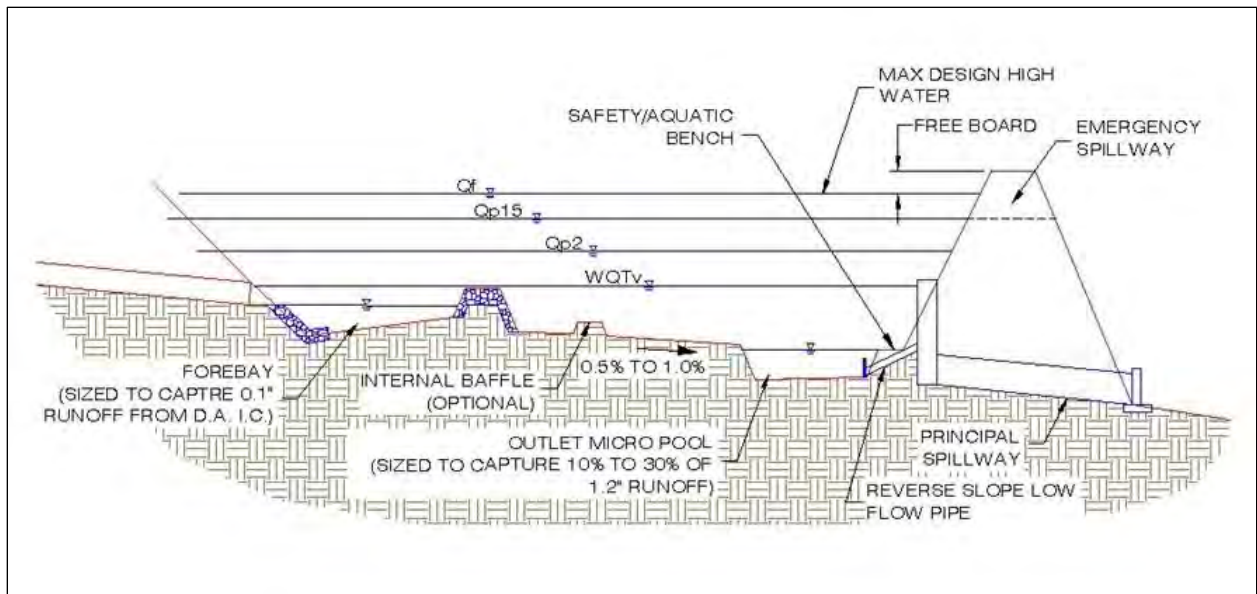
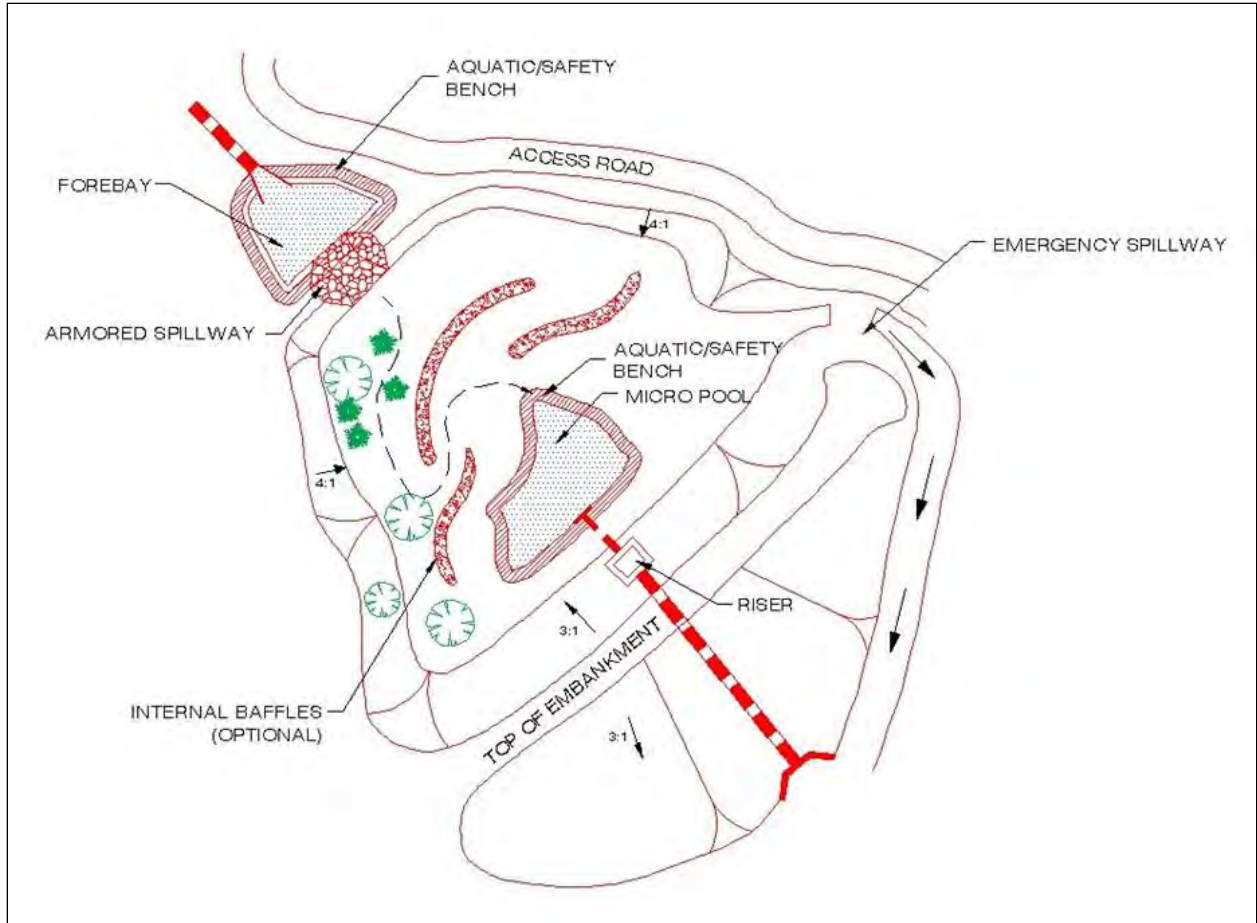


Figure 3.36 Typical extended detention pond (P-3) details.

### 3.10.1 Pond Feasibility Criteria

The following feasibility issues need to be considered when ponds are considered a final stormwater management practice of the treatment train.

**Adequate Water Balance.** Wet ponds must have enough water supplied from groundwater, runoff or baseflow so that the wet pools will not draw down by more than 2 feet after a 30-day summer drought. A simple water balance calculation must be performed using the equation provided in Section 3.10.4. Wetland Design Criteria and Section 3.11.4 Wetland Design Criteria.

**Contributing Drainage Area.** A contributing drainage area of 10 to 25 acres is typically recommended for ponds to maintain constant water elevations. Ponds can still function with drainage areas less than 10 acres, but designers should be aware that these “pocket” ponds will be prone to clogging, experience fluctuating water levels, and generate more nuisance conditions.

**Space Requirements.** The surface area of a pond will normally be at least 1 to 3 percent of its contributing drainage area, depending on the pond’s depth.

**Site Topography.** Ponds are best applied when the grade of contributing slopes is less than 15 percent.

**Available Hydraulic Head.** The depth of a pond is usually determined by the hydraulic head available on the site. The bottom elevation is normally the invert of the existing downstream conveyance system to which the pond discharges. Typically, a minimum of 6 to 8 feet of head are needed to hold the wet pool and any additional large storm storage or overflow capacity for a pond to function.

**Setbacks.** Setback to avoid the risk of seepage, stormwater ponds must not be hydraulically connected to structure foundations. Setbacks to structures must be at least 10 feet and adequate water-proofing protection must be provided for foundations and basements.

**Proximity to Utilities.** For an open pond system, no utility lines shall be permitted to cross any part of the embankment of a wet pool.

**Depth to Water Table.** The depth to the groundwater table is not a major constraint for wetponds because a high water table can help maintain wetland conditions. However, groundwater inputs can also reduce the pollutant removal rates of ponds. Further, if the water table is close to the surface, it may make excavation difficult and expensive.

**Soils.** Highly permeable soils will make it difficult to maintain a healthy permanent pool. Soil infiltration tests need to be conducted at proposed pond sites to determine the need for a pond liner or other method to ensure a constant water surface elevation. Underlying soils of Hydrologic Soil Group (HSG) C or D should be adequate to maintain a permanent pool. Most HSG A soils and some HSG B soils will require a liner (see Table 3.44). Geotechnical tests should be conducted to determine the infiltration rates and other subsurface properties of the soils beneath the proposed pond.

**Use of or Discharges to Natural Wetlands.** Ponds cannot be located within jurisdictional waters, including wetlands, without obtaining a section 404 permit from the appropriate state or

federal regulatory agency. In addition, the designer should investigate the wetland status of adjacent areas to determine if the discharge from the pond will change the hydroperiod of a downstream natural wetland (see Cappiella et al., 2006, for guidance on minimizing stormwater discharges to existing wetlands).

**Perennial Streams.** Locating ponds on perennial streams will require both a Section 401 and Section 404 permit from the appropriate state or federal regulatory agency.

**Community and Environmental Concerns.** Ponds can generate the following community and environmental concerns that need to be addressed during design:

- **Aesthetic Issues.** Many residents feel that ponds are an attractive landscape feature, promote a greater sense of community and are an attractive habitat for fish and wildlife. Designers should note that these benefits are often diminished where ponds are under-sized or have small contributing drainage areas.
- **Existing Forests.** Construction of a pond may involve extensive clearing of existing forest cover. Designers can expect a great deal of neighborhood opposition if they do not make a concerted effort to save mature trees during pond design and construction. In the District of Columbia a permit is required to remove a tree with a circumference greater than 55-inches on private lands. A permit is required to prune or remove any street tree between the sidewalk and the curb. These permits are issued by the District Department of Transportation, Urban Forestry Administration (UFA).
- **Safety Risk.** Pond safety is an important community concern, since both young children and adults have perished by drowning in ponds through a variety of accidents, including falling through thin ice cover. Gentle side slopes and safety benches should be provided to avoid potentially dangerous drop-offs, especially where ponds are located near residential areas.
- **Pollutant Concerns.** Ponds collect and store water and sediment to increase residence time that will increase the likelihood for contaminated water and sediments to be neutralized. However, poorly sized, maintained, and/or functioning ponds can export contaminated sediments and/or water to receiving waterbodies (Mallin, 2000; Mallin et al., 2001; Messersmith, 2007). Further, designers are cautioned that recent research on ponds has shown that some ponds can be hotspots or incubators for algae that generate harmful algal blooms (HABs).
- **Mosquito Risk.** Mosquitoes are not a major problem for larger ponds (Santana et al., 1994; Ladd and Frankenburg, 2003, Hunt et al, 2005). However, fluctuating water levels in smaller or under-sized ponds could pose some risk for mosquito breeding. Mosquito problems can be minimized through simple design features and maintenance operations described in MSSC (2005).
- **Geese and Waterfowl.** Ponds with extensive turf and shallow shorelines can attract nuisance populations of resident geese and other waterfowl, whose droppings add to the nutrient and bacteria loads, thus reducing the removal efficiency for those pollutants. Several design and landscaping features can make ponds much less attractive to geese (see Schueler, 1992).
-

### 3.10.2 Pond Conveyance Criteria

**Internal Slope.** The longitudinal slope of the pond bottom should be at least 0.5 to 1 percent to facilitate maintenance.

**Primary Spillway.** The spillway shall be designed with acceptable anti-flotation, anti-vortex and trash rack devices. The spillway must generally be accessible from dry land. When reinforced concrete pipe is used for the principal spillway to increase its longevity, “O-ring” gaskets (ASTM C361) shall be used to create watertight joints.

**Non-Clogging Low-Flow Orifice.** A low-flow orifice must be provided that is adequately protected from clogging by either an acceptable external trash rack or by internal orifice protection that may allow for smaller diameters. Orifices less than 3 inches in diameter may require extra attention during design, to minimize the potential for clogging.

- One option is a submerged reverse-slope pipe that extends downward from the riser to an inflow point 1 foot below the normal pool elevation.
- Alternative methods must employ a broad crested rectangular V-notch (or proportional) weir, protected by a half-round CMP that extends at least 12 inches below the normal pool elevation.

**Emergency Spillway.** Ponds must be constructed with overflow capacity to pass the 100-year design storm event through either the primary spillway or a vegetated or armored emergency spillway unless waived by DDOE.

**Adequate Outfall Protection.** The design must specify an outfall that will be stable for the 15-year design storm event. The channel immediately below the pond outfall must be modified to prevent erosion and conform to natural dimensions in the shortest possible distance. This is typically done by placing appropriately sized riprap over geotextile fabric, which can reduce flow velocities from the principal spillway to non-erosive levels (3.5 to 5.0 fps) depending on the channel lining material. Flared pipe sections, which discharge at or near the stream invert or into a step pool arrangement, should be used at the spillway outlet.

When the discharge is to a manmade pipe or channel system, the system must be adequate to convey the required design storm peak discharge.

If a pond daylights to a channel with dry weather flow, care should be taken to minimize tree clearing along the downstream channel, and to reestablish a forested riparian zone in the shortest possible distance. Excessive use of rip-rap should be avoided.

The final release rate of the facility shall be modified if any increase in flooding or stream channel erosion would result at a downstream structure, highway, or natural point of restricted streamflow (see Section 2.6 Additional Stormwater Management Requirements).

**Inlet Protection.** Inflow points into the pond must be stabilized to ensure that non-erosive conditions exist during storm events up to the overbank flood event (i.e., the 15-year storm event). Inlet pipe inverts should generally be located at or slightly below the permanent pool

elevation. A forebay shall be provided at each inflow location, unless the inlet is submerged or inflow provides less than 10 percent of the total design storm inflow to the pond.

**Dam Safety Permits.** The designer must verify whether or not Dam Safety permits or approvals are required for the embankment.

### 3.10.3 Pond Pretreatment Criteria

Sediment forebays are considered to be an integral design feature to maintain the longevity of all ponds. A forebay must be located at each major inlet to trap sediment and preserve the capacity of the main treatment cell. The following criteria apply to forebay design:

- A major inlet is defined as an individual storm drain inlet pipe or open channel serving at least 10 percent of the pond's contributing drainage area.
- The forebay consists of a separate cell, formed by an acceptable barrier (e.g., an earthen berm, concrete weir, gabion baskets, etc.).
- The forebay should be between 4 and 6 feet deep and must be equipped with a variable width aquatic bench for safety purposes. The aquatic bench should be 4 to 6 feet wide at a depth of 1 to 2 feet below the water surface. Small forebays may require alternate geometry to achieve the goals of pre-treatment and safety within a small area.
- The forebay shall be sized to contain 0.1 inches of runoff from the contributing drainage impervious area. The relative size of individual forebays should be proportional to the percentage of the total inflow to the pond.
- The bottom of the forebay may be hardened (e.g., with concrete, asphalt, or grouted riprap) to make sediment removal easier.
- The forebay must be equipped with a metered rod in the center of the pool (as measured lengthwise along the low-flow water travel path) for long-term monitoring of sediment accumulation.
- Exit velocities from the forebay shall be non-erosive or an armored overflow shall be provided. Non-erosive velocities are 4 feet per second for the two-year event, and 6 feet per second for the 15-year event.
- Direct maintenance access for appropriate equipment shall be provided to the each forebay.
- The bottom of the forebay may be hardened to make sediment removal easier.

### 3.10.4 Pond Design Criteria

**Pond Storage Design.** The pond permanent pool must be sized to store a volume equivalent to the SWR<sub>v</sub>. Volume storage may be provided in multiple cells. Performance is enhanced when multiple treatment pathways are provided by using multiple cells, longer flowpaths, high surface area to volume ratios, complex microtopography, and/or redundant treatment methods (combinations of pool, ED, and marsh).

**Pond Geometry.** Pond designs should have an irregular shape and a long flow path from inlet to outlet, to increase water residence time and pond performance. The minimum length to width

ratio (i.e., length relative to width) for ponds is 1.5:1. Greater flowpaths and irregular shapes are recommended. Internal berms, baffles, or vegetated peninsulas can be used to extend flow paths and/or create multiple pond cells.

**Permanent Pool Depth.** The maximum depth of the permanent pool should not generally exceed eight feet unless the pond is designed for multiple uses.

**Micropool.** A micropool is a three to six foot deep pool used to protect the low-flow pipe from clogging and to prevent sediment resuspension. For micropool extended detention ponds, the micropool shall be designed to hold at least 10 to 25 percent of the 1.2-inch storm event.

**Side Slopes.** Side slopes for ponds should generally have a gradient no steeper than 3H:1V. Mild slopes promote better establishment and growth of vegetation and provide for easier maintenance and a more natural appearance.

**Maximum Extended Detention Levels.** The total storage, including any ponding for larger flooding events (100-year storm) should not extend more than 5 feet above the pond permanent pool unless specific design enhancements to ensure side slope stability, safety, and maintenance are identified and approved.

**Stormwater Pond Benches.** The perimeter of all pool areas greater than 4 feet in depth must be surrounded by two benches, as follows:

- **Safety Bench.** This is a flat bench located just outside of the perimeter of the permanent pool to allow for maintenance access and reduce safety risks. Except when the stormwater pond side slopes are 5H:1V or flatter, provide a safety bench that generally extends 8 to 15 feet outward from the normal water edge to the toe of the stormwater pond side slope. The maximum slope of the safety bench is 5 percent.
- **Aquatic Bench.** This is a shallow area just inside the perimeter of the normal pool that promotes growth of aquatic and wetland plants. The bench also serves as a safety feature, reduces shoreline erosion, and conceals floatable trash. Incorporate an aquatic bench that generally extends up to 10 feet inward from the normal shoreline, has an irregular configuration, and extends a maximum depth of 18 inches below the normal pool water surface elevation.

**Linings.** When a stormwater pond is located over highly permeable soils or fractured bedrock, a liner may be needed to sustain a permanent pool of water. If geotechnical tests confirm the need for a liner, acceptable options include the following: (1) a clay liner following the specifications outlined in Table 3.44 below; (2) a 30 mil poly-liner; (3) bentonite; (4) use of chemical additives; or (5) an engineering design, as approved on a case-by-case basis by DDOE. A clay liner must have a minimum thickness of 12 inches with an additional 12 inch layer of compacted soil above it, and it must meet the specifications outlined in Table 3.44. Other synthetic liners can be used if the designer can supply supporting documentation that the material will achieve the required performance.

**Table 3.44 Clay Liner Specifications**

Property	Test Method	Unit	Specification
Permeability	ASTM D-2434	cm/s	$1 \times 10^{-6}$
Plasticity Index of Clay	ASTM D-423/424	%	Not less than 15
Liquid Limit of Clay	ASTM D-2216	%	Not less than 30
Clay Particles Passing	ASTM D-422	%	Not less than 30
Clay Compaction	ASTM D-2216	%	95% of standard proctor density

Source DCR (1999): VA

**Required Geotechnical Testing.** Soil borings must be taken below the proposed embankment, in the vicinity of the proposed outlet area, and in at least two locations within the proposed pond treatment area. Soil boring data is needed to (1) determine the physical characteristics of the excavated material, (2) determine its adequacy for use as structural fill or spoil, (3) provide data for structural designs of the outlet works (e.g., bearing capacity and buoyancy), (4) determine compaction/composition needs for the embankment (5) determine the depth to groundwater and bedrock and (6) evaluate potential infiltration losses (and the potential need for a liner).

**Non-clogging Low-Flow (Extended Detention) Orifice.** The low-flow ED orifice shall be adequately protected from clogging by an acceptable external trash rack. The preferred method is a submerged reverse-slope pipe that extends downward from the riser to an inflow point one foot below the normal pool elevation. Alternative methods are to employ a broad crested rectangular, V-notch, or proportional weir, protected by a half-round CMP that extends at least 12 inches below the normal pool.

**Riser in Embankment.** The riser should be located within the embankment for maintenance access, safety, and aesthetics. Access to the riser is to be provided by lockable manhole covers, and manhole steps within easy reach of valves and other controls. The principal spillway opening can be "fenced" with pipe or rebar at 8-inch intervals for safety purposes.

**Trash Racks.** Trash racks shall be provided for low-flow pipes and for riser openings not having anti-vortex devices.

**Pond Drain.** Ponds should have a drainpipe that can completely or partially drain the permanent pool. In cases where a low level drain is not feasible (such as in an excavated pond), a pump well must be provided to accommodate a temporary pump intake when needed to drain the pond.

- The drainpipe must have an upturned elbow or protected intake within the pond to help keep it clear of sediment deposition, and a diameter capable of draining the pond within 24 hours.
- The pond drain must be equipped with an adjustable valve located within the riser, where it will not be normally inundated and can be operated in a safe manner.

Care must be exercised during pond drawdowns to prevent downstream discharge of sediments or anoxic water and rapid drawdown. The approving authority shall be notified before draining a pond.

**Adjustable Gate Valve.** Both the outlet pipe and the pond drain must be equipped with an adjustable gate valve (typically a handwheel activated knife gate valve) or pump well and be sized one pipe size greater than the calculated design diameter. Valves must be located inside of the riser at a point where they (a) will not normally be inundated and (b) can be operated in a safe manner. To prevent vandalism, the handwheel should be chained to a ringbolt, manhole step or other fixed object.

**Safety Features.**

- The principal spillway opening must be designed and constructed to prevent access by small children.
- End walls above pipe outfalls greater than 48 inches in diameter must be fenced to prevent a hazard.
- Storage practices must incorporate an additional 1 foot of freeboard above the emergency spillway, or 2 feet of freeboard if design has no emergency spillway, for the maximum Q<sub>f</sub> design storm unless more stringent Dam Safety requirements apply.
- The emergency spillway must be located so that downstream structures will not be impacted by spillway discharges.
- Both the safety bench and the aquatic bench should be landscaped with vegetation that hinders or prevents access to the pool.
- Warning signs prohibiting swimming must be posted.
- Where permitted, fencing of the perimeter of ponds is discouraged. The preferred method to reduce risk is to manage the contours of the stormwater pond to eliminate drop-offs or other safety hazards. Fencing is required at or above the maximum water surface elevation in the rare situations when the pond slope is a vertical wall.
- Side slopes to the pond shall not be steeper than 3H:1V, and shall terminate on a 15 ft wide safety bench. Both the safety bench and the aquatic bench may be landscaped to prevent access to the pool. The bench requirement may be waived if slopes are 4H:1V or flatter.

**Maintenance Reduction Features.** The following pond maintenance issues can be addressed during the design, in order to make ongoing maintenance easier:

**Maintenance Access.** All ponds must be designed so as to be accessible to annual maintenance. Good access is needed so crews can remove sediments, make repairs and preserve pond treatment capacity.

- Adequate maintenance access must extend to the forebay, safety bench, riser, and outlet structure and must have sufficient area to allow vehicles to turn around.
- The riser should be located within the embankment for maintenance access, safety and aesthetics. Access to the riser should be provided by lockable manhole covers and manhole steps within easy reach of valves and other controls.



- Access roads must (1) be constructed of load-bearing materials or be built to withstand the expected frequency of use, (2) have a minimum width of 15 feet, and (3) have a profile grade that does not exceed 5:1.
- A maintenance right-of-way or easement must extend to the stormwater pond from a public or private road.

**Material Specifications.** ED ponds are generally constructed with materials obtained on-site, except for the plant materials, inflow and outflow devices (e.g., piping and riser materials), possibly stone for inlet and outlet stabilization, and geotextile fabric for lining banks or berms.

**Pond Sizing.** Stormwater ponds can be designed to capture and treat the remaining stormwater discharged from upstream practices from the design storm (SWR<sub>v</sub>). Additionally, stormwater ponds may be sized to control peak flow rates from the 2-year and 15-year frequency storm event or other design storms as required. Design calculations must ensure that the post-development peak discharge does not exceed the pre-development peak discharge. See Section 2.7 Hydrology Methods for a summary of acceptable hydrological methodologies and models.

For treatment train designs where upland practices are utilized for treatment of the SWR<sub>v</sub>, designers can use a site-adjusted R<sub>v</sub> or CN that reflects the volume reduction of upland practices to compute the Q<sub>p2</sub> and Q<sub>p15</sub> that must be treated by the stormwater pond.

The pond permanent pool must be sized to store a volume equivalent to the SWR<sub>v</sub> or design volume.

The storage volume (S<sub>v</sub>) of the practice is equal to the volume provided by the pond permanent pool (Equation 3.23). The total S<sub>v</sub> cannot exceed the design SWR<sub>v</sub>.

**Equation 3.23 Pond Storage Volume**

$$S_v = \text{Pond permanent pool volume}$$

**Water Balance Testing.** A water balance calculation is recommended to document that sufficient inflows to wet ponds and wet ED ponds exist to compensate for combined infiltration and evapo-transpiration losses during a 30-day summer drought without creating unacceptable drawdowns (see Equation 3.24, adapted from Hunt et al., 2007). The recommended minimum pool depth to avoid nuisance conditions may vary; however, it is generally recommended that the water balance maintain a minimum 24-inch reservoir.

**Equation 3.24 Water Balance Equation for Acceptable Water Depth in a Wet Pond**

$$DP > ET + INF + RES - MB$$

where:

<i>DP</i>	=	average design depth of the permanent pool (in.)
<i>ET</i>	=	summer evapo-transpiration rate (in.) (assume 8 in.)
<i>INF</i>	=	monthly infiltration loss (assume 7.2 at 0.01 in./hour)
<i>RES</i>	=	reservoir of water for a factor of safety (assume 24 in.)
<i>MB</i>	=	measured baseflow rate to the pond, if any convert to pond-inches (in.)

Design factors that will alter this equation are the measurements of seasonal base flow and infiltration rate. The use of a liner could eliminate or greatly reduce the influence of infiltration. Similarly, land use changes in the upstream watershed could alter the base flow conditions over time (e.g., urbanization and increased impervious cover).

Translating the baseflow to inches refers to the depth within the pond. Therefore, Equation 3.25 can be used to convert the baseflow, measured in cubic feet per second (cfs), to pond-inches:

**Equation 3.25 Baseflow Conversion**

$$Pond - inches = \frac{MB \times 2.592 \times 10^6 \times 12}{SA}$$

where:

<i>pond-inches</i>	=	depth within the pond (in.)
<i>MB</i>	=	measured baseflow rate to the pond (cfs)
$2.592 \times 10^6$	=	conversion factor from cfs to ft <sup>3</sup> /month
12	=	conversion from feet to inches
<i>SA</i>	=	surface area of pond (ft <sup>2</sup> )

**3.10.5 Pond Landscaping Criteria**

**Pond Benches.** The perimeter of all deep pool areas (four feet or greater in depth) must be surrounded by two benches:

- A safety bench that extends 8 to 15 feet outward from the normal water edge to the toe of the pond side slope. The maximum slope of the safety bench shall be 6 percent.
- An aquatic bench that extends up to 10 feet inward from the normal shoreline and has a maximum depth of 18 inches below the normal pool water surface elevation.

**Landscaping and Planting Plan.** A landscaping plan must be provided that indicates the methods used to establish and maintain vegetative coverage in the pond and its buffer (see Section 3.6.5 Bioretention Landscaping Criteria for extended landscaping and planting details). Minimum elements of a landscaping plan include the following:

- Delineation of pondscaping zones within both the pond and buffer
- Selection of corresponding plant species
- The planting plan
- The sequence for preparing the wetland benches (including soil amendments, if needed)
- Sources of native plant material
- The landscaping plan should provide elements that promote diverse wildlife and waterfowl use within the stormwater wetland and buffers.
- Woody vegetation may not be planted or allowed to grow within 15 feet of the toe of the embankment nor within 25 feet from the principal spillway structure.
- A vegetated buffer should be provided that extends at least 25 feet outward from the maximum water surface elevation of the pond. Permanent structures (e.g., buildings) should not be constructed within the buffer area. Existing trees should be preserved in the buffer area during construction.
- The soils in the stormwater buffer area are often severely compacted during the construction process, to ensure stability. The density of these compacted soils can be so great that it effectively prevents root penetration and, therefore, may lead to premature mortality or loss of vigor. As a rule of thumb, planting holes should be three times deeper and wider than the diameter of the root ball for ball-and-burlap stock, and five times deeper and wider for container-grown stock.
- Avoid species that require full shade, or are prone to wind damage. Extra mulching around the base of trees and shrubs is strongly recommended as a means of conserving moisture and suppressing weeds.

For more guidance on planting trees and shrubs in pond buffers, consult Cappiella et al (2006).

### 3.10.6 Pond Construction Sequence

The following is a typical construction sequence to properly install a stormwater pond. The steps may be modified to reflect different pond designs, site conditions, and the size, complexity and configuration of the proposed facility.

**Step 1: Use of Ponds for Erosion and Sediment Control.** A pond may serve as a sediment basin during project construction. If this is done, the volume should be based on the more stringent sizing rule (erosion and sediment control requirement vs. storage volume requirement). Installation of the permanent riser should be initiated during the construction phase, and design elevations should be set with final cleanout of the sediment basin and conversion to the post-construction pond in mind. The bottom elevation of the pond should be lower than the bottom elevation of the temporary sediment basin. Appropriate procedures must be implemented to prevent discharge of turbid waters when the basin is being converted into a pond.

Approval from DDOE must be obtained before any sediment pond can be used as for stormwater management.

**Step 2: Stabilize the Drainage Area.** Ponds should only be constructed after the contributing drainage area to the pond is completely stabilized. If the proposed pond site will be used as a sediment trap or basin during the construction phase, the construction notes should clearly indicate that the facility will be de-watered, dredged and re-graded to design dimensions after the original site construction is complete.

**Step 3: Assemble Construction Materials On-site,** make sure they meet design specifications, and prepare any staging areas.

**Step 4: Clear and Strip** the project area to the desired sub-grade.

**Step 5:** Install Erosion and Sediment Controls prior to construction, including temporary de-watering devices and stormwater diversion practices. All areas surrounding the pond that are graded or denuded during construction must be planted with turf grass, native plantings, or other approved methods of soil stabilization.

**Step 6: Excavate the Core Trench and Install the Spillway Pipe.**

**Step 7: Install the Riser or Outflow Structure** and ensure the top invert of the overflow weir is constructed level at the design elevation.

**Step 8: Construct the Embankment and any Internal Berms** in 8- to 12-inch lifts, compact the lifts with appropriate equipment.

**Step 9: Excavate/Grade** until the appropriate elevation and desired contours are achieved for the bottom and side slopes of the pond.

**Step 10: Construct the Emergency Spillway** in cut or structurally stabilized soils.

**Step 11: Install Outlet Pipes,** including downstream rip-rap apron protection.

**Step 12: Stabilize Exposed Soils** with temporary seed mixtures appropriate for the pond buffer. All areas above the normal pool elevation should be permanently stabilized by hydroseeding or seeding over straw.

**Step 13: Plant the Pond Buffer Area** according to the pondscaping plan (see Section 3.10.5 Pond Landscaping Criteria).

**Construction Supervision.** Supervision during construction is recommended to ensure that stormwater ponds are properly constructed, especially during the following stages of construction:

- Preconstruction meeting
- Initial site preparation (including installation of E&S controls)
- Excavation/Grading (interim and final elevations)
- Installation of the embankment, the riser/primary spillway, and the outlet structure
- Implementation of the pondscaping plan and vegetative stabilization
- Final inspection (develop a punch list for facility acceptance)

DDOE's construction phase inspection checklist for ponds can be found in Appendix L.

To facilitate maintenance, contractors should measure the actual constructed pond depth at three areas within the permanent pool (forebay, mid-pond and at the riser), and they should mark and geo-reference them on an as-built drawing. This simple data set will enable maintenance inspectors to determine pond sediment deposition rates in order to schedule sediment cleanouts.

### 3.10.7 Pond Maintenance Criteria

Maintenance is needed so stormwater ponds continue to operate as designed on a long-term basis. Ponds normally have fewer routine maintenance requirements than other stormwater control measures. Stormwater pond maintenance activities vary regarding the level of effort and expertise required to perform them. Routine stormwater pond maintenance, such as mowing and removing debris and trash, is needed several times each year (see Table 3.45). More significant maintenance (e.g., removing accumulated sediment) is needed less frequently but requires more skilled labor and special equipment. Inspection and repair of critical structural features (e.g., embankments and risers) needs to be performed by a qualified professional (e.g., a structural engineer) who has experience in the construction, inspection, and repair of these features.

Sediment removal in the pond pretreatment forebay should occur every 5 to 7 years or after 50 percent of total forebay capacity has been lost. The designer should also check to see whether removed sediments can be spoiled on-site or must be hauled away. Sediments excavated from ponds are not usually considered toxic or hazardous. They can be safely disposed of by either land application or land filling. Sediment testing may be needed prior to sediment disposal if the pond serves a hotspot land use.

**Table 3.45 Pond Maintenance Tasks and Frequency**

Frequency	Maintenance Items
During establishment, as needed (first year)	<ul style="list-style-type: none"> <li>▪ Inspect the site at least twice after storm events that exceed a 1/2-inch of rainfall.</li> <li>▪ Plant the aquatic benches with emergent wetland species, following the planting recommendations contained in Section 3.11.6 Wetland Landscaping Criteria.</li> <li>▪ Stabilize any bare or eroding areas in the contributing drainage area or around the pond buffer</li> <li>▪ Water trees and shrubs planted in the pond buffer during the first growing season. In general, consider watering every 3 days for first month, and then weekly during the remainder of the first growing season (April - October), depending on rainfall.</li> </ul>
Quarterly or after major storms (>1 inch of rainfall)	<ul style="list-style-type: none"> <li>▪ Mowing – twice a year</li> <li>▪ Remove debris and blockages</li> <li>▪ Repair undercut, eroded, and bare soil areas</li> </ul>
Twice a year	<ul style="list-style-type: none"> <li>▪ Mowing of the buffer and pond embankment</li> </ul>
Annually	<ul style="list-style-type: none"> <li>▪ Shoreline cleanup to remove trash, debris and floatables</li> <li>▪ A full maintenance inspection</li> <li>▪ Open up the riser to access and test the valves</li> <li>▪ Repair broken mechanical components, if needed</li> </ul>
Once—during the second year following construction	<ul style="list-style-type: none"> <li>▪ Pond buffer and aquatic bench reinforcement plantings</li> </ul>

Frequency	Maintenance Items
Every 5 to 7 years	<ul style="list-style-type: none"> <li>▪ Forebay Sediment Removal</li> </ul>
From 5 to 25 years	<ul style="list-style-type: none"> <li>▪ Repair pipes, the riser and spillway, as needed</li> </ul>

**Maintenance Plans.** Maintenance plans must clearly outline how vegetation in the pond and its buffer will be managed or harvested in the future. Periodic mowing of the stormwater buffer is only required along maintenance rights-of-way and the embankment. The remaining buffer can be managed as a meadow (mowing every other year) or forest. The maintenance plan should schedule a shoreline cleanup at least once a year to remove trash and floatables.

**Maintenance Inspections.** Maintenance of a pond is driven by annual inspections by a qualified professional that evaluate the condition and performance of the pond. Based on inspection results, specific maintenance tasks will be triggered.

DDOE’s maintenance inspection checklist for stormwater ponds can be found in Appendix M.

**Declaration of Covenants.** A declaration of covenants that includes all maintenance responsibilities to ensure the continued stormwater performance for the BMP is required. The declaration of covenants specifies the property owner’s primary maintenance responsibilities, and authorizes DDOE staff to access the property for inspection or corrective action in the event the proper maintenance is not performed. The declaration of covenants is attached to the deed of the property. An example form is provided at the end of Chapter 5 though variations will exist for scenarios where stormwater crosses property lines. The covenant is between the property and the District Government. It is submitted through the Office of the Attorney General (OAG). All SWMPs have a maintenance agreement stamp that must be signed for a building permit to proceed. A maintenance schedule must appear on the SWMP. Additionally, a maintenance schedule is required in schedule c of the declaration of covenants.

Covenants are not required on government properties, but maintenance responsibilities must be defined through a partnership agreement or a memorandum of understanding.

**Waste Material.** Waste material from the repair, maintenance, or removal of a BMP or land cover shall be removed and disposed of in compliance with applicable federal and District law.

### 3.10.8 Pond Stormwater Compliance Calculations

Stormwater ponds receive 10 percent retention value and are an accepted TSS removal practice for the amount of storage volume (Sv) provided by the BMP (Table 3.46).

**Table 3.46 Pond Retention Value and Pollutant Removal**

Retention Value	= 0.1 × Sv
Accepted TSS Treatment Practice	Yes

### 3.10.9 References

- Cappiella, K., T. Schueler and T. Wright. 2006. Urban Watershed Forestry Manual: Part 2: Conserving and Planting Trees at Development Sites. USDA Forest Service. Center for Watershed Protection. Ellicott City, MD.
- Hunt, W., C. Apperson, and W. Lord. 2005. "Mosquito Control for Stormwater Facilities." Urban Waterways. North Carolina State University and North Carolina Cooperative Extension. Raleigh, NC.
- Hunt, W., M. Burchell, J. Wright and K. Bass. 2007. "Stormwater Wetland Design Update: Zones, Vegetation, Soil and Outlet Guidance." Urban Waterways. North Carolina State Cooperative Extension Service. Raleigh, NC.
- Ladd, B and J. Frankenburg. 2003. Management of Ponds, Wetlands and Other Water Reservoirs. Purdue Extension. WQ-41-W.
- Mallin, M. 2000. Effect of human development on bacteriological water quality in coastal watersheds. *Ecological Applications* 10(4):1047-1056.
- Mallin, M.A., S.H. Ensign, Matthew R. McIver, G. Christopher Shank, and Patricia K. Fowler. 2001. Demographic, landscape, and meteorological factors controlling the microbial pollution of coastal waters. *Hydrobiologia* 460(1-3):185-193.
- Messersmith, M.J. 2007. Assessing the hydrology and pollutant removal efficiencies of wet detention ponds in South Carolina. MS. Charleston, S.C. College of Charleston, Master of Environmental Studies.
- Minnesota Stormwater Steering Committee (MSSC). 2005. Minnesota Stormwater Manual. Emmons & Oliver Resources, Inc. Minnesota Pollution Control Agency. St. Paul, MN.
- Santana, F., J. Wood, R. Parsons, and S. Chamberlain. 1994. Control of Mosquito Breeding in Permitted Stormwater Systems. Southwest Florida Water Management District. Brooksville, FL.
- Schueler, T, 1992. Design of Stormwater Wetland Systems. Metropolitan Washington Council of Governments. Washington, DC.
- Virginia DCR Stormwater Design Specification No. 14: Wet Ponds Version 1.8. 2010.
- Virginia DCR Stormwater Design Specification No. 15: Extended Detention (ED) Pond Version 1.8. 2010.
- VA Department of Conservation and Recreation (VA DCR). 1999. Virginia Stormwater Management Handbook, first edition.

### 3.11 Stormwater Wetlands

**Definition.** Practices that create shallow marsh areas to treat urban stormwater which often incorporate small permanent pools and/or extended detention storage. Stormwater wetlands are explicitly designed to provide stormwater detention for larger storms (2-year, 15-year or flood control events) above the design storm (Stormwater Retention Volume (SWRv)) storage. Design variants include:

W-1 shallow wetland

W-2 extended detention shallow wetland

Stormwater wetlands, sometimes called constructed wetlands, are shallow depressions that receive stormwater inputs for water quality treatment. Wetlands are typically less than 1 foot deep (although they have greater depths at the forebay and in micropools) and possess variable microtopography to promote dense and diverse wetland cover. Runoff from each new storm displaces runoff from previous storms, and the long residence time allows multiple pollutant removal processes to operate. The wetland environment provides an ideal environment for gravitational settling, biological uptake, and microbial activity.

Stormwater wetlands should be considered for use after all other upland retention opportunities have been exhausted and there is still a remaining treatment volume or runoff from larger storms (i.e., 2-year, 15-year or flood control events) to manage.

Stormwater wetlands do not receive any stormwater retention value and should be considered only for management of larger storm events. Stormwater wetlands have both community and environmental concerns (see Section 3.10.1 Pond Feasibility Criteria) that should be considered before choosing stormwater ponds for the appropriate stormwater practice onsite.

*Important Note: All of the pond performance criteria presented in Section 3.10 also apply to the design of stormwater wetlands. Additional criteria that govern the geometry and establishment of created wetlands are presented in this section.*



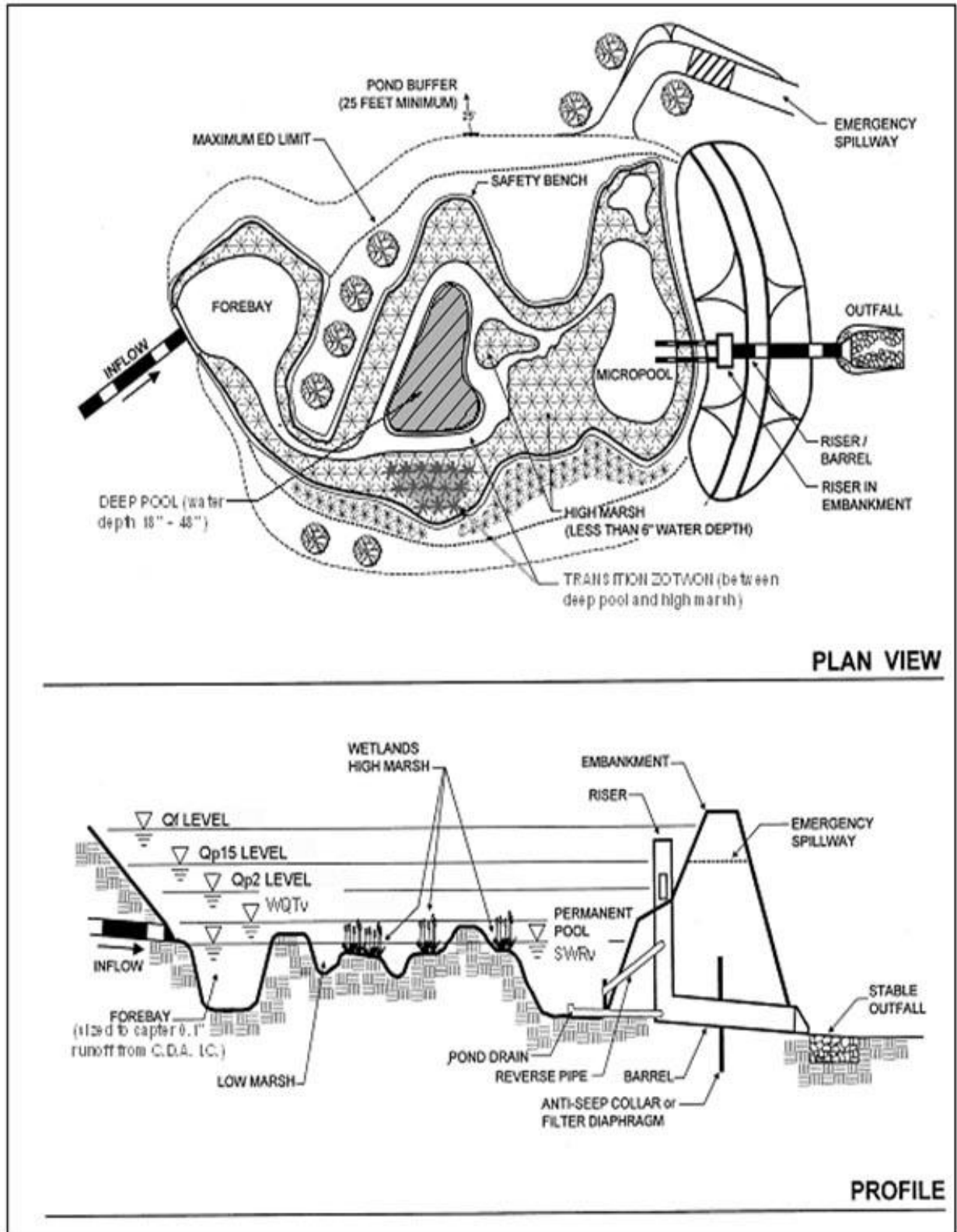


Figure 3.37 Example of extended detention shallow wetland.

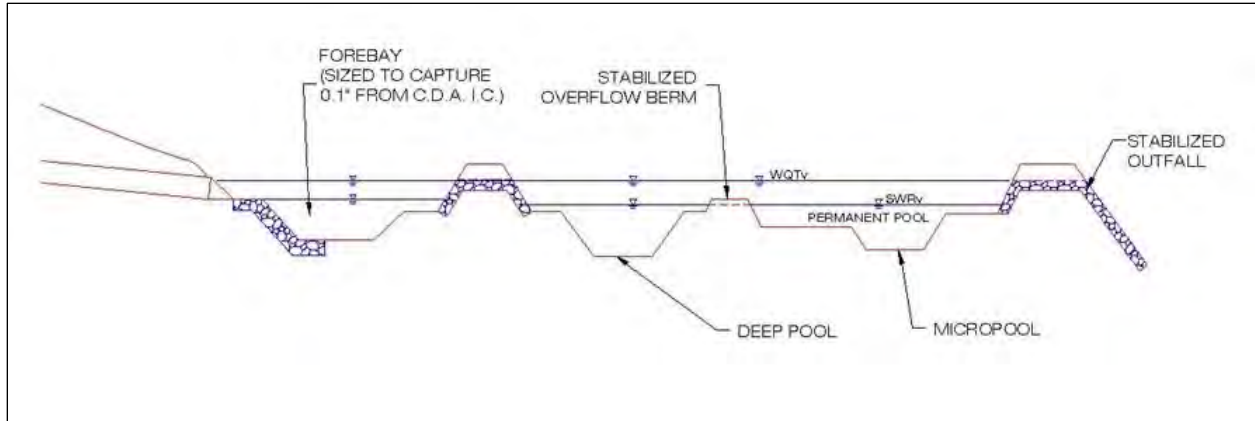


Figure 3.38 Cross section of a typical stormwater wetland.

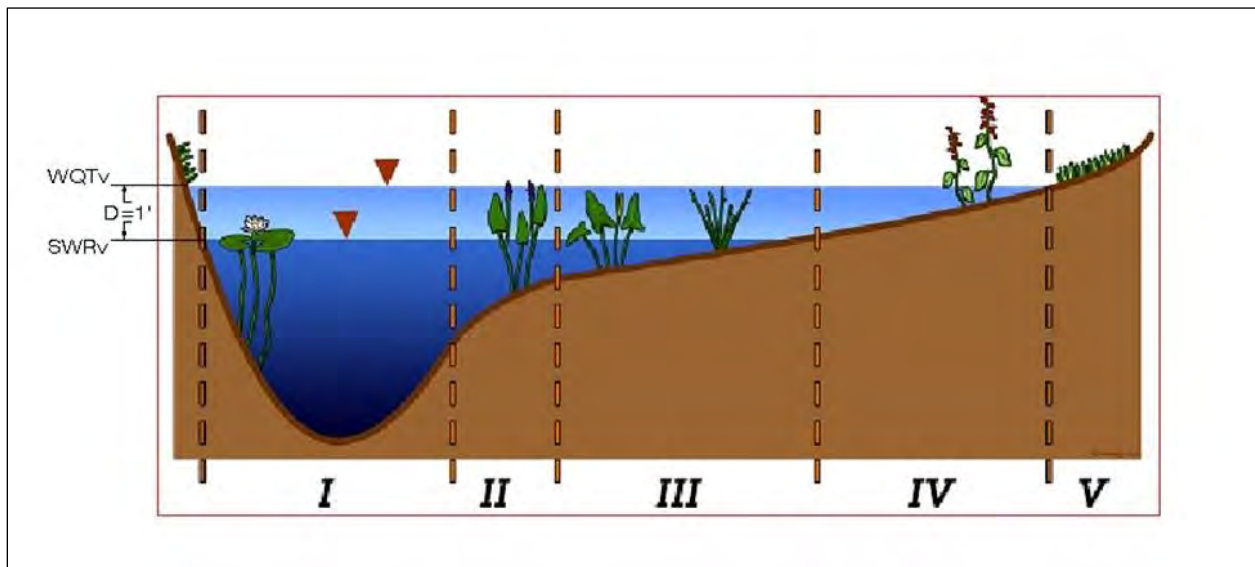


Figure 3.39 Interior wetland zones: (I) Deep Pool (depth -48 to -18 inches), (II) Transition Zone (depth -18 to -6 inches), (III and IV) High Marsh Zone (depth -6 to +6 inches), (IV) Temporary Inundation Area, and (V) Upper Bank (adapted from Hunt et al, 2007).

### 3.11.1 Wetland Feasibility Criteria

Constructed wetland designs are subject to the following site constraints:

**Adequate Water Balance.** Wetlands must have enough water supplied from groundwater, runoff or baseflow so that the permanent pools will not draw down by more than 2 feet after a 30-day summer drought. A simple water balance calculation must be performed using the equation provided in Section 3.11.4. Wetland Design Criteria.

**Contributing Drainage Area (CDA).** The contributing drainage area must be large enough to sustain a permanent water level within the stormwater wetland. If the only source of wetland hydrology is stormwater runoff, then several dozen acres of drainage area are typically needed to maintain constant water elevations. Smaller drainage areas are acceptable if the bottom of the wetland intercepts the groundwater table or if the designer or approving agency is willing to accept periodic wetland drawdown.

**Space Requirements.** Constructed wetlands normally require a footprint that takes up about 3 percent of the contributing drainage area, depending on the average depth of the wetland and the extent of its deep pool features.

**Site Topography.** Wetlands are best applied when the grade of contributing slopes is less than 8 percent.

**Steep Slopes.** A modification of the Constructed Wetland (and linear wetland or wet swale system) is the Regenerative Stormwater Conveyance (RSC) or Step Pool Storm Conveyance channel. The RSC can be used to bring stormwater down steeper grades through a series of step pools. This can serve to bring stormwater down outfalls where steep drops on the edge of the tidal receiving system can create design challenges. For more information on RSC systems, designers can consult the Anne

Arundel County Design Specifications are available at  
<http://www.aacounty.org/DPW/Watershed/StepPoolStormConveyance.cfm>

**Available Hydraulic Head.** The depth of a constructed wetland is usually constrained by the hydraulic head available on the site. The bottom elevation is fixed by the elevation of the existing downstream conveyance system to which the wetland will ultimately discharge. Because constructed wetlands are typically shallow, the amount of head needed (usually a minimum of 2 to 4 feet) is typically less than for wet ponds.

**Setbacks.** To avoid the risk of seepage, stormwater wetlands must not be hydraulically connected to structure foundations. Setbacks to structures must be at least 10 feet and adequate water-proofing protection must be provided for foundations and basements.

**Depth to Water Table.** The depth to the groundwater table is not a major constraint for constructed wetlands, since a high water table can help maintain wetland conditions. However, designers should keep in mind that high groundwater inputs may increase excavation costs (refer to Section 3.10 Stormwater Ponds).

**Soils.** Soil tests should be conducted to determine the infiltration rates and other subsurface properties of the soils underlying the proposed wetland. Highly permeable soils will make it difficult to maintain a healthy permanent pool. Underlying soils of Hydrologic Soil Group (HSG) C or D should be adequate to maintain a permanent pool. Most HSG A soils and some HSG B soils will require a liner (see Table 3.44).

**Use of or Discharges to Natural Wetlands.** Constructed wetlands may not be located within jurisdictional waters, including wetlands, without obtaining a Section 404 permit from the appropriate federal regulatory agency. In addition, designer should investigate the status of

adjacent wetlands to determine if the discharge from the constructed wetland will change the hydroperiod of a downstream natural wetland (see Cappiella et al., 2006 for guidance on minimizing stormwater discharges to existing wetlands).

**Regulatory Status.** Constructed wetlands built for the express purpose of stormwater treatment are generally not considered jurisdictional wetlands.

**Perennial Streams.** Locating a constructed wetland along or within a perennial stream will require both Section 401 and Section 404 permits from the state or federal regulatory authority.

**Community and Environmental Concerns.** In addition to the community and environmental concerns that exist for stormwater ponds, stormwater wetlands can generate the following to be addressed during design:

- **Aesthetics and Habitat.** Constructed wetlands can create wildlife habitat and can also become an attractive community feature. Designers should think carefully about how the wetland plant community will evolve over time, since the future plant community seldom resembles the one initially planted.
- **Existing Forests.** Given the large footprint of a constructed wetland, there is a strong chance that the construction process may result in extensive tree clearing. The designer should preserve mature trees during the facility layout, and he/she may consider creating a wooded wetland (see Cappiella et al., 2006). In the District of Columbia a permit is required to remove a tree with a circumference greater than 55-inches on private lands. A permit is required to prune or remove any street tree between the sidewalk and the curb. These permits are issued by the District Department of Transportation, Urban Forestry Administration (UFA).
- **Safety Risk.** Constructed wetlands are safer than other types of ponds, although forebays and micropools must be designed with aquatic benches to reduce safety risks.
- **Mosquito Risk.** Mosquito control can be a concern for stormwater wetlands if they are under-sized or have a small contributing drainage area. Deepwater zones serve to keep mosquito populations in check by providing habitat for fish and other pond life that prey on mosquito larvae. Few mosquito problems are reported for well designed, properly sized and frequently maintained constructed wetlands; however, no design can eliminate them completely. Simple precautions can be taken to minimize mosquito breeding habitat within constructed wetlands (e.g., constant inflows, benches that create habitat for natural predators, and constant pool elevations—MSSC, 2005).

### 3.11.2 Wetland Conveyance Criteria

- The slope profile within individual wetland cells should generally be flat from inlet to outlet (adjusting for microtopography). The recommended maximum elevation drop between wetland cells is 1 foot or less.
- Since most constructed wetlands are on-line facilities, they need to be designed to safely pass the maximum design storm (e.g., the 15-year and 100-year design storms). While the ponding depths for the more frequent 2-year storm are limited in order to avoid adverse

impacts to the planting pallet, the overflow for the less frequent 15- and 100-year storms must likewise be carefully designed to minimize the depth of ponding. A maximum depth of 4 feet over the wetland pool is recommended.

- While many different options are available for setting the normal pool elevation, it is strongly recommended that removable flashboard risers be used, given their greater operational flexibility to adjust water levels following construction (see Hunt et al, 2007). Also, a weir can be designed to accommodate passage of the larger storm flows at relatively low ponding depths.

### 3.11.3 Wetland Pretreatment Criteria

Sediment regulation is critical to sustain stormwater wetlands. Consequently, a forebay shall be located at the inlet, and a micropool shall be located at the outlet (A micropool is a three to six foot deep pool used to protect the low-flow pipe from clogging and to prevent sediment resuspension). Forebays are designed in the same manner as stormwater ponds (see Section 3.10.3 Pond Pretreatment Criteria). The design of forebays should consider the possibility of heavy trash loads from public areas.

### 3.11.4 Wetland Design Criteria

**Internal Design Geometry.** Research and experience have shown that the internal design geometry and depth zones are critical in maintaining the pollutant removal capability and plant diversity of stormwater wetlands. Wetland performance is enhanced when the wetland has multiple cells, longer flowpaths, and a high ratio of surface area to volume. Whenever possible, constructed wetlands should be irregularly shaped with long, sinuous flow paths. The following design elements are required for stormwater wetlands:

**Multiple-Cell Wetlands.** Wetlands can be divided into at least four internal sub-cells of different elevations: the forebay, a micro-pool outlet, and two additional cells. Cells can be formed by sand berms (anchored by rock at each end), back-filled coir fiber logs, or forested peninsulas (extending as wedges across 95 percent of the wetland width). The vegetative target is to ultimately achieve a 50-50 mix of emergent and forested wetland vegetation within all four cells.

The first cell (the forebay) is deeper and is used to receive runoff from the pond cell or the inflow from a pipe or open channel and distribute it as sheetflow into successive wetland cells. The surface elevation of the second cell is the normal pool elevation. It may contain a forested island or a sand wedge channel to promote flows into the third cell, which is 3 to 6 inches lower than the normal pool elevation. The purpose of the wetland cells is to create an alternating sequence of aerobic and anaerobic conditions to maximize pollutant removal. The fourth wetland cell is located at the discharge point and serves as a micro-pool with an outlet structure or weir.

**Extended Detention Ponding Depth.** When extended detention is provided for management of larger storm events, the total ED volume shall not comprise more than 50 percent of the total volume stored by the wetland, and its maximum water surface elevation shall not extend more than three feet above the normal pool.

**Deep Pools.** Approximately 25 percent of the wetland surface area must be provided in at least three deeper pools—located at the inlet (forebay), center, and outlet (micropool) of the wetland—with each pool having a depth of from 18 to 48 inches. Refer to the sizing based on water balance below for additional guidance on the minimum depth of the deep pools.

**High Marsh Zone.** Approximately 70 percent of the wetland surface area must exist in the high marsh zone (-6 inches to +6 inches, relative to the normal pool elevation).

**Transition Zone.** The low marsh zone is no longer an acceptable wetland zone, and is only allowed as a short transition zone from the deeper pools to the high marsh zone (-6 to -18 inches below the normal pool elevation). In general, this transition zone should have a maximum slope of 5H:1V (or preferably flatter) from the deep pool to the high marsh zone. It is advisable to install biodegradable erosion control fabrics or similar materials during construction to prevent erosion or slumping of this transition zone.

**Flow Path.** In terms of the flow path, there are two design objectives:

- The overall flow path through the wetland can be represented as the length-to-width ratio OR the flow path ratio. A minimum overall flow path of 2:1 must be provided across the stormwater wetland.
- The shortest flow path represents the distance from the closest inlet to the outlet. The ratio of the shortest flow path to the overall length must be at least 0.5. In some cases – due to site geometry, storm sewer infrastructure, or other factors—some inlets may not be able to meet these ratios. However, the drainage area served by these “closer” inlets must constitute no more than 20 percent of the total contributing drainage area.

**Side Slopes.** Side slopes for the wetland should generally have gradients of 4H:1V or flatter. These mild slopes promote better establishment and growth of the wetland vegetation. They also contribute to easier maintenance and a more natural appearance.

**Micro-Topographic Features.** Stormwater wetlands must have internal structures that create variable micro-topography, which is defined as a mix of above-pool vegetation, shallow pools, and deep pools that promote dense and diverse vegetative cover.

**Constructed Wetland Material Specifications.** Wetlands are generally constructed with materials obtained on-site, except for the plant materials, inflow and outflow devices (e.g., piping and riser materials), possibly stone for inlet and outlet stabilization, and geotextile fabric for lining banks or berms. Plant stock should be nursery grown, unless otherwise approved, and must be healthy and vigorous native species free from defects, decay, disfiguring roots, sunscald, injuries, abrasions, diseases, insects, pests, and all forms of infestations or objectionable disfigurements, as determined by DDOE.

**Wetland Sizing.** Constructed wetlands can be designed to capture and treat the remaining stormwater discharged from upstream practices from the design storm (SWR<sub>v</sub>). Additionally, wetlands can be sized to control peak flow rates from the 2-year and 15-year frequency storm event or other design storm. Design calculations must ensure that the post-development peak

discharge does not exceed the pre-development peak discharge. See Section 2.7 Hydrology Methods for a summary of acceptable hydrological methodologies and models.

For treatment train designs where upland practices are utilized for treatment of the SWRV, designers can use a site-adjusted Rv or CN that reflects the volume reduction of upland practices to compute the Qp2 and Qp15 that must be treated by the wetland.

The wetland permanent pools (volume stored in deep pools and pool depths) must be sized to store a volume equivalent to the SWRV or design volume.

The storage volume (Sv) of the practice is equal to the volume provided by the wetland permanent pool (Equation 3.26). The total Sv cannot exceed the SWRV.

**Equation 3.26 Wetland Storage Volume**

$$S_v = \text{Wetland permanent pool volume}$$

**Sizing for Minimum Pool Depth.** Initially, it is recommended that there be no minimum drainage area requirement for the system, although it may be necessary to calculate a water balance for the wet pond cell when its CDA is less than 10 acres (Refer to Section 3.10 Stormwater Ponds).

Similarly, if the hydrology for the constructed wetland is not supplied by groundwater or dry weather flow inputs, a simple water balance calculation must be performed, using Equation 3.27 (Hunt et al., 2007), to assure the deep pools will not go completely dry during a 30 day summer drought.

**Equation 3.27 Water Balance for Acceptable Water Depth in a Stormwater Wetland**

$$DP = \left( RF_m \times EF \times \frac{WS}{WL} \right) - (ET - INF - RS)$$

where:

- DP* = depth of pool (in.)
- RF<sub>m</sub>* = monthly rainfall during drought (in.)
- EF* = fraction of rainfall that enters the stormwater wetland (in.)  
(CDA × Rv)
- WS/WL* = ratio of contributing drainage area to wetland surface area
- ET* = summer evapotranspiration rate (in.) (assume 8 in.)
- INF* = monthly infiltration loss (assume 7.2 inches at 0.01 in./hr)
- RES* = reservoir of water for a factor of safety (assume 6 in.)

Using Equation 3.28, setting the groundwater and (dry weather) base flow to zero and assuming a worst case summer rainfall of 0 inches, the minimum depth of the pool calculates as follows (Equation 3.28):

**Equation 3.28 Minimum Depth of the Permanent Pool**

$$\text{Depth of Pool (DP)} = 0 \text{ in. (RF}_m\text{)} - 8 \text{ in. (ET)} - 7.2 \text{ in. (INF)} - 6 \text{ in. (RES)} = 21.2 \text{ in.}$$

Therefore, unless there is other input, such as base flow or groundwater, the minimum depth of the pool should be at least 22 inches (rather than the 18-inch minimum depth noted in Section 3.11.4 and depicted in Figure 3.39).

**3.11.5 Wetland Construction Sequence**

The construction sequence for stormwater wetlands depends on site conditions, design complexity, and the size and configuration of the proposed facility. The following two-stage construction sequence is recommended for installing an on-line wetland facility and establishing vigorous plant cover.

**Stage 1 Construction Sequence: Wetland Facility Construction.**

**Step 1: Stabilize Drainage Area.** Stormwater wetlands should only be constructed after the contributing drainage area to the wetland is completely stabilized. If the proposed wetland site will be used as a sediment trap or basin during the construction phase, the construction notes must clearly indicate that the facility will be de-watered, dredged and re-graded to design dimensions after the original site construction is complete.

**Step 2: Assemble Construction Materials On-site.** Make sure they meet design specifications, and prepare any staging areas.

**Step 3: Clear and Strip Project Area** to the desired sub-grade.

**Step 4: Install Erosion and Sediment (E&S) Controls** prior to construction, including temporary dewatering devices, sediment basins, and stormwater diversion practices. All areas surrounding the wetland that are graded or denuded during construction of the wetland are to be planted with turf grass, native plant materials or other approved methods of soil stabilization. Grass sod is preferred over seed to reduce seed colonization of the wetland. During construction the wetland must be separated from the contributing drainage area so that no sediment flows into the wetland areas. In some cases, a phased or staged E&S Control plan may be necessary to divert flow around the stormwater wetland area until installation and stabilization are complete.

**Step 5: Excavate the Core Trench for the Embankment and Install the Spillway Pipe.**

**Step 6: Install the Riser or Outflow Structure** and ensure that the top invert of the overflow weir is constructed level and at the proper design elevation (flashboard risers are strongly recommended by Hunt et al, 2007).

**Step 7: Construct the Embankment and any Internal Berms** in 8 to 12-inch lifts and compacted with appropriate equipment.

**Step 8: Excavate/Grade** until the appropriate elevation and desired contours are achieved for the bottom and side slopes of the wetland. This is normally done by “roughing up” the interim elevations with a skid loader or other similar equipment to achieve the desired topography across the wetland. Spot surveys should be made to ensure that the interim elevations are 3 to 6 inches below the final elevations for the wetland.



**Step 9: Install Micro-Topographic Features and Soil Amendments** within wetland area. Since most stormwater wetlands are excavated to deep sub-soils, they often lack the nutrients and organic matter needed to support vigorous growth of wetland plants. It is therefore essential to add sand, compost, topsoil or wetland mulch to all depth zones in the wetland. The importance of soil amendments in excavated wetlands cannot be over-emphasized; poor survival and future wetland coverage are likely if soil amendments are not added. The planting soil should be a high organic content loam or sandy loam, placed by mechanical methods, and spread by hand. Planting soil depth should be at least 4 inches for shallow wetlands. No machinery should be allowed to traverse over the planting soil during or after construction. Planting soil should be tamped as directed in the design specifications, but it should not be overly compacted. After the planting soil is placed, it should be saturated and allowed to settle for at least one week prior to installation of plant materials.

**Step 10: Construct the Emergency Spillway** in cut or structurally stabilized soils.

**Step 11: Install Outlet Pipes**, including the downstream rip-rap apron protection.

**Step 12: Stabilize Exposed Soils** with temporary seed mixtures appropriate for a wetland environment. All wetland features above the normal pool elevation should be temporarily stabilized by hydro-seeding or seeding over straw.

### **Stage 2 Construction Sequence: Establishing the Wetland Vegetation.**

**Step 13: Finalize the Wetland Landscaping Plan.** At this stage the engineer, landscape architect, and wetland expert work jointly to refine the initial wetland landscaping plan after the stormwater wetland has been constructed. Several weeks of standing time is needed so that the designer can more precisely predict the following two things:

- Where the inundation zones are located in and around the wetland; and
- Whether the final grade and wetland microtopography will persist over time.

This allows the designer to select appropriate species and additional soil amendments, based on field confirmation of soils properties and the actual depths and inundation frequencies occurring within the wetland.

**Step 14: Open Up the Wetland Connection.** Once the final grades are attained, the pond and/or contributing drainage area connection should be opened to allow the wetland cell to fill up to the normal pool elevation. Gradually inundate the wetland erosion of unplanted features. Inundation must occur in stages so that deep pool and high marsh plant materials can be placed effectively and safely. Wetland planting areas should be at least partially inundated during planting to promote plant survivability.

**Step 15: Measure and Stake Planting Depths** at the onset of the planting season. Depths in the wetland should be measured to the nearest inch to confirm the original planting depths of the planting zone. At this time, it may be necessary to modify the plan to reflect altered depths or a change in the availability of wetland plant stock. Surveyed planting zones should be marked on the as-built or design plan, and their locations should also be identified in the field, using stakes or flags.

**Step 16:** Propagate the Stormwater Wetland. Three techniques are used in combination to propagate the emergent community over the wetland bed:

1. **Initial Planting of Container-Grown Wetland Plant Stock.** The transplanting window extends from early April to mid-June. Planting after these dates is quite chancy, since emergent wetland plants need a full growing season to build the root reserves needed to get through the winter. It is recommended that plants be ordered at least 6 months in advance to ensure the availability and on-time delivery of desired species.
2. **Broadcasting Wetland Seed Mixes.** The higher wetland elevations should be established by broadcasting wetland seed mixes to establish diverse emergent wetlands. Seeding of switchgrass or wetland seed mixes as a ground cover is recommended for all zones above 3 inches below the normal pool elevation. Hand broadcasting or hydroseeding can be used to spread seed, depending on the size of the wetland cell.
3. **Allowing “Volunteer Wetland Plants to Establish on Their Own.** The remaining areas of the stormwater wetland will eventually (within 3 to 5 years) be colonized by volunteer species from upstream or the forest buffer.

**Step 17:** Install Goose Protection to Protect Newly Planted or Newly Growing Vegetation. This is particularly critical for newly established emergents and herbaceous plants, as predation by Canada geese can quickly decimate wetland vegetation. Goose protection can consist of netting, webbing, or string installed in a criss-cross pattern over the surface area of the wetland, above the level of the emergent plants.

**Step 18:** Plant the Wetland Fringe and Buffer Area. This zone generally extends from 1 to 3 feet above the normal pool elevation (from the shoreline fringe to about half of the maximum water surface elevation for the 2-year storm). Consequently, plants in this zone are infrequently inundated (5 to 10 times per year), and must be able to tolerate both wet and dry periods.

**Construction Supervision.** Supervision during construction is recommended to ensure that stormwater wetlands are properly constructed and established. Multiple site visits and inspections by a qualified professional are recommended during the following stages of the wetland construction process:

- Preconstruction meeting
- Initial site preparation (including installation of project E&S controls)
- Excavation/Grading (e.g., interim/final elevations)
- Wetland installation (e.g., microtopography, soil amendments and staking of planting zones)
- Planting Phase (with an experienced landscape architect or wetland expert)
- Final Inspection (develop a punch list for facility acceptance)

DDOE’s construction phase inspection checklist for Constructed Wetlands can be found in Appendix L.

### 3.11.6 Wetland Landscaping Criteria

An initial wetland landscaping plan is required for any stormwater wetland and should be jointly developed by the engineer and a wetlands expert or experienced landscape architect. The plan should outline a detailed schedule for the care, maintenance and possible reinforcement of vegetation in the wetland and its buffer for up to 10 years after the original planting.

The plan should outline a realistic, long-term planting strategy to establish and maintain desired wetland vegetation. The plan should indicate how wetland plants will be established within each inundation zone (e.g., wetland plants, seed-mixes, volunteer colonization, and tree and shrub stock) and whether soil amendments are needed to get plants started. At a minimum, the plan should contain the following:

- Plan view(s) with topography at a contour interval of no more than 1 foot and spot elevations throughout the cell showing the wetland configuration, different planting zones (e.g., high marsh, deep water, upland), microtopography, grades, site preparation, and construction sequence.
- A plant schedule and planting plan specifying emergent, perennial, shrub and tree species, quantity of each species, stock size, type of root stock to be installed, and spacing. To the degree possible, the species list for the constructed wetland should contain plants found in similar local wetlands.

The following general guidance is provided:

- **Use Native Species Where Possible.** Table 3.47 provides a list of common native shrub and tree species and Table 3.48 provides a list of common native emergent, submergent and perimeter plant species, all of which have proven to do well in stormwater wetlands in the mid-Atlantic region and are generally available from most commercial nurseries (for a list of some of these nurseries, see Error! Reference source not found.). Other native species can be used that appear in state-wide plant lists. The use of native species is strongly encouraged, but in some cases, non-native ornamental species may be added as long as they are not invasive. Invasive species such as cattails, Phragmites and purple loosestrife must not be planted.
- **Match Plants to Inundation Zones.** The various plant species shown in Table 3.47 and Table 3.48 should be matched to the appropriate inundation zone. The first four inundation zones are particularly applicable to stormwater wetlands, as follows:

**Zone 1** -6 inches to -12 below the normal pool elevation

**Zone 2** -6 inches to the normal pool elevation)

**Zone 3** From the normal pool elevation to + 12 inches above it)

**Zone 4** +12 inches to + 36 inches above the normal pool elevation (i.e., above ED Zone)

Note: The Low Marsh Zone (-6 inches to -18 inches below the normal pool elevation) has been dropped since experience has shown that few emergent wetland plants flourish in this deeper zone.

- **Aggressive Colonizers.** To add diversity to the wetland, 5 to 7 species of emergent wetland plants should be planted, using at least four emergent species designated as aggressive colonizers (shown in bold in Table 3.48). No more than 25 percent of the high marsh wetland surface area needs to be planted. If the appropriate planting depths are achieved, the entire wetland should be colonized within three years. Individual plants should be planted 18 inches on center within each single species –eluster”.

**Table 3.47 Popular, Versatile, and Available Native Trees and Shrubs for Constructed Wetlands**

Shrubs		Trees	
Common and Scientific Names	Zone <sup>1</sup>	Common and Scientific Names	Zone <sup>1</sup>
Button Bush ( <i>Cephalanthus occidentalis</i> )	2, 3	Atlantic White Cedar ( <i>Chamaecyparis thyoides</i> )	2, 3
Common Winterberry ( <i>Ilex verticillata</i> )	3, 4	Bald Cypress ( <i>Taxodium distichum</i> )	2, 3
Elderberry ( <i>Sambucus canadensis</i> )	3	Black Willow ( <i>Salix nigra</i> )	3, 4
Indigo Bush ( <i>Amorpha fruticosa</i> )	3	Box Elder ( <i>Acer Negundo</i> )	2, 3
Inkberry ( <i>Ilex glabra</i> )	2, 3	Green Ash ( <i>Fraxinus pennsylvanica</i> )	3, 4
Smooth Alder ( <i>Alnus serrulata</i> )	2, 3	Grey Birch ( <i>Betula populifolia</i> )	3, 4
Spicebush ( <i>Lindera benzoin</i> )	3, 4	Red Maple ( <i>Acer rubrum</i> )	3, 4
Swamp Azalea ( <i>Azalea viscosum</i> )	2, 3	River Birch ( <i>Betula nigra</i> )	3, 4
Swamp Rose ( <i>Rosa palustris</i> )	2, 3	Swamp Tupelo ( <i>Nyssa biflora</i> )	2, 3
Sweet Pepperbush ( <i>Clethra ainifolia</i> )	2, 3	Sweetbay Magnolia ( <i>Magnolia virginiana</i> )	3, 4
		Sweetgum ( <i>Liquidambar styraciflua</i> )	3, 4
		Sycamore ( <i>Platanus occidentalis</i> )	3, 4
		Water Oak ( <i>Quercus nigra</i> )	3, 4
		Willow Oak ( <i>Quercus phellos</i> )	3,4

<sup>1</sup>Zone 1: -6 to -12 **OR** -18 inches below the normal pool elevation

Zone 2: -6 inches to the normal pool elevation

Zone 3: From the normal pool elevation to +12 inches

Zone 4: +12 to +36 inches; above ED zone

Source: Virginia DCR Stormwater Design Specification No. 13: Constructed Wetlands Version 1.8. 2010.

**Table 3.48 Popular, Versatile, and Available Native Emergent and Submergent Vegetation for Constructed Wetlands**

Plant	Zone <sup>1</sup>	Form	Inundation Tolerance	Wildlife Value	Notes
Arrow Arum ( <i>Peltandra virginica</i> )	2	Emergent	Up to 1 ft	High; berries are eaten by wood ducks	Full sun to partial shade
<b>Broad-Leaf Arrowhead (Duck Potato)</b> ( <i>Sagittaria latifolia</i> )	2	Emergent	Up to 1 ft	Moderate; tubers and seeds eaten by ducks	Aggressive colonizer
Blueflag Iris* ( <i>Iris versicolor</i> )	2, 3	Emergent	Up to 6 in.	Limited	Full sun (to flower) to partial shade
Broomsedge ( <i>Andropogon virginianus</i> )	2, 3	Perimeter	Up to 3 in.	High; songbirds and browsers; winter food and cover	Tolerant of fluctuating water levels and partial shade
<b>Bulltongue Arrowhead</b> ( <i>Sagittaria lancifolia</i> )	2, 3	Emergent	0–24 in.	Waterfowl, small mammals	Full sun to partial shade
<b>Burreed</b> ( <i>Sparganium americanum</i> )	2, 3	Emergent	0–6 in.	Waterfowl, small mammals	Full sun to partial shade
Cardinal Flower * ( <i>Lobelia cardinalis</i> )	3	Perimeter	Periodic inundation	Attracts hummingbirds	Full sun to partial shade
<b>Common Rush</b> ( <i>Juncus spp.</i> )	2, 3	Emergent	Up to 12 in.	Moderate; small mammals, waterfowl, songbirds	Full sun to partial shade
<b>Common Three Square</b> ( <i>Scirpus pungens</i> )	2	Emergent	Up to 6 in.	High; seeds, cover, waterfowl, songbirds	Fast colonizer; can tolerate periods of dryness; full sun; high metal removal
Duckweed ( <i>Lemna sp.</i> )	1, 2	Submergent / Emergent	Yes	High; food for waterfowl and fish	May biomagnify metals beyond concentrations found in the water
Joe Pye Weed ( <i>Eupatorium purpureum</i> )	2, 3	Emergent	Drier than other Joe-Pye Weeds; dry to moist areas; periodic inundation	Butterflies, songbirds, insects	Tolerates all light conditions
<b>Lizard's Tail</b> ( <i>Saururus cernuus</i> )	2	Emergent	Up to 1 ft	Low; except for wood ducks	Rapid growth; shade-tolerant
Marsh Hibiscus ( <i>Hibiscus moscheutos</i> )	2, 3	Emergent	Up to 3 in.	Low; nectar	Full sun; can tolerate periodic dryness
<b>Pickerelweed</b> ( <i>Pontederia cordata</i> )	2, 3	Emergent	Up to 1 ft	Moderate; ducks, nectar for butterflies	Full sun to partial shade
Pond Weed ( <i>Potamogeton pectinatus</i> )	1	Submergent	Yes	Extremely high; waterfowl, marsh and shore birds	Removes heavy metals from the water
Rice Cutgrass ( <i>Leersia oryzoides</i> )	2, 3	Emergent	Up to 3 in.	High; food and cover	Prefers full sun, although tolerant of shade; shoreline stabilization

Plant	Zone <sup>1</sup>	Form	Inundation Tolerance	Wildlife Value	Notes
<b>Sedges</b> ( <i>Carex spp.</i> )	2, 3	Emergent	Up to 3 in.	High; waterfowl, songbirds	Wetland and upland species
<b>Softstem Bulrush</b> ( <i>Scirpus validus</i> )	2, 3	Emergent	Up to 2 ft	Moderate; good cover and food	Full sun; aggressive colonizer; high pollutant removal
<b>Smartweed</b> ( <i>Polygonum spp.</i> )	2	Emergent	Up to 1 ft	High; waterfowl, songbirds; seeds and cover	Fast colonizer; avoid weedy aliens, such as <i>P. Perfoliatum</i>
<b>Spatterdock</b> ( <i>Nuphar luteum</i> )	2	Emergent	Up to 1.5 ft	Moderate for food, but High for cover	Fast colonizer; tolerant of varying water levels
Switchgrass ( <i>Panicum virgatum</i> )	2, 3, 4	Perimeter	Up to 3 in.	High; seeds, cover; waterfowl, songbirds	Tolerates wet/dry conditions
Sweet Flag * ( <i>Acorus calamus</i> )	2, 3	Perimeter	Up to 3 in.	Low; tolerant of dry periods	Tolerates acidic conditions; not a rapid colonizer
Waterweed ( <i>Elodea canadensis</i> )	1	Submergent	Yes	Low	Good water oxygenator; high nutrient, copper, manganese and chromium removal
Wild celery ( <i>Valisneria americana</i> )	1	Submergent	Yes	High; food for waterfowl; habitat for fish and invertebrates	Tolerant of murkey water and high nutrient loads
Wild Rice ( <i>Zizania aquatica</i> )	2	Emergent	Up to 1 ft	High; food, birds	Prefers full sun
<b>Woolgrass</b> ( <i>Scirpus cyperinus</i> )	3, 4	Emergent	yes	High: waterfowl, small mammals	Fresh tidal and nontidal, swamps, forested wetlands, meadows, ditches

<sup>1</sup>Zone 1: -6 to -12 **OR** -18 inches below the normal pool elevation

Zone 2: -6 inches to the normal pool elevation

Zone 3: From the normal pool elevation to +12 inches

Zone 4: +12 to +36 inches; above ED zone

\* Not a major colonizer, but adds color (Aggressive colonizers are shown in **bold** type)

Source: Virginia DCR Stormwater Design Specification No. 13: Constructed Wetlands Version 1.8. 2010.

- **Suitable Tree Species.** The major shift in stormwater wetland design is to integrate trees and shrubs into the design, in tree islands, peninsulas, and fringe buffer areas. Deeper-rooted trees and shrubs that can extend to the stormwater wetland's local water table are important for creating a mixed wetland community. Table 3.47 above presents some recommended tree and shrub species in the mid-Atlantic region for different inundation zones. A good planting strategy includes varying the size and age of the plant stock to promote a diverse structure. Using locally grown container or bare root stock is usually the most successful approach, if planting in the spring. It is recommended that buffer planting areas be over-planted with a small stock of fast growing successional species to achieve quick canopy closure and shade out invasive plant species. Trees may be planted in clusters to share rooting space on

compacted wetland side-slopes. Planting holes should be amended with compost (a 2:1 ratio of loose soil to compost) prior to planting.

- **Pre- and Post-Nursery Care.** Plants should be kept in containers of water or moist coverings to protect their root systems and keep them moist when in transporting them to the planting location. As much as six to nine months of lead time may be needed to fill orders for wetland plant stock from aquatic plant nurseries (. Consult DDOE's webpage for information on area suppliers.

### 3.11.7 Wetland Maintenance Criteria

Successful establishment of constructed wetland areas requires that the following tasks be undertaken in the first two years:

- **Initial Inspections.** During the first 6 months following construction, the site should be inspected by a qualified professional at least twice after storm events that exceed 1/2 inch of rainfall.
- **Spot Reseeding.** Inspections should include looking for bare or eroding areas in the contributing drainage area or around the wetland buffer, and make sure they are immediately stabilized with grass cover.
- **Watering.** Trees planted in the buffer and on wetland islands and peninsulas need watering during the first growing season. In general, consider watering every three days for first month, and then weekly during the first growing season (April - October), depending on rainfall.
- **Reinforcement Plantings.** Regardless of the care taken during the initial planting of the wetland and buffer, it is probable that some areas will remain unvegetated and some species will not survive. Poor survival can result from many unforeseen factors, such as predation, poor quality plant stock, water level changes, drought. Thus, it is advisable to budget for an additional round of reinforcement planting after one or two growing seasons. Construction contracts should include a care and replacement warranty extending at least two growing seasons after initial planting, to selectively replant portions of the wetland that fail to fill in or survive. If a minimum coverage of 50 percent is not achieved in the planted wetland zones after the second growing season, a reinforcement planting will be required.

Managing vegetation is an important ongoing maintenance task at every constructed wetland and for each inundation zone. Following the design criteria above should result in a reduced need for regular mowing of the embankment and access roads. Vegetation within the wetland, however, will require some annual maintenance.

Designers should expect significant changes in wetland species composition to occur over time. Inspections should carefully track changes in wetland plant species distribution over time. Invasive plants should be dealt with as soon as they begin to colonize the wetland. As a general rule, control of undesirable invasive species (e.g., cattails and Phragmites) should commence when their coverage exceeds more than 15 percent of a wetland cell area. Although the application of herbicides is not recommended, some types (e.g., Glyphosate) have been used to control cattails with some success. Extended periods of dewatering may also work, since early manual removal provides only short-term relief from invasive species. While it is difficult to

exclude invasive species completely from stormwater wetlands, their ability to take over the entire wetland can be reduced if the designer creates a wide range of depth zones and a complex internal structure within the wetland.

Thinning or harvesting of excess forest growth may be periodically needed to guide the forested wetland into a more mature state. Vegetation may need to be harvested periodically if the constructed wetland becomes overgrown. Thinning or harvesting operations should be scheduled to occur approximately 5 and 10 years after the initial wetland construction. Removal of woody species on or near the embankment and maintenance access areas should be conducted every 2 years.

Designers should refer to Section 3.10.7 Pond Maintenance Criteria for additional maintenance responsibilities associated with wetlands. Ideally, maintenance of constructed wetlands should be driven by annual inspections by a qualified professional that evaluate the condition and performance of the wetland. Based on inspection results, specific maintenance tasks will be triggered. DDOE’s maintenance inspection checklist for stormwater wetlands can be found in Appendix M.

**Declaration of Covenants.** A declaration of covenants that includes all maintenance responsibilities to ensure the continued stormwater performance for the BMP is required. The declaration of covenants specifies the property owner’s primary maintenance responsibilities, and authorizes DDOE staff to access the property for inspection or corrective action in the event the proper maintenance is not performed. The declaration of covenants is attached to the deed of the property. An example form is provided at the end of Chapter 5 though variations will exist for scenarios where stormwater crosses property lines. The covenant is between the property and the District Government. It is submitted through the Office of the Attorney General (OAG). All SWMPs have a maintenance agreement stamp that must be signed for a building permit to proceed. A maintenance schedule must appear on the SWMP. Additionally, a maintenance schedule is required in schedule c of the declaration of covenants.

Covenants are not required on government properties, but maintenance responsibilities must be defined through a partnership agreement or a memorandum of understanding.

**Waste Material.** Waste material from the repair, maintenance, or removal of a BMP or land cover shall be removed and disposed of in compliance with applicable federal and District law.

### 3.11.8 Wetland Stormwater Compliance Calculations

Stormwater wetlands receive 10 percent retention value and are an accepted TSS removal practice for the amount of storage volume (Sv) provided by the BMP (Table 3.49).

**Table 3.49 Wetland Retention Value and Pollutant Removal**

Retention Value	= $0.1 \times Sv$
Accepted TSS Treatment Practice	Yes



### 3.11.9 References

Cappiella, K., T. Schueler and T. Wright. 2006. Urban Watershed Forestry Manual: Part 2: Conserving and Planting Trees at Development Sites. USDA Forest Service. Center for Watershed Protection. Ellicott City, MD.

Hunt, W., M. Burchell, J. Wright and K. Bass. 2007. "Stormwater Wetland Design Update: Zones, Vegetation, Soil and Outlet Guidance." Urban Waterways. North Carolina State Cooperative Extension Service. Raleigh, NC.

Minnesota Stormwater Steering Committee (MSSC). 2005. Minnesota Stormwater Manual. Emmons & Oliver Resources, Inc. Minnesota Pollution Control Agency. St. Paul, MN.

Virginia DCR Stormwater Design Specification No. 13: Constructed Wetlands Version 1.8. 2010.

### 3.12 Storage Practices

**Definition.** Storage practices are explicitly designed to provide stormwater detention (2-year, 15-year, and/or flood control). Design variants include:

- S-1 Underground detention vaults and tanks
- S-2 Dry detention pond
- S-3 Rooftop storage
- S-4 Stone storage under permeable pavement or other BMPs

Detention vaults are box-shaped underground stormwater storage facilities typically constructed with reinforced concrete. Detention tanks are underground storage facilities typically constructed with large diameter metal or plastic pipe. Both serve as an alternative to surface dry detention for stormwater quantity control, particularly for space-limited areas where there is not adequate land for a dry detention basin or multi-purpose detention area. Prefabricated concrete vaults are available from commercial vendors. In addition, several pipe manufacturers have developed packaged detention systems.

Dry detention ponds are widely applicable for most land uses and are best suited for larger drainage areas an outlet structure restricts stormwater flow so it backs up and is stored within the basin. The temporary ponding reduces the maximum peak discharge to the downstream channel, thereby reducing the effective shear stress on the bed and banks of the receiving stream.

Storage practices do not receive any stormwater retention or treatment volume and should be considered only for management of larger storm events. Storage practices are not considered an acceptable practice to meet the SWRv. Storage practices must be combined with a separate facility to meet these requirements. Upland practices can be used to satisfy some or all of the stormwater retention requirements at many sites, which can help to reduce the footprint and volume of storage practices.

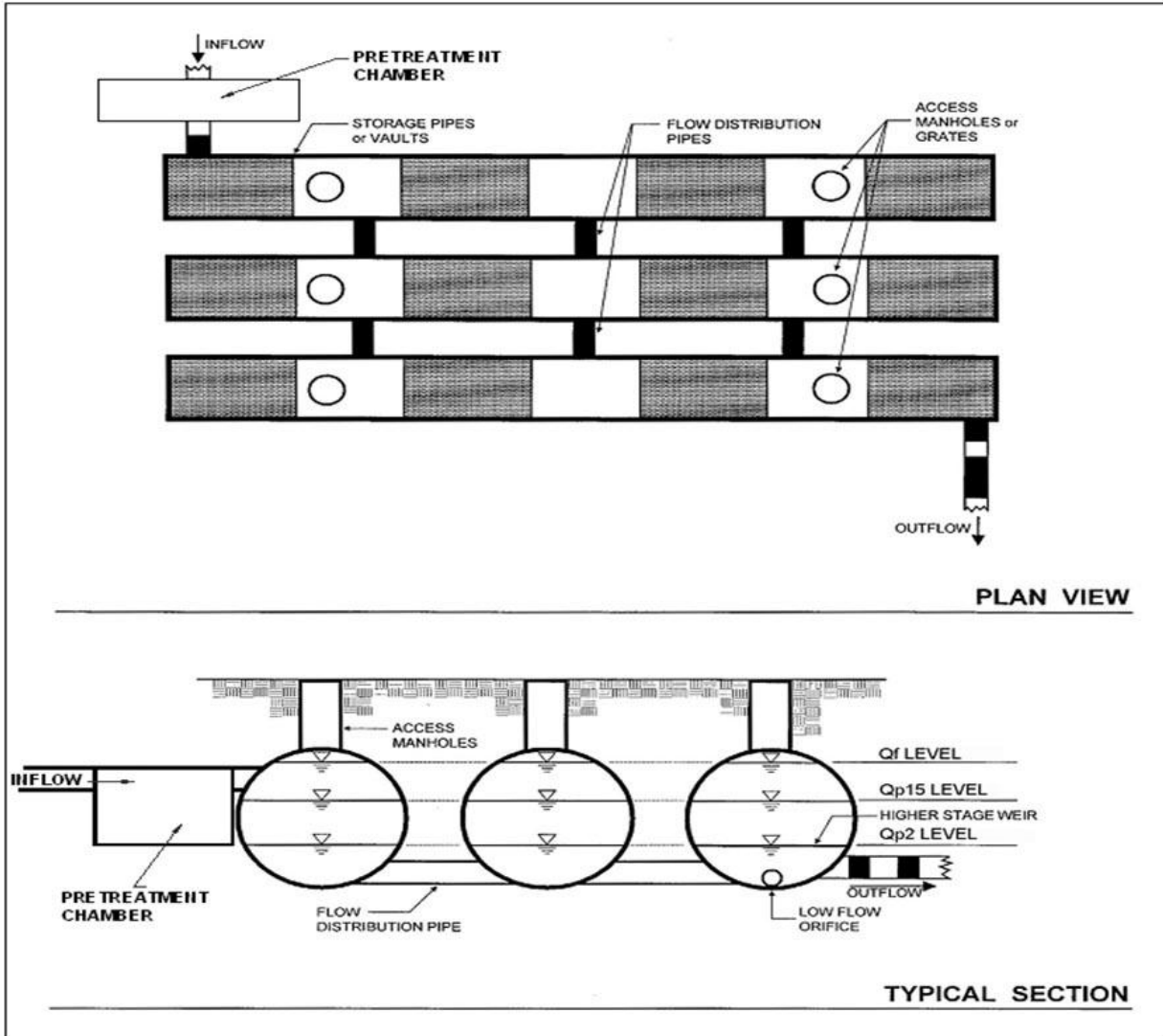


Figure 3.40 Example of an underground detention vault and/or tank (S-1).

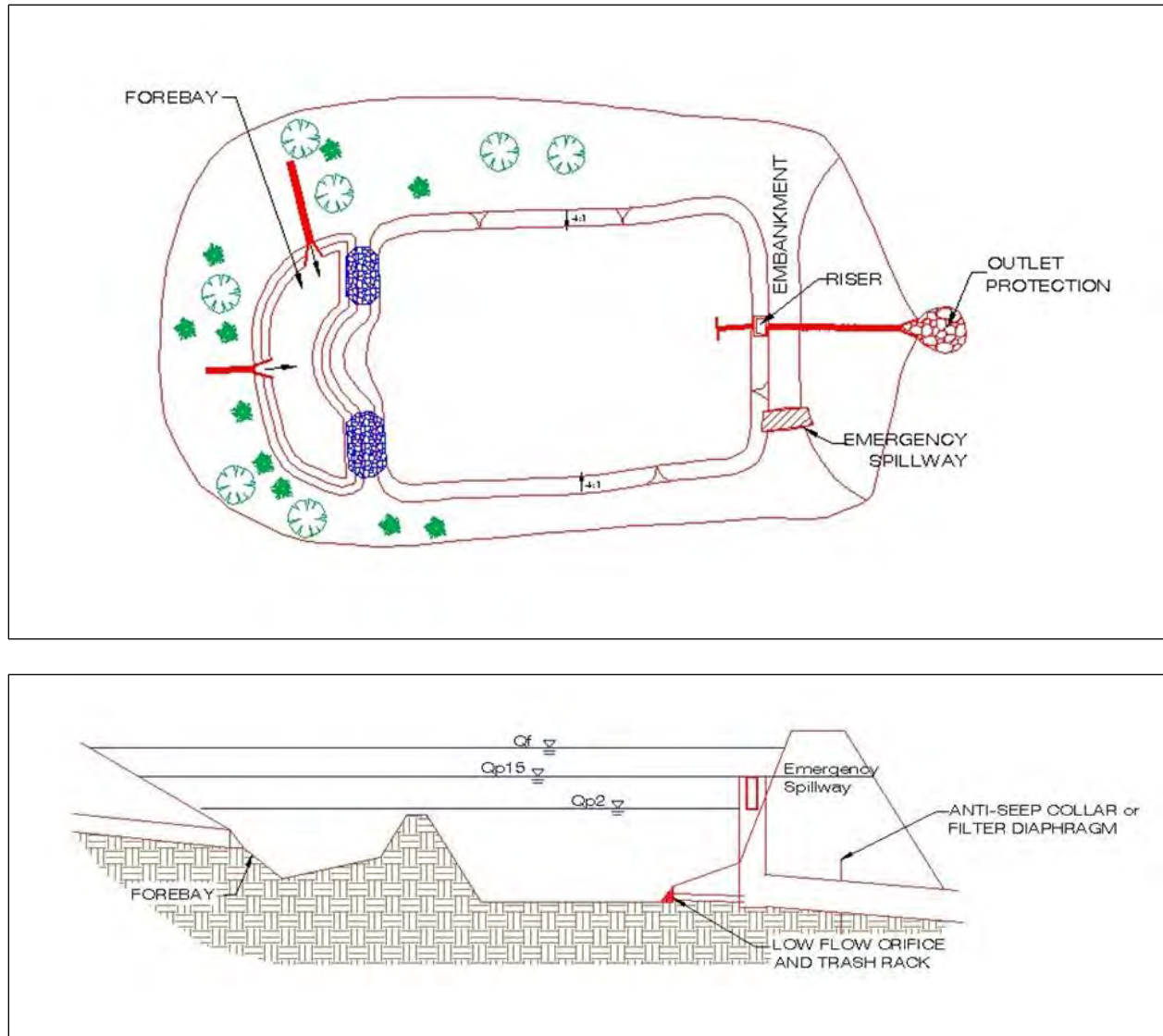


Figure 3.41 Example of a dry detention pond (S-2).

### 3.12.1 Storage Feasibility Criteria

The following feasibility issues need to be evaluated when storage practices are considered as the final practice in a treatment train:

**Space Required.** A typical storage practices requires a footprint of 1 to 3 percent of its contributing drainage area, depending on the depth of the pond or storage vault (i.e., the deeper the practice, the smaller footprint needed).

**Contributing Drainage Area.** A contributing drainage area of at least 10 acres is preferred for dry ponds in order to keep the required orifice size from becoming a maintenance problem. Designers should be aware that small “pocket” ponds will typically (1) have very small orifices that will be prone to clogging, (2) experience fluctuating water levels such that proper

stabilization with vegetation is very difficult, and (3) generate more significant maintenance problems.

Underground detention systems can be located downstream of other structural stormwater controls providing treatment of the design storm. For treatment train designs where upland practices are utilized for treatment of the SWR<sub>v</sub>, designers can use a site-adjusted R<sub>v</sub> or CN that reflects the volume reduction of upland practices and likely reduce the size and cost of detention (see Storage Practice Sizing in Section 3.12.4 Storage Design Criteria).

The maximum contributing drainage area to be served by a single underground detention vault or tank is 25 acres.

**Available Hydraulic Head.** The depth of a storage practice is usually determined by the amount of hydraulic head available at the site (dimension between the surface drainage and the bottom elevation of the site). The bottom elevation is normally the invert of the existing downstream conveyance system to which the storage practice discharges. Depending on the size of the development and the available surface area of the basin, as much as 6 to 8 feet of hydraulic head may be needed for a dry detention practice to function properly for storage. An underground storage practice will require sufficient head room to facilitate maintenance—at least 5 feet depending on the design configuration.

**Setbacks.** To avoid the risk of seepage, storage practices must not be hydraulically connected to structure foundations. Setbacks to structures must be at least 10 feet and adequate water-proofing protection must be provided for foundations and basements.

**Depth to Water Table and Bedrock.** Dry ponds are not allowed if the water table or bedrock will be within 2 feet of the floor of the pond. For underground detention facilities, an anti-flotation analysis is required to check for buoyancy problems in the high water table areas.

**Soils.** The permeability of soils is seldom a design constraint for storage practices. Soil infiltration tests should be conducted at proposed dry pond sites to estimate infiltration rates and patterns, which can be significant in Hydrologic Soil Group (HSG) A soils and some group B soils. Infiltration through the bottom of the pond is typically encouraged unless it may potentially migrate laterally through a soil layer and impair the integrity of the embankment or other structure.

**Structural Stability.** Underground detention vaults and tanks must meet structural requirements for overburden support and traffic loading if appropriate as verified by shop drawings signed by an appropriately licensed professional.

**Geotechnical Tests.** At least one soil boring must be taken at a low point within the footprint of any proposed storage practice to establish the water table and bedrock elevations and evaluate soil suitability. A geotechnical investigation is required for all underground BMPs, including underground storage systems. Geotechnical testing requirements are outlined in Appendix P.

**Utilities.** For a dry pond system, no utility lines shall be permitted to cross any part of the embankment where the design water depth is greater than 2 feet. Typically, utilities require a minimum 5-foot horizontal clearance from storage facilities.

**Perennial Streams.** Locating dry ponds on perennial streams will require both a Section 401 and Section 404 permit from the appropriate state or federal regulatory agency.

### 3.12.2 Storage Conveyance Criteria

Designers must use accepted hydrologic and hydraulic routing calculations to determine the required storage volume and an appropriate outlet design for storage practices. See Section 2.7 Hydrology Methods for a summary of acceptable hydrological methodologies and models.

For management of the 2-year storm, a control structure with a trash rack designed to release the required pre-development  $Q_{p2}$  must be provided. Ideally, the channel protection orifice should have a minimum diameter of 3 inches in order to pass minor trash and debris. However, where smaller orifices are required, the orifice must be adequately protected from clogging by an acceptable external trash rack.

As an alternative, the orifice diameter may be reduced if internal orifice protection is used (i.e., a perforated vertical stand pipe with 0.5-inch orifices or slots that are protected by wirecloth and a stone filtering jacket). Adjustable gate valves, weir manholes, and other structures designed for simple maintenance can also be used to achieve this equivalent diameter.

For overbank flood protection, an additional outlet is sized for  $Q_{p15}$  control and can consist of a weir, orifice, outlet pipe, combination outlet, or other acceptable control structure.

Riprap, plunge pools or pads, or other energy dissipaters are to be placed at the end of the outlet to prevent scouring and erosion and to provide a non-erosive velocity of flow from the structure to a water course. The design must specify an outfall that will be stable for the 15-year design storm event. The channel immediately below the storage practice outfall must be modified to prevent erosion. This is typically done by calculating channel velocities and flow depths, then placing appropriately sized riprap, over geotextile fabric, which can reduce flow velocities from the principal spillway to non-erosive levels (3.5 to 5.0 fps depending on the channel lining material). The storage practice geometry and outfall design may need to be altered in order to yield adequate channel velocities and flow.

Flared pipe sections that discharge at or near the stream invert or into a step pool arrangement should be used at the spillway outlet. An outfall analysis shall be included in the stormwater management plan showing discharge velocities down to the nearest downstream water course. Where indicated, the developer / contractor must secure an off-site drainage easement for any improvements to the downstream channel.

When the discharge is to a manmade pipe or channel system, the system must be adequate to convey the required design storm peak discharge.

If discharge daylight to a channel with dry weather flow, care should be taken to minimize tree clearing along the downstream channel, and to reestablish a forested riparian zone in the shortest possible distance. Excessive use of rip-rap should be avoided.

The final release rate of the facility shall be modified if any increase in flooding or stream channel erosion would result at a downstream structure, highway, or natural point of restricted streamflow (see Section 2.6 Additional Stormwater Management Requirements).

The following **additional** conveyance criteria apply to underground detention:

- An internal or external high flow bypass or overflow must be included in the underground detention designs to safely pass the extreme flood flow.

The following **additional** conveyance criteria apply to dry ponds:

- **Primary Spillway.** The primary spillway shall be designed with acceptable anti-flotation, anti-vortex, and trash rack devices. The spillway must generally be accessible from dry land. When reinforced concrete pipe is used for the principal spillway to increase its longevity, –Ø”-ring gaskets (ASTM C-361) must be used to create watertight joints, and they should be inspected during installation.
- The risk of clogging in outlet pipes with small orifices can be reduced by:
  - ◆ Providing a micropool at the outlet structure. For more information on micropool extended detention ponds see Section 3.10 Stormwater Ponds.
  - ◆ Installing a trash rack to screen the low-flow orifice.
  - ◆ Using a perforated pipe under a gravel blanket with an orifice control at the end in the riser structure.
- **Emergency Spillway.** Dry ponds must be constructed with overflow capacity to safely pass the 100-year design storm event through either the primary spillway or a vegetated or armored emergency spillway unless waived by DDOE.
- **Inlet Protection.** Inflow points into dry pond systems must be stabilized to ensure that non-erosive conditions exist during storm events up to the overbank flood event (i.e., the 15-year storm event).

### 3.12.3 Storage Pretreatment Criteria

**Dry Pond Pretreatment Forebay.** A forebay must be located at each major inlet to a dry pond to trap sediment and preserve the capacity of the main treatment cell. The following criteria apply to dry pond forebay design:

- A major inlet is defined as an individual storm drain inlet pipe or open channel serving at least 10 percent of the storage practice’s contributing drainage area.
- The forebay consists of a separate cell, formed by an acceptable barrier (e.g., an earthen berm, concrete weir, gabion baskets, etc.).
- The forebay shall be sized to contain 0.1 inches per impervious acre of contributing drainage. The relative size of individual forebays should be proportional to the percentage of the total inflow to the dry pond.

- The forebay should be designed in such a manner that it acts as a level spreader to distribute runoff evenly across the entire bottom surface area of the main storage cell.
- Exit velocities from the forebay shall be non-erosive or an armored overflow shall be provided. Non-erosive velocities are 4 feet per second for the two-year event, and 6 feet per second for the 15-year event.
- The bottom of the forebay may be hardened (e.g., concrete, asphalt, or grouted riprap) in order to make sediment removal easier.
- Direct maintenance access for appropriate equipment shall be provided to the each forebay.

**Underground Detention Pretreatment.** A pretreatment structure to capture sediment, coarse trash and debris must be placed upstream of any inflow points to underground detention. A separate sediment sump or vault chamber sized to capture 0.1 inches per impervious acre of contributing drainage, or a proprietary structure with demonstrated capability of removing sediment and trash, should be provided at the inlet for underground detention systems that are in a treatment train with off-line water quality treatment structural controls. Refer to Section 3.13 for information on approved proprietary practices.

#### 3.12.4 Storage Design Criteria

**Dry Pond Internal Design Features.** The following apply to dry pond design:

- **No Pilot Channels.** Dry ponds shall not have a low-flow pilot channel, but instead must be constructed in a manner whereby flows are evenly distributed across the pond bottom, to avoid scour, promote attenuation and, where possible, infiltration
- **Internal Slope.** The maximum longitudinal slope through the pond should be approximately 0.5 to 1 percent.
- **Side Slopes.** Side slopes within the dry pond should generally have a gradient of 3H:1V to 4H:1V. The mild slopes promote better establishment and growth of vegetation and provide for easier maintenance and a more natural appearance. Ponds with side slopes steeper than 5H:1V must be fenced and include a lockable gate.
- **Long Flow Path.** Dry pond designs should have an irregular shape and a long flow path distance from inlet to outlet to increase water residence time, treatment pathways, pond performance, and to eliminate short-cutting. In terms of flow path geometry, there are two design considerations: (1) the overall flow path through the pond, and (2) the length of the shortest flow path (Hirschman et al., 2009):
  - ◆ The overall flow path can be represented as the length-to-width ratio OR the flow path ratio. These ratios must be at least 2L:1W (3L:1W preferred). Internal berms, baffles, or topography can be used to extend flow paths and/or create multiple pond cells.
  - ◆ The shortest flow path represents the distance from the closest inlet to the outlet. The ratio of the shortest flow to the overall length must be at least 0.4. In some cases – due to site geometry, storm sewer infrastructure, or other factors—some inlets may not be able to meet these ratios. However, the drainage area served by these “closer” inlets must constitute no more than 20 percent of the total contributing drainage area.



**Safety Features.** The following safety features must be considered for storage practices:

- The principal spillway opening must be designed and constructed to prevent access by small children.
- End walls above pipe outfalls greater than 48 inches in diameter must be fenced at the top of the wall to prevent a falling hazard.
- Storage practices must incorporate an additional 1 foot of freeboard above the emergency spillway, or 2 feet of freeboard if design has no emergency spillway, for the maximum Q<sub>f</sub> design storm unless more stringent Dam Safety requirements apply.
- The emergency spillway must be located so that downstream structures will not be impacted by spillway discharges
- Underground maintenance access should be locked at all times.

**Maintenance Access.** All storage practices shall be designed so as to be accessible to annual maintenance. Unless waived by the DDOE, a 5:1 slope and 15 foot wide entrance ramp is required for maintenance access to dry ponds. Adequate maintenance access must also be provided for all underground detention systems. Access must be provided over the inlet pipe and outflow structure with access steps. Access openings can consist of a standard 30-inch diameter frame, grate and solid cover, or a hinged door or removable panel.

**Outlets.** Trash racks shall be provided for low-flow pipes and for risers not having anti-vortex devices.

In order to reduce maintenance problems for small orifices, a standpipe design can be used that includes a smaller inner standpipe with the required orifice size, surrounded by a larger standpipe with multiple openings, and a gravel jacket surrounding the larger standpipe. This design will reduce the likelihood of the orifice being clogged by sediment.

**Detention Vault and Tank Materials.** Underground stormwater detention structures shall be composed of materials as approved by the DDOE. All construction joints and pipe joints shall be water tight. Cast-in-place wall sections must be designed as retaining walls. The maximum depth from finished grade to the vault invert is 20 feet. The minimum pipe diameter for underground detention tanks is 24 inches unless otherwise approved by DDOE. Manufacturer's specifications should be consulted for underground detention structures.

**Anti-floatation Analysis for Underground Detention.** Anti-floatation analysis is required to check for buoyancy problems in the high water table areas. Anchors shall be designed to counter the pipe and structure buoyancy by at least a 1.2 factor of safety.

**Storage Practice Sizing.** Storage facilities should be sized to control peak flow rates from the 2-year and 15-year frequency storm event or other design storm. Design calculations must ensure that the post-development peak discharge does not exceed the pre-development peak discharge. See Section 2.7 Hydrology Methods for a summary of acceptable hydrological methodologies and models.

For treatment train designs where upland practices are utilized for treatment of the SWRV, designers can use a site-adjusted Rv or CN that reflects the volume reduction of upland practices to compute the Qp2 and Qp15 that must be treated by the storage practice.

### 3.12.5 Storage Landscaping Criteria

No landscaping criteria apply to underground storage practices.

For dry ponds, a landscaping plan must be provided that indicates the methods used to establish and maintain vegetative coverage within the dry pond. Minimum elements of a plan include the following:

- Delineation of pondscaping zones within the pond
- Selection of corresponding plant species
- The planting plan
- The sequence for preparing the wetland bed, if one is incorporated with the Dry pond (including soil amendments, if needed)
- Sources of native plant material
- The planting plan should allow the pond to mature into a native forest in the right places, but yet keep mowable turf along the embankment and all access areas. The wooded wetland concept proposed by Cappiella et al., (2005) may be a good option for many dry ponds.
- Woody vegetation may not be planted or allowed to grow within 15 feet of the toe of the embankment nor within 25 feet from the principal spillway structure.
- Avoid species that require full shade, or are prone to wind damage.

### 3.12.6 Storage Construction Sequence

Construction of underground storage systems must be in accordance with manufacturer's specifications. All runoff into the system should be blocked until the site is stabilized. The system must be inspected and cleaned of sediment after the site is stabilized.

The following is a typical construction sequence to properly install a dry pond. The steps may be modified to reflect different dry pond designs, site conditions, and the size, complexity and configuration of the proposed facility.

**Step 1: Use of Dry Pond for Erosion and Sediment Control.** A dry pond may serve as a sediment basin during project construction. If this is done, the volume should be based on the more stringent sizing rule (erosion and sediment control requirement vs. water quality treatment requirement). Installation of the permanent riser should be initiated during the construction phase, and design elevations should be set with final cleanout of the sediment basin and conversion to the post-construction dry pond in mind. The bottom elevation of the dry pond should be lower than the bottom elevation of the temporary sediment basin. Appropriate procedures must be implemented to prevent discharge of turbid waters when the basin is being converted into a dry pond.

**Step 2: Stabilize the Drainage Area.** Dry ponds should only be constructed after the contributing drainage area to the pond is completely stabilized. If the proposed dry pond site will be used as a sediment trap or basin during the construction phase, the construction notes must clearly indicate that the facility will be dewatered, dredged and re-graded to design dimensions after the original site construction is complete.

**Step 3: Assemble Construction Materials On-site,** make sure they meet design specifications, and prepare any staging areas.

**Step 4: Clear and Strip** the project area to the desired sub-grade.

**Step 5: Install Erosion and Sediment Controls** prior to construction, including temporary de-watering devices and stormwater diversion practices. All areas surrounding the pond that are graded or denuded during construction must be planted with turf grass, native plantings, or other approved methods of soil stabilization.

**Step 6: Install the Spillway Pipe.**

**Step 7: Install the Riser or Outflow Structure** and ensure the top invert of the overflow weir is constructed level at the design elevation.

**Step 8: Construct the Embankment and any Internal Berms** in 8 to 12-inch lifts and compact the lifts with appropriate equipment.

**Step 9: Excavate/Grade** until the appropriate elevation and desired contours are achieved for the bottom and side slopes of the dry pond.

**Step 10: Construct the Emergency Spillway** in cut or structurally stabilized soils.

**Step 11: Install Outlet Pipes,** including downstream rip-rap apron protection.

**Step 12: Stabilize Exposed Soils.** All areas above the normal pool elevation should be permanently stabilized by hydroseeding or seeding over straw.

**Dry Pond Construction Supervision.** Ongoing construction supervision is recommended to ensure that stormwater ponds are properly constructed. Supervision/inspection is recommended during the following stages of construction:

- Preconstruction meeting
- Initial site preparation (including installation of E&S controls)
- Excavation/Grading (interim and final elevations)
- Installation of the embankment, the riser/primary spillway, and the outlet structure
- Implementation of the pondscaping plan and vegetative stabilization
- Final inspection (develop a punch list for facility acceptance)

DDOE's construction phase inspection checklist for Storage Practices is available in Appendix L.

If the dry pond has a permanent pool, then to facilitate maintenance the contractor should measure the actual constructed dry pond depth at three areas within the permanent pool (forebay,

mid-pond and at the riser), and they should mark and geo-reference them on an as-built drawing. This simple data set will enable maintenance inspectors to determine pond sediment deposition rates in order to schedule sediment cleanouts.

### 3.12.7 Storage Maintenance Criteria

Typical maintenance activities for storage practices are outlined in Table 3.50. Maintenance requirements for underground storage facilities will generally require quarterly visual inspections from the manhole access points by a qualified professional to verify that there is no standing water or excessive sediment buildup. Entry into the system for a full inspection of the system components (pipe or vault joints, general structural soundness, etc.) should be conducted annually. Confined space entry credentials are typically required for this inspection.

**Table 3.50 Typical Maintenance Activities for Storage Practices**

Schedule	Maintenance Activity
As needed	<ul style="list-style-type: none"> <li>▪ Water dry pond side slopes to promote vegetation growth and survival</li> </ul>
Quarterly	<ul style="list-style-type: none"> <li>▪ Remove sediment and oil/grease from inlets, pre-treatment devices, flow diversion structures, storage practices and overflow structures.</li> <li>▪ Ensure that the contributing drainage area, inlets, and facility surface are clear of debris.</li> <li>▪ Ensure that the contributing drainage area is stabilized. Perform spot-reseeding where needed.</li> <li>▪ Repair undercut and eroded areas at inflow and outflow structures.</li> </ul>
Annual inspection	<ul style="list-style-type: none"> <li>▪ Measure sediment accumulation levels in forebay. Remove sediment when 50% of the forebay capacity has been lost.</li> <li>▪ Inspect the condition of stormwater inlets for material damage, erosion or undercutting. Repair as necessary.</li> <li>▪ Inspect the banks of upstream and downstream channels for evidence of sloughing, animal burrows, boggy areas, woody growth, or gully erosion that may undermine pond embankment integrity.</li> <li>▪ Inspect outfall channels for erosion, undercutting, rip-rap displacement, woody growth, etc.</li> <li>▪ Inspect condition of principal spillway and riser for evidence of spalling, joint failure, leakage, corrosion, etc.</li> <li>▪ Inspect condition of all trash racks, reverse sloped pipes or flashboard risers for evidence of clogging, leakage, debris accumulation, etc.</li> <li>▪ Inspect maintenance access to ensure it is free of debris or woody vegetation, and check to see whether valves, manholes and locks can be opened and operated.</li> <li>▪ Inspect internal and external side slopes of dry ponds for evidence of sparse vegetative cover, erosion, or slumping, and make needed repairs immediately.</li> <li>▪ Monitor the growth of wetlands, trees and shrubs planted in dry ponds. Remove invasive species and replant vegetation where necessary to ensure dense coverage.</li> </ul>

Maintenance of storage practices is driven by annual inspections that evaluate the condition and performance of the storage practice. Based on inspection results, specific maintenance tasks will be triggered.

DDOE's maintenance inspection checklists for Extended Detention Ponds can be found in Appendix M.

**Declaration of Covenants.** A declaration of covenants that includes all maintenance responsibilities to ensure the continued stormwater performance for the BMP is required. The declaration of covenants specifies the property owner’s primary maintenance responsibilities, and authorizes DDOE staff to access the property for inspection or corrective action in the event the proper maintenance is not performed. The declaration of covenants is attached to the deed of the property. An example form is provided at the end of Chapter 5 though variations will exist for scenarios where stormwater crosses property lines. The covenant is between the property and the District Government. It is submitted through the Office of the Attorney General (OAG). All SWMPs have a maintenance agreement stamp that must be signed for a building permit to proceed. A maintenance schedule must appear on the SWMP. Additionally, a maintenance schedule is required in schedule c of the declaration of covenants.

Covenants are not required on government properties, but maintenance responsibilities must be defined through a partnership agreement or a memorandum of understanding.

**Waste Material.** Waste material from the repair, maintenance, or removal of a BMP or land cover shall be removed and disposed of in compliance with applicable federal and District law.

### 3.12.8 Storage Volume Compliance Calculations

Storage practices receive no retention value and no pollutant removal for the storage volume (Sv) provided by the practice (Table 3.51). These practices should be used only for control of larger storm events.

**Table 3.51 Storage Retention Value and Pollutant Removal**

Retention Value	= 0
Accepted TSS Treatment Practice	No

### 3.12.9 References

Cappiella, K., Schueler, T., and T. Wright. 2005. Urban Watershed Forestry Manual. Part 1: Methods for Increasing Forest Cover in a Watershed. NA-TP-04-05. USDA Forest Service, Northeastern Area State and Private Forestry. Newtown Square, PA.

Hirschman, D., L. Woodworth and S. Drescher. 2009. Technical Report: Stormwater BMPs in Virginia’s James River Basin: An Assessment of Field Conditions & Programs. Center for Watershed Protection. Ellicott City, MD.

Virginia DCR Stormwater Design Specification No. 15: Extended Detention (ED) Pond Version 1.8. 2010.

### **3.13 Proprietary Practices**

**Definition.** Proprietary practices are manufactured stormwater treatment practices that utilize settling, filtration, absorptive/adsorptive materials, vortex separation, vegetative components, and/or other appropriate technology to manage the impacts stormwater runoff

Proprietary practices may be used to achieve treatment compliance, provided they have been approved by the District and meet the performance criteria outlined in this specification. Historically, proprietary practices do not provide retention volume. Proprietary practices will not be valued for retention volume unless the practice can demonstrate the occurrence of retention processes.

#### **3.13.1 Proprietary Practice Feasibility Criteria**

Individual proprietary practices will have different site constraints and limitations. Manufacturer's specifications should be consulted to ensure that proprietary practices are feasible for application on a site-by-site basis.

#### **3.13.2 Proprietary Practice Conveyance Criteria**

All proprietary practices must be designed to safely overflow or bypass flows from larger storm events to downstream drainage systems. The overflow associated with the 2-year and 15-year design storms must be controlled so that velocities are non-erosive at the outlet point (i.e., to prevent downstream erosion).

Manufactured treatment devices may be constructed on-line or off-line. On-line systems receive upstream runoff from all storms, providing runoff treatment for the stormwater quality design storm and conveying the runoff from larger storms through an overflow. In off-line devices, most or all of the runoff from storms larger than the stormwater quality design storm bypass the device through an upstream diversion or other mechanism.

#### **3.13.3 Proprietary Practice Pretreatment Criteria**

Individual proprietary practices may require pretreatment, or may be appropriate for use as pretreatment devices. Manufacturer's specifications should be consulted to determine the device-specific pretreatment requirements.

#### **3.13.4 Proprietary Practice Design Criteria**

The basic design parameters for a proprietary practice will depend on the techniques it employs to control stormwater runoff and remove particulate and dissolved pollutants from runoff. In general, the design of devices that treat runoff with no significant storage and flow rate attenuation must be based upon the peak design flow rate. However, devices that do provide storage and flow rate attenuation must be based, at a minimum, on the design storm runoff volume and, in some instances, on a routing of the design runoff hydrograph. Hydrologic design is discussed further in Appendix H.

Appendix T includes details of the verification process and the required data submittals for determination of proprietary practice performance.

### **3.13.5 Proprietary Practice Landscaping Criteria**

Proprietary devices may or may not require landscaping considerations. Manufacturer's specifications should be consulted to determine any landscaping requirements for the device.

### **3.13.6 Proprietary Practice Construction Sequence**

The construction and installation of individual proprietary practices will vary based on the specific proprietary practice. Manufacturer's specifications should be consulted to determine the device specific construction sequencing requirements.

### **3.13.7 Proprietary Practice Maintenance Criteria**

In order to ensure effective and long-term performance of a proprietary practice, regular maintenance tasks and inspections are required.

All proprietary practices should be inspected by a qualified professional and maintained in accordance with the manufacturer's instructions and/or recommendations and any maintenance requirements associated with the device's verification by DDOE.

**Declaration of Covenants.** A declaration of covenants that includes all maintenance responsibilities to ensure the continued stormwater performance for the BMP is required. The declaration of covenants specifies the property owner's primary maintenance responsibilities, and authorizes DDOE staff to access the property for inspection or corrective action in the event the proper maintenance is not performed. The declaration of covenants is attached to the deed of the property. An example form is provided at the end of Chapter 5 though variations will exist for scenarios where stormwater crosses property lines. The covenant is between the property and the District Government. It is submitted through the Office of the Attorney General (OAG). All SWMPs have a maintenance agreement stamp that must be signed for a building permit to proceed. A maintenance schedule must appear on the SWMP. Additionally, a maintenance schedule is required in schedule c of the declaration of covenants.

Covenants are not required on government properties, but maintenance responsibilities must be defined through a partnership agreement or a memorandum of understanding.

**Waste Material.** Waste material from the repair, maintenance, or removal of a BMP or land cover shall be removed and disposed of in compliance with applicable federal and District law.

### **3.13.8 Proprietary Practice Stormwater Compliance Calculations**

Proprietary practices will receive no retention value unless explicitly approved by the District. Pollutant removal (TSS EMC reduction) may be awarded for specific practices provided that they meet the performance criteria outlined in Section 3.13.4. Proprietary Practice Design Criteria.

### 3.14 Tree Planting and Preservation

**Definition.** Existing trees can be preserved or new trees can be planted to reduce stormwater runoff.

Tree canopy can intercept a significant amount of rainfall before it becomes runoff, particularly if the tree canopy covers impervious surface, such as in the case of street trees. Through the processes of evapotranspiration and nutrient uptake, trees located on a development site have the capacity to reduce stormwater runoff volumes and improve water quality. Further, through root growth, trees can improve the infiltration capacity of the soils in which they grow.

Both tree planting and tree preservation can contribute to stormwater management on a site.

#### 3.14.1 Preserving Existing Trees During Construction

The preferred method for increasing tree cover at a development site is to preserve existing trees during construction, particularly where mature trees are present. Existing trees are preserved during construction through a four-step process:

- Step 1:** Inventory existing trees.
- Step 2:** Identify trees to preserve.
- Step 3:** Protect trees and soil during construction.
- Step 4:** Protect trees after construction.

**Inventory Existing Trees.** A licensed forester or arborist must conduct an inventory of existing trees and forested areas at the development site before any site design, clearing, or construction takes place, as specified by the Urban Forestry Administration (UFA).

The inventory must include a survey of existing trees and determine their size, species, condition, and ecological value. Locations of trees and forest stands must be recorded.

**Identify Trees to Preserve.** From the tree inventory, individual trees can be identified for preservation and protection during site development. In order to receive retention value, preserved trees must be a species with an average mature spread of at least 35'. Additional selection criteria may include tree species, size, condition, and location (Table 3.52).



**Table 3.52 Selecting Priority Trees and Forests for Conservation**

Selection Criteria for Tree Conservation	Examples of Priority Tree and Forests to Conserve
Species	<ul style="list-style-type: none"> <li>▪ Rare, threatened, or endangered species</li> <li>▪ Specimen trees</li> <li>▪ High quality tree species (e.g., white oaks and sycamores because they are structurally strong and live longer than trees such as silver maple and cottonwood)</li> <li>▪ Species that are tolerant of specific site conditions and soils</li> </ul>
Size	<ul style="list-style-type: none"> <li>▪ Trees over a specified diameter at breast height (d.b.h.) or other size measurement</li> <li>▪ Trees designated as national, state, or local champions</li> <li>▪ Contiguous forest stands of a specified minimum area</li> </ul>
Condition	<ul style="list-style-type: none"> <li>▪ Healthy trees that are structurally sound</li> <li>▪ High quality forest stands with high forest structural diversity</li> </ul>
Location	<ul style="list-style-type: none"> <li>▪ Trees located where they will provide direct benefits at the site (e.g., shading, privacy, windbreak, buffer from adjacent land use)</li> <li>▪ Forest stands that are connected to off-site forests that create wildlife habitat and corridors</li> <li>▪ Trees that are located in protected natural areas such as floodplains, stream buffers, wetlands, erodible soils, critical habitat areas, and steep slopes.</li> <li>▪ Forest stands that are connected to off-site nonforested natural areas or protected land (e.g., has potential to provide wildlife habitat)</li> </ul>

Trees selected for preservation and protection must be clearly marked both on construction drawings and at the actual site. Flagging or fencing are typically used to protect trees at the construction site. Areas of trees to preserve should be marked on the site map and walked during preconstruction meetings.

**Protect Trees and Soil During Construction.** Physical barriers must be properly installed around the Critical Root Zone (CRZ) of trees to be preserved. The CRZ shall be determined by a licensed forester or ISA certified arborist, and in general includes a circular area with a radius (in feet) equal to 15 times the diameter of the trunk (in inches). The barriers must be maintained and enforced throughout the construction process. Tree protection barriers include highly visible, well-anchored temporary protection devices, such as 4-foot fencing, blaze orange plastic mesh fencing, or snow fencing (Greenfeld and others, 1991).

All protection devices must remain in place throughout construction

When excavation is proposed immediately adjacent to the CRZ, roots must first be pruned at the edge of the excavation with a trenching machine, vibratory knife or rock saw to a depth of 18 inches.

**Protect Trees After Construction.** Maintenance covenants, as described below, are required to ensure that preserved trees are protected.

### 3.14.2 Planting Trees

**Considerations at Development Sites.** New development sites provide many opportunities to plant new trees. Planting trees at development sites is done in three steps:

**Step 1:** Select tree species.

**Step 2:** Evaluate and improve planting sites.

**Step 3:** Plant and maintain trees.

**Tree Species.** In order to receive retention value, the tree species planted must have an average mature spread of at least 35 feet. Trees to be planted must be container grown, or ball and burlap, and have a minimum caliper size of 1.5 inches. Bare root trees or seedlings do not qualify for retention value.

**Planting Sites.** Ideal planting sites within a development are those that create interception opportunities around impervious surfaces. These include areas along pathways, roads, islands and median strips, and parking lot interiors and perimeters. Other areas of a development site may benefit from planting trees (including stream valleys and floodplains, areas adjacent to existing forest, steep slopes, and portions of the site where trees would provide buffers, screening, noise reduction, or shading).

It is important to evaluate and record the conditions, such as soil type, soil pH, soil compaction, and the hydrology of proposed planting sites to ensure they are suitable for planting. These evaluations provide a basis for species selection and determination of the need for any special site preparation techniques.

A minimum of 1,500 cubic feet of rootable soil volume must be provided per tree. In planting arrangements that allow for shared rooting space amongst multiple trees, a minimum of 1,000 cubic feet of rootable soil volume must be provided for each tree. Rootable soil volume must be within 3 feet of the surface.

Site characteristics determine what tree species will flourish there and whether any of the conditions, such as soils, can be improved through the addition of compost or other amendments. Table 3.53 presents methods for addressing common constraints to urban tree planting.

**Table 3.53 Methods for Addressing Urban Planting Constraints**

Potential Impact	Potential Resolution
Limited Soil Volume	<ul style="list-style-type: none"> <li>▪ Provide 1,500 cubic feet of rootable soil volume per tree</li> <li>▪ Use planting arrangements that allow shared rooting space. A minimum of 1,000 cubic feet of rootable soil volume must be provided for each tree in shared rooting space arrangements.</li> <li>▪ Provide 1500 cubic feet of rootable soil volume per tree (this soil must be within 3 feet of the surface)</li> </ul>
Poor Soil Quality	<ul style="list-style-type: none"> <li>▪ Test soil and perform appropriate restoration</li> <li>▪ Select species tolerant of soil pH, compaction, drainage, etc.</li> <li>▪ Replace very poor soils if necessary</li> </ul>
Air Pollution	Select species tolerant of air pollutants
Damage from Lawnmowers	Use mulch to protect trees
Damage from Vandalism	<ul style="list-style-type: none"> <li>▪ Use tree cages or benches to protect trees</li> <li>▪ Select species with inconspicuous bark or thorns</li> <li>▪ Install lighting nearby to discourage vandalism</li> </ul>
Damage from Vehicles	Provide adequate setbacks between vehicle parking stalls and trees
Damage from animals such as deer, rodents, rabbits, and other herbivores	Use protective fencing or chemical retardants
Exposure to pollutants in stormwater and snowmelt runoff	Select species that are tolerant of specific pollutants, such as salt and metals
Soil moisture extremes	<ul style="list-style-type: none"> <li>▪ Select species that are tolerant of inundation or drought</li> <li>▪ Install underdrains if necessary</li> <li>▪ Select appropriate backfill soil and mix thoroughly with site soil</li> <li>▪ Improve soil drainage with amendments and tillage if needed</li> </ul>
Increased temperature	Select drought tolerant species
Increased wind	Select drought tolerant species
Abundant populations of invasive species	<ul style="list-style-type: none"> <li>▪ Control invasive species prior to planting</li> <li>▪ Continually monitor for and remove invasive species</li> </ul>
Conflict with infrastructure	<ul style="list-style-type: none"> <li>▪ Design the site to keep trees and infrastructure separate</li> <li>▪ Provide appropriate setbacks from infrastructure</li> <li>▪ Select appropriate species for planting near infrastructure</li> <li>▪ Use alternative materials to reduce conflict</li> </ul>
Disease or insect infestation	Select resistant species

Planting trees at development sites requires prudent species selection, a maintenance plan, and careful planning to avoid impacts from nearby infrastructure, runoff, vehicles or other urban elements.

**Trees Along Streets and in Parking Lots.** When considering a location for planting clear lines of sight must be provided, as well as safe travel surfaces, and overhead clearance for pedestrians and vehicles. Also, ensure enough future soil volume for healthy tree growth. At least two cubic feet of useable soil per square foot of average mature tree canopy is required. (Useable soil must be uncompacted, and may not be covered by impervious material). Having at least a 6-foot wide

planting strip or locating sidewalks between the trees and street allows more rooting space for trees in adjacent property.

Select tree species that are drought tolerant, can grow in poor or compacted soils, and are tolerant to typical urban pollutants (oil and grease, metals, and chlorides). Additionally, select species that do not produce excessive fruits, nuts, or leaf litter, that have fall color, spring flowers or some other aesthetic benefit, and can be limbed up to 6 feet to provide pedestrian and vehicle traffic underneath. The District Department of Transportation, Urban Forestry Administration (DDOT UFA) provides guidance on preferred street tree species based on neighborhoods.

**Planting Techniques.** Prepare a hole no deeper than the root ball or mass but two to three times wider than the spread of the root ball or mass. The majority of the roots on a newly planted tree will develop in the top 12 inches of soil and spread out laterally. There are some additional considerations depending on the type of plant material being used (Table 3.54).

**Table 3.54 Tree Planting Techniques**

Plant Material	Planting Technique	Planting Season
Container grown	Hand plant or use mechanical planting tools (e.g., auger)	Spring or fall, summer if irrigated
Balled and burlapped	Use backhoe (or other specialized equipment) or hand plant	Spring or fall

Source: Palone and Todd (1998), WSAHGP (2002), NJDEP (2004)

One of the most important planting guidelines is to make sure the tree is not planted too deeply. The root collar, the lowest few inches of trunk just above its junction with the roots (often indicated by a flare), should be exposed (Flott, 2004). Trees planted too deeply have buried root collars, and are weakened, stressed, and predisposed to pests and disease (Flott, 2004). Trees planted too deeply can also form adventitious roots near the soil surface in an attempt to compensate for the lack of oxygen available to buried roots. Adventitious roots are not usually large enough to provide support for a large tree and may eventually lead to collapse (Flott, 2004). ISA (2005) provides additional guidance on how to avoid planting too deeply. It is generally better to plant the tree a little high, that is, with the base of the trunk flare 2 to 3 inches above the soil, rather than at or below the original growing level (ISA, 2003b).

Proper handling during planting is essential to avoid prolonged transplant shock and ensure a healthy future for new trees and shrubs. Trees should always be handled by the root ball or container, never by the trunk. Specifications for planting a tree are illustrated in Figure 3.42. Trees must be watered well after planting.

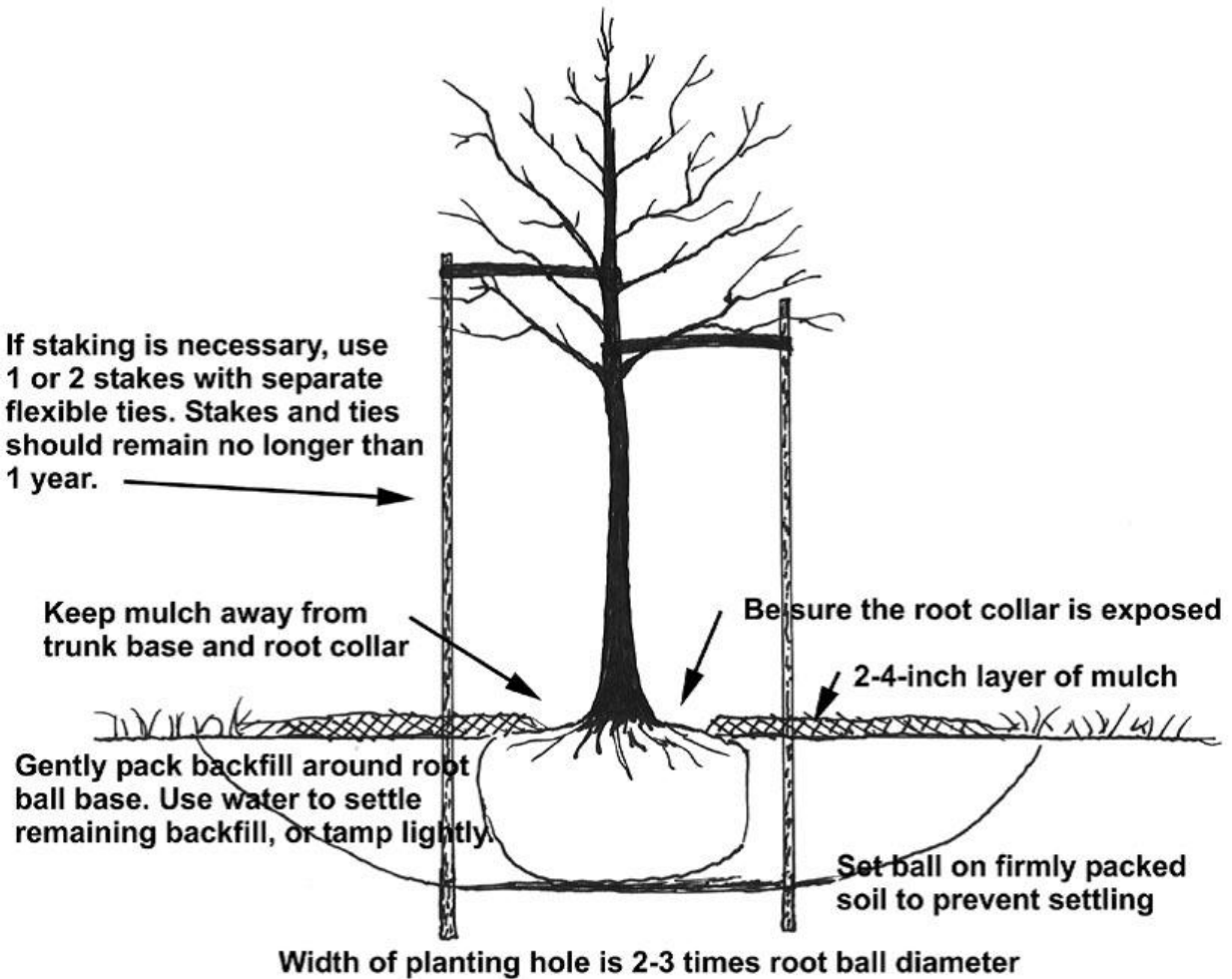


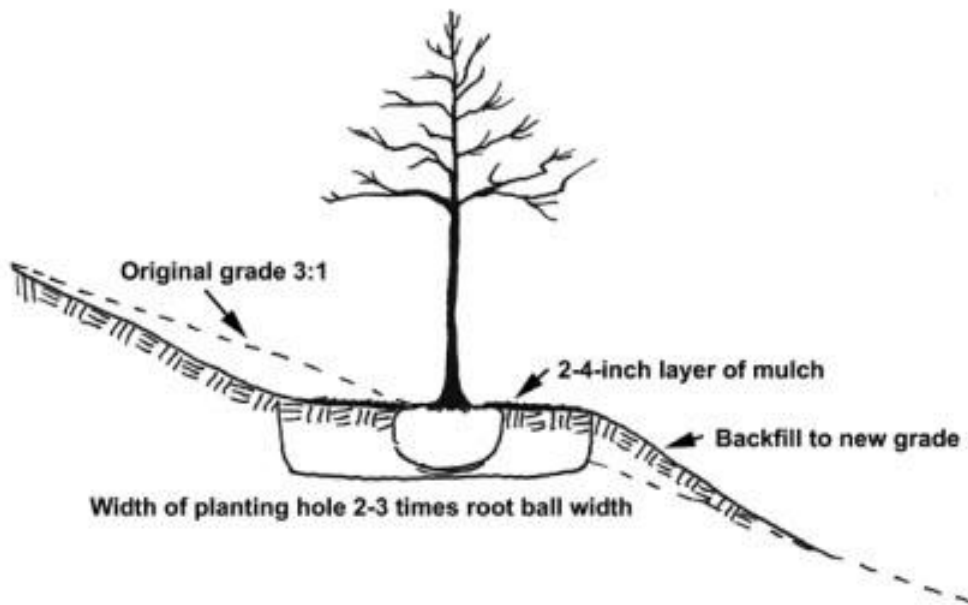
Figure 3.42 Tree planting guidelines. (Adapted from Flott, 2004 and ISA, 2003b).

Steep slopes require additional measures to ensure planting success and reduce erosion, especially if the slope receives stormwater runoff from upland land uses. Depending on the steepness of the slope and the runoff volume, rill or gully erosion may occur on these slopes, requiring a twofold approach: controlling the stormwater and stabilizing the slope.

Erosion control blankets are recommended to temporarily stabilize soil on slopes until vegetation is established (Caraco, 2000; Morrow and others, 2002). Erosion control fabrics come in a variety of weights and types, and should be combined with vegetation establishment such as seeding. Other options for stabilizing slopes include applying compost or bark mulch, plastic sheeting, or sodding (Caraco, 2000).

Trees will add stability to slopes because of their deep roots, provided they are not planted by digging rows of pits across a slope (Morrow and others, 2002). Required maintenance will include mowing (if slopes are not too steep), and establishing cover on bare or eroded areas.

Planting methods for slopes steeper than 3:1 (1 foot vertical change for every 3 horizontal feet) involve creating a level planting space on the slope (see Figure 3.43). A terrace can be dug into the slope in the shape of a step. The existing slope can be cut and the excavated soil can be used as fill. A low soil berm (or rock berm) can be formed at the front edge of each step or terrace to slow the flow of water. Trees can also be planted in clusters on slopes (using the above method) to limit potential for desiccation. Staggering tree placement and mulching will prevent water from running straight downhill.



**Figure 3.43** The specifications for planting on a steep slope, require creating a level planting surface.

**Post-Planting Tree Protection.** Once the tree has been properly planted, 2 to 4 inches of organic mulch must be spread over the soil surface out to the drip line of the tree. If planting a cluster of trees, mulch the entire planting area. Slow-decomposing organic mulches, such as shredded bark, compost, leaf mulch, or wood chips provide many added benefits for trees. Mulch that contains a combination of chips, leaves, bark, and twigs is ideal for reforestation sites. (ACB, 2000; ISA, 2003a). Grass clippings and sawdust are not recommended as mulches because they decompose rapidly and require frequent application, resulting in reduced benefits.

For well-drained sites up to 4 inches of mulch may be applied, and for poorly drained sites a thinner layer of mulch should be applied. Mulch should never be more than 4 inches deep or applied right next to the tree trunk; however, a common sight in many landscaped areas is the “mulch volcano”. This over-mulching technique can cause oxygen and moisture-level problems, and decay of the living bark at the base of the tree. A mulch-free area, 2- to 3-inches wide at the base of the tree, must be provided to avoid moist bark conditions and prevent decay (ISA, 2003a).

Studies have shown that trees will establish more quickly and develop stronger trunk and root systems if they are not staked at the time of planting (ISA, 2003b). Staking for support may be necessary only for top-heavy trees or at sites where vandalism or windy exposure are a concern (Buckstrup and Bassuk, 2003; Doherty and others, 2003; ISA, 2003b).

If staking is necessary for support, two stakes used in conjunction with a wide flexible tie material will hold the tree upright, provide flexibility, and minimize injury to the trunk. To prevent damage to the root ball, stakes should be placed in undisturbed soil beyond the outer edges of the root ball. Perhaps the most important part of staking is its removal. Over time, guy wires (or other tie material) can cut into the growing trunk bark and interfere with the movement of water and nutrients within the tree. Staking material should be removed within 1 year of planting (Doherty and others, 2003).

### **3.14.3 Tree Inspection Criteria**

An initial inspection by a qualified professional must be done to ensure the tree has been planted, watered, and protected correctly with locations flagged if appropriate. For newly planted trees, transplant shock is common and causes stress on a new tree. For this reason, newly planted trees must be inspected more frequently than established trees. The time it takes for a tree to become established varies with the size at planting, species, stock, and site conditions, but generally, trees should be inspected every few months during the first 3 years after planting, to identify problems and implement repairs or modify maintenance strategies (WSAHGP, 2002).

After the first 3 years, annual inspections are sufficient to check for problems. Trees must also be inspected after major storm events for any damage that may have occurred. The inspection should take only a few minutes per tree, but prompt action on any problems encountered results in healthier, stronger trees. Inspections should include an assessment of overall tree health, an assessment of survival rate of the species planted, cause of mortality, if maintenance is required, insect or disease problems, tree protection adjustment, and weed control condition.

DDOE's construction phase inspection checklist for tree planting and preservation can be found in Appendix L.

### **3.14.4 Tree Maintenance Criteria**

Water newly planted trees regularly (at least once a week) during the first growing season. Water trees less frequently (about once a month) during the next two growing seasons. After three growing seasons, water trees only during drought. The exact watering frequency will vary for each tree and site.

A general horticultural rule of thumb is that trees need 1 inch of rainfall per week during the growing season (Petit and others, 1995). This means new trees need a minimum of 25 gallons of water a week to stay alive (<http://caseytrees.org/get-involved/water/>). Water trees deeply and slowly near the roots. Light, frequent watering of the entire plant can actually encourage roots to grow at the surface. Soaker hoses and drip irrigation work best for deep watering of trees. It is recommended that slow leak watering bags or tree buckets are installed to make watering easier and more effective. Continue watering until mid-fall, tapering off during lower temperatures.

Pruning is usually not needed for newly planted trees but may be beneficial for tree structure. If necessary, prune only dead, diseased, broken or crossing branches at planting (Doherty and others, 2003; Trowbridge and Bassuk, 2004). As the tree grows, lower branches may be pruned to provide clearance above the ground, or to remove dead or damaged limbs.

DDOE’s maintenance inspection checklist for tree planting and preservation can be found in Appendix M.

**Declaration of Covenants.** A maintenance covenant is required for all stormwater management practices. The covenant specifies the property owner’s primary maintenance responsibilities, and authorizes DDOE staff to access the property for inspection or corrective action in the event the proper maintenance is not performed. The covenant is attached to the deed of the property (see standard form, variations exist for scenarios where stormwater crosses property lines). The covenant is between the property and the District Government. It is submitted through the Office of the Attorney General. All SWMPs have a maintenance agreement stamp that must be signed for a building permit to proceed. There may be a maintenance schedule on the drawings themselves or the plans may refer to the maintenance schedule (schedule c in the covenant).

Covenants are not required on government properties, but maintenance responsibilities must be defined through a partnership agreement or a memorandum of understanding.

**Waste Material.** Waste material from the repair, maintenance, or removal of a BMP or land cover shall be removed and disposed of in compliance with applicable federal and District law.

### 3.14.5 Tree Stormwater Compliance Calculations

To ensure appropriate stormwater benefits associated with proposed tree preservation or planting, all trees receiving retention value must be properly maintained until redevelopment of the area occurs. If trees die they must be replaced with a similar tree no longer than 6 months from time of death in an appropriate location.

Preserved trees that meet the requirements described above receive a retention value of 20 cubic feet each. Planted trees that meet the requirements described above receive a retention value of 10 cubic feet each. Note: Trees planted as part of another BMP, such as a bioretention area, also receive the 10 cubic foot retention value. Retention values are shown in Tables 3.55 and 3.56 below.

**Table 3.55 Preserved Tree Retention Value and Pollutant Removal**

Retention Value	= 20cf
Accepted TSS Treatment Practice	No



**Table 3.56 Planted Tree Retention Value and Pollutant Removal**

Retention Value	= 10cf
Accepted TSS Treatment Practice	No

Trees also contribute to peak flow reduction. This contribution can be determined in several ways. One method is to subtract the retention value from the total runoff volume for the 2-year, 15-year, and 100-year storms. The resulting reduced runoff volumes can then be used to calculate a Reduced Natural Resource Conservation Service (NRCS) Curve Number for the site or drainage area. The Reduced Curve Number can then be used to calculate peak flow rates for the various storm events. Other hydrologic modeling tools that employ different procedures may be used as well.

### 3.14.6 References

- Alliance for the Chesapeake Bay (ACB). 2000. Pennsylvania Stream ReLeaf forest buffer toolkit. Harrisburg, PA: Pennsylvania Department of Environmental Protection.
- Arendt, R. G. 1996. Conservation design for subdivisions. A practical guide to creating open space networks. Washington, DC: Island Press. 184 p.
- Bassuk, N.; Curtis, D. F.; Marranca, B. Z.; Neal, B. 2003. Recommended urban trees: site assessment and tree selection for stress tolerance. Ithaca, NY: Cornell University, Urban Horticulture Institute. 127 p. [www.hort.cornell.edu/uhi](http://www.hort.cornell.edu/uhi) (Accessed December 28, 2005).
- Buckstrup, M.; Bassuk, N. 2000. Transplanting success of balled-and-burlapped versus bare-root trees in the urban landscape. *Journal of Arboriculture* 26(6): 298-308.
- Cappiella, K.; Schueler, T.; Wright, T. 2006. Urban Watershed Forestry Manual. United States Department of Agriculture Forest Service. Newtown Square, PA.
- Caraco, D. 2000. Keeping soil in its place. In: Schueler, T.; Holland, H., eds. *The practice of watershed protection*. Ellicott City, MD; 323-328.
- Center for Watershed Protection. 1998. *Better site design: a handbook for changing development rules in your community*. Ellicott City, MD. 174 p.
- Cornell University. 2004. *Conducting a street tree inventory*. Ithaca, NY: Cornell University, Department of Horticulture. [www.hort.cornell.edu/commfor/inventory/index.html](http://www.hort.cornell.edu/commfor/inventory/index.html) (Accessed December 28, 2005).
- Doherty, K.; Bloniarz, D.; Ryan, H. 2003. Positively the pits: successful strategies for sustainable streetscapes. *Tree Care Industry* 14(11): 34-42. [www.umass.edu/urbantree/publications/pits.pdf](http://www.umass.edu/urbantree/publications/pits.pdf) (Accessed 2006).
- Flott, J. 2004. Proper planting begins below ground. *TreeLink* 19: 1-4.

- Georgia Forestry Commission (GFC). 2002. Community tree planting and establishment guidelines. Dry Branch, GA.
- Gilman, E. F. 1997. Trees for urban and suburban landscapes. Albany, NY: Delmar Publishers.
- Greenfeld, J.; Herson, L.; Karouna, N.; Bernstein, G. 1991. Forest conservation manual: guidance for the conservation of Maryland's forests during land use changes, under the 1991 Forest Conservation Act. Washington, DC: Metropolitan Washington Council of Governments. 122 p.
- Hairston-Strang, A. 2005. Riparian forest buffer design and maintenance. Annapolis: Maryland Department of Natural Resources.
- Head, C.; Robinson, F.; O'Brien, M. 2001. Best management practices for community trees: a guide to tree conservation in Athens-Clarke County, Georgia. Athens, GA: Athens-Clarke County Unified Government.
- International Society of Arboriculture (ISA). 2005. Avoiding excessive soil over the root systems of trees. *Arborist News*, April.
- International Society of Arboriculture (ISA). 2003a. Proper mulching techniques. Champaign, IL: International Society of Arboriculture. [www.treesaregood.com/treecare/mulching.aspx](http://www.treesaregood.com/treecare/mulching.aspx) (Accessed 2006).
- International Society of Arboriculture (ISA). 2003b. New tree planting. Champaign, IL: International Society of Arboriculture. [www.treesaregood.com/treecare/tree\\_planting.aspx](http://www.treesaregood.com/treecare/tree_planting.aspx) (Accessed 2006).
- Johnson, G. R. 2005. Protecting trees from construction damage: a homeowner's guide. St. Paul, MN: Regents of the University of Minnesota. [www.extension.umn.edu/distribution/housingandclothing/DK6135.html](http://www.extension.umn.edu/distribution/housingandclothing/DK6135.html) (Accessed December 28, 2005).
- Kochanoff, S., 2002. Trees vs. power lines: priorities and implications in Nova Scotia. Presented at the 5th Annual Canadian Urban Forest Conference. Markham, ON.
- Maryland National Capital Parks and Planning Commission. 1992. Trees. Approved Technical Manual. Maryland National Capital Parks and Planning Commission, Montgomery County, MD. 144 p. [http://www.montgomeryplanning.org/environment/forest/trees/toc\\_trees.shtm](http://www.montgomeryplanning.org/environment/forest/trees/toc_trees.shtm)
- Meyer, D. 1993. Tree shelters for seedling protection and increased growth. *Forestry Facts* 59. Madison, WI: University of Wisconsin Extension.
- Minnesota Department of Natural Resources. 2000. Conserving wooded areas in developing communities. BMPs in Minnesota. Minnesota Department of Natural Resources, St. Paul, MN. 113 p. [www.dnr.state.mn.us/forestry/urban/bmps.html](http://www.dnr.state.mn.us/forestry/urban/bmps.html) (Accessed December 28, 2005).

- Morrow, S.; Smolen, M.; Stiegler, J.; Cole, J. 2002. Using vegetation for erosion control. *Landscape Architect* 18(11): 54-57.
- Nebraska Forest Service. 2004. Tree selection and placement. Storm Damage Bulletin No. 7. <http://digitalcommons.unl.edu/cgi/viewcontent.cgi?article=1068&context=nebforestpubs>
- Palone, R. S.; Todd, A. H., eds. 1998. Chesapeake Bay riparian handbook: a guide for establishing and maintaining riparian forest buffers. NA-TP-02-97. Radnor, PA: USDA Forest Service, Northeastern Area State and Private Forestry.
- Pennsylvania State University. 1999. A guide to preserving trees in development projects. University Park, PA: Penn State College of Agricultural Sciences, Cooperative Extension. 27 p.
- Pennsylvania State University (PSU). 1997. Questions about trees and utilities. Forestry Fact Sheet #7. University Park: Pennsylvania State University, College of Agricultural Sciences.
- Petit, J.; Bassert, D. L.; Kollin, C. 1995. Building greener neighborhoods. Trees as part of the plan. Washington, DC: American Forests and the National Association of Homebuilders.
- Schueler, T. R. 1995. Site planning for urban stream protection. Ellicott City, MD: Center for Watershed Protection. 232 p.
- Schueler, T.; Brown, K. 2004. Urban stream repair practices. Version 1.0. Manual 4 of the Urban Subwatershed Restoration Manual Series. Ellicott City, MD: Center for Watershed Protection.
- Sweeney, B. W. 1993. Effects of streamside vegetation on macroinvertebrate communities of White Clay Creek in Eastern North America. In: Proceedings of the Academy of Natural Sciences of Philadelphia. Philadelphia, PA; 291-340.
- Tree Care Industry Association (TCIA). 2004. ANSI A300 Standards for tree care operations. Manchester, NH; [www.natlarb.com/content/laws/a-300.htm](http://www.natlarb.com/content/laws/a-300.htm) (Accessed 2005).
- Trowbridge, P.; Bassuk, N. 2004. Trees in the urban landscape: site assessment, design, and installation. Hoboken, NJ: John Wiley & Sons, Inc.
- USDA Forest Service. 1998. Volunteer training manual. Amherst, MA: Northeast Center for Urban and Community Forestry. 86 p. [www.umass.edu/urbantree/volmanual.pdf](http://www.umass.edu/urbantree/volmanual.pdf) (Accessed December 28, 2005).
- Washington State Aquatic Habitat Guidelines Program (WSAHGP). 2002. Integrated streambank protection guidelines. Olympia, WA. Unpaginated.



## Chapter 4                    **Selecting and Locating the Most Effective Stormwater Best Management Practice System**

### **4.1    Choosing Stormwater Management Best Practices (BMPs)**

This chapter outlines a general process for selecting appropriate BMPs at a development site. Guidelines are presented for choosing which BMPs can meet the retention and treatment volume targets for design storms and which BMPs are most feasible when various site constraints are present. The method involves a five-step screening process for the following factors:

- Step 1:**    Stormwater Management Suitability
- Step 2:**    Land Use Factors
- Step 3:**    Physical Feasibility Factors
- Step 4:**    Community and Environmental Factors
- Step 5:**    Location and Permitting Considerations

The factors presented in this chapter represent guidelines, not rules, for which BMP may be most appropriate at a site. It is important to note that certain BMP design modifications or specific site characteristics may allow for a particular BMP to become better suited at a particular location. Several of these design modifications are noted in the tables below and are described in more detail in the individual practice specifications (see Chapter 3).

The general step-wise screening process is described below.

#### **Step 1:    Stormwater Management Suitability**

*Can the BMP meet all stormwater sizing criteria at the site or are a combination of BMPs needed?*

In this step, designers can screen BMP options using Matrix No. 1 to determine if a particular BMP can meet the SWRV, Qp2, Qp15, and/or Qf storage requirements. In addition, the designer can view the pollutant removal potential for select pollutants to determine the best BMP options for water quality improvements. At the end of this step, the designer can screen the BMP options down to a manageable number and determine if a single BMP or a group of BMPs are needed to meet stormwater sizing criteria at the site.

**Step 2: Land Use Factors**

*Which practices are best suited for the proposed land use at this site?*

In this step, the designer can use Matrix No. 2 to screen select practices that are best suited to a particular land use, including highly urbanized areas.

**Step 3: Physical Feasibility Factors**

*Are there any physical constraints at the project site that may restrict or preclude the use of a particular BMP?*

In this step, the designer can screen BMP options using Matrix No. 3 to determine if the soils, water table, drainage area, slope or head conditions present at a particular development site might limit the use of a BMP.

**Step 4: Community and Environmental Factors**

*Do the remaining BMPs have any important community or environmental benefits or drawbacks that might influence the selection process?*

In this step, Matrix No. 4 is used to compare the BMP options with regard to maintenance, habitat, community acceptance, cost, safety, space consumption, and other environmental factors.

**Step 5: Location and Permitting Considerations**

*What environmental features must be avoided or considered when locating the BMP system at a site to fully comply with District and federal regulations?*

In this step, the designer follows an environmental features checklist that asks whether any of the following are present at the site: wetlands, waters of the United States, floodplains, and development infrastructure. Brief guidance is then provided on how to locate BMPs to avoid impacts to sensitive resources. If a BMP must be located within a sensitive environmental area, a brief summary of applicable permit requirements is provided.

## **4.2 Stormwater Management Suitability**

The first matrix (Table 4.1) examines the capability of each Stormwater Best Management Practice (BMP) option to meet the stormwater management sizing criteria outlined in Chapter 2. Thus, it shows whether a BMP has the

**Ability to Meet the Stormwater Retention Volume (SWRv)**, It should be noted that not all practices are capable of meeting the SWRv requirement. Thus, if a single BMP cannot meet this requirement, the matrix can help identify supplemental practices that can.

**Ability to Provide Additional Quantity Control (Qp2, Qp15 and/or Qf)**. The matrix shows whether a BMP can typically meet the peak discharge requirement for the site. Again, the finding that a particular BMP cannot meet the requirement does not necessarily mean that it should be

eliminated from consideration, but rather, is a reminder that more than one practice may be needed at a site (e.g., a bioretention area and a downstream storage practice).

**Pollutant Removal.** The matrix examines the capability of each BMP option to remove Total Suspended Solids (TSS) from stormwater runoff.

Note: Table 4.1 should be used as a guide for how practices typically perform. Individual designs may be sized or designed with greater or lesser capabilities than is indicated in the table.

**Table 4.1 BMP Selection Based on Regulatory Goals**

Code	BMP	SWRv Storage	Q <sub>p2</sub> /Q <sub>p15</sub> Control	Q <sub>f</sub> Control	TSS Removal
G-1	Extensive Green Roof	●	⊙	☒	N/A
G-2	Intensive Green Roof		⊙		
R-1	Rainwater Harvesting	⊙	⊙	☒	N/A
D-1	Simple disconnection to a pervious area	⊙	☒	☒	NO
D-2	Simple disconnection to a conservation area				
D-3	Simple disconnection to a soil compost amended				
P-1	Porous Asphalt	●	⊙	☒	N/A or YES*
P-2	Pervious Concrete				
P-3	Permeable Pavers				
B-1	Traditional bioretention	●	⊙	☒	N/A or YES*
B-2	Streetscape bioretention		⊙		
B-3	Expanded tree pits		⊙		
B-4	Stormwater planters		⊙		
B-5	Residential rain gardens		⊙		
F-1	Surface SF	☒	☒	☒	YES
F-2	1-Chamber Underground SF				
F-3	3-Chamber Underground SF				
F-4	Perimeter SF				
I-1	Infiltration Trench	●	⊙	☒	N/A
I-2	Infiltration Basin				
O-1	Grass Channels	⊙	☒	☒	NO
O-2	Dry Swale	●			YES
O-3	Wet Swale	☒			YES
P-1	Micropool ED Pond	☒	●	●	YES
P-2	Wet Pond				
P-3	Wet ED Pond				
W-1	Shallow Wetland	☒	●	●	YES
W-2	ED Shallow Wetland				

Code	BMP	SWR <sub>v</sub> Storage	Q <sub>p2</sub> /Q <sub>p15</sub> Control	Q <sub>f</sub> Control	TSS Removal
S-1	Underground Detention	☒	●	●	NO
S-2	Dry ED Pond				
PP-1	Proprietary Practice	☒	☒	☒	YES
TP-1	Tree Preservation	⊙	☒	☒	NO
TP-2	Tree Planting				

● = Yes; ⊙ = Partial; ☒ = Minor or No Benefit

\* Depends upon design type.

**Residential.** This column identifies the best treatment options in medium to high density residential developments.

**Commercial Development.** This column identifies practices that are suitable for new commercial development.

**Roads and Highways.** This column identifies the best practices to treat runoff from major roadway and highway systems.

**Hotspot Land Uses.** This column examines the capability of BMPs to treat runoff from designated hotspots. BMPs that receive hotspot runoff may have design restrictions, as noted.

The second matrix (Table 4.2) allows the designer to make an initial screening of practices most appropriate for a given land use.

### 4.3 Land Use Factors

**Table 4.2 BMP Selection Based on Land Use Screening Factors**

Code	BMP	Residential	Commercial	Roads and Highways	Hotspots
G-1	Extensive Green Roof	⊙	●	☒	☒
G-2	Intensive Green Roof				
R-1	Rainwater Harvesting	●	●	☒	☒
D-1	Simple disconnection to a pervious area	●	●	⊙	☒
D-2	Simple disconnection to a conservation area				
D-3	Simple disconnection to a soil compost amended filter path				
P-1	Porous Asphalt	⊙	●	①	☒
P-2	Pervious Concrete				
P-3	Permeable Pavers				
B-1	Traditional bioretention	●	●	⊙	②
B-2	Streetscape bioretention		●	●	
B-3	Expanded tree pits		●	●	
B-4	Stormwater planters		●	☒	



Code	BMP	Residential	Commercial	Roads and Highways	Hotspots
B-5	Residential rain gardens		☒	☒	
F-1	Surface SF			●	
F-2	1-Chamber Underground SF	☒	●	⊙	●
F-3	3-Chamber Underground SF			⊙	
F-4	Perimeter SF			⊙	
I-1	Infiltration Trench	⊙	●	⊙	☒
I-2	Infiltration Basin				
O-1	Grass Channel	●	●	●	②
O-2	Dry Swale				
O-3	Wet Swale				
P-1	Micropool ED Pond	●	⊙	⊙	③
P-2	Wet Pond				
P-3	Wet ED Pond				
W-1	Shallow Wetland	●	●	⊙	③
W-2	ED Shallow Wetland				
S-1	Underground Detention	☒	●	●	☒
S-2	Dry Pond	●	●	⊙	
PP-1	Proprietary Practice	●	●	●	●
TP-1	Tree Preservation	●	●	●	●
TP-2	Tree Planting				

- = Yes; ⊙ = Maybe; ☒ = No
- ①- Recommended for low volume roads or parking lanes
- ②-Yes, only if designed with an impermeable liner
- ③-May require pond liner to reduce the risk of GW contamination

#### 4.4 Physical Feasibility Factors

At this point, the designer has narrowed the BMP selection list based on regulatory goals and land use constraints. Now, the designer can evaluate the remaining BMP options given the actual physical conditions of a site. The matrix in Table 4.4 identifies the typical physical conditions needed for each type of BMP. As noted above, these factors are intended as guidelines rather than requirements. There are five primary factors:

1. **Underlying Soils.** The key evaluation factors are based on an initial investigation of the NRCS hydrologic soils groups at the site. Note: More detailed geotechnical tests are required to evaluate infiltration feasibility and related design parameters. Once the infiltration rate at a site has been measured, Table 4.3 can help determine the recommended design criteria for practices that have an infiltration option.

**Table 4.3 Infiltration Design Choices Based on Measured Infiltration Rate\***

Measured Infiltration Rate (in./hr)			
	Less than 0.25	0.25 to 0.5	More than 0.5
<b>Recommended Design Solution</b>	Use Bioretention, Dry Swale, or Permeable Pavement (likely with an underdrain).  Do not use Infiltration Trench/Basin.	Use Bioretention, Dry Swale, or Permeable Pavement (likely with an underdrain) May be beneficial to include an infiltration sump below the underdrain invert.  Infiltration Trench/Basin may not be appropriate.	Use Infiltration Trench/Basin, Bioretention, Dry Swale, or Permeable Pavement without an underdrain.

\*Designers must use ½ of the measured infiltration rate for design purposes, as indicated in the design equations given in Chapter 3.

- Water Table Depth.** This column indicates the minimum depth to the seasonally high water table from the bottom or floor of a BMP.
- Contributing Drainage Area.** This column indicates the minimum or maximum drainage area that is considered suitable for the practice. If the drainage area present at a site is slightly greater than the maximum allowable drainage area for a practice, some leeway is permitted. Likewise, the minimum drainage areas indicated for ponds and wetlands should not be considered inflexible limits, and may be increased or decreased depending on water availability (baseflow or groundwater) or the mechanisms employed to prevent clogging or ensure an impermeable pond bottom.
- Practice Surface Slope.** This column evaluates the effect of slope on the practice. Specifically, the slope restrictions refer to how flat the area where the practice is installed must be.
- Head.** This column provides an estimate of the elevation difference needed at a site (from the inflow to the outflow) to allow for gravity operation within the practice.

**Table 4.4 Physical Feasibility Screening Factors**

Code	BMP List	Underlying Soils	Water Table Depth (ft)	Contributing Drainage Area (ac)	Practice Surface Slope (%)	Head (ft)
G-1	Extensive Green Roof	N/A	N/A	green roof surface area + 25%	1–2 <sup>a</sup>	N/A
G-2	Intensive Green Roof					
R-1	Rainwater Harvesting	N/A	N/A	no limit	N/A	N/A
D-1	Simple disconnection to a pervious area	all soils	N/A	< 1,000 ft <sup>2</sup> per rooftop downspout <sup>b</sup>	< 5	N/A
D-2	Simple disconnection to a conservation area				< 6	
D-3	Simple disconnection to a soil compost amended filter path				< 5	
P-1	Porous Asphalt	all soils (i < 0.5 in./hr)	2	2–5 × practice surface area	< 5	2–4
P-2	Pervious Concrete					

Code	BMP List	Underlying Soils	Water Table Depth (ft)	Contributing Drainage Area (ac)	Practice Surface Slope (%)	Head (ft)
P-3	Permeable Pavers	may require underdrains)				
B-1	Traditional bioretention	all soils (i < 0.5 in./hr may require underdrains)	2	< 2.5	< 1	4–5 ft <sup>c</sup>
B-2	Streetscape bioretention			< 1		
B-3	Expanded tree pits			< 1		
B-4	Stormwater planters			< 1		
B-5	Residential rain gardens			< 1		
F-1	Surface SF	all soils	2	< 5	N/A	5
F-2	1-Chamber Underground SF			< 10,000 ft <sup>2</sup>		5–10
F-3	3-Chamber Underground SF			< 2		5–10
F-4	Perimeter SF			< 2		2–3
I-1	Infiltration Trench	i > 0.5 in/hr is preferred	2	< 2	< 1	2
I-2	Infiltration Basin			< 5		
O-1	Grass Channel	all soils	2	< 2.5	< 4	1
O-2	Dry Swale	all soils (i < 0.5 in./hr may require underdrains)	2			3–5
O-3	Wet Swale	i < 0.5 inch/hr	intersect WT			1
P-1	Micropool ED Pond	soils i > 0.5 in./hr may require pond liner	N/A	10-25	< 1	6–8
P-2	Wet Pond		N/A	10-25		6–8
P-3	Wet ED Pond		N/A	10-25		6–8
W-1	Shallow Wetland	soils i > 0.5 in./hr may require pond liner	N/A	> 25 <sup>e</sup>	< 1	2–4
W-2	ED Shallow Wetland		N/A			
S-1	Underground Detention	all soils	no restrictions	no restrictions <sup>d</sup>	< 1	> 5
S-2	Dry ED Pond		2	> 10 <sup>d</sup>	< 1	6–8
PP-1	Proprietary Practice	All soils	2	design dependent	N/A	2-5
TP-1	Tree Preservation	All soils	N/A	N/A	N/A	N/A
TP-2	Tree Planting		N/A	N/A		

i= infiltration rate or permeability, WT= water table, N/A= not applicable

<sup>a</sup> Green roof slope can be up to 25% if baffles are used to ensure detention of the design storm

<sup>b</sup> For non-rooftop impervious areas, the longest contributing impervious area flow path cannot exceed 75 feet.

<sup>c</sup> The required head for bioretention areas can be reduced in small applications or when an upturned or elevated underdrain design is used

<sup>d</sup> No limit but practical drainage area limitations may exist due to minimum orifice size (e.g., 1-inch diameter with internal orifice)

<sup>e</sup> CDA can be smaller if the practice intersects the water table

## 4.5 Community and Environmental Factors

The fourth step considers community and environmental factors involved in BMP selection. This matrix (Table 4.4) employs a comparative index approach. The table indicates whether a BMP has a high, medium, or low benefit in each of four categories. A fifth category includes miscellaneous factors to consider.

**Maintenance Burden.** This column assesses the relative maintenance effort needed for a BMP, in terms of three criteria: frequency of scheduled maintenance, chronic maintenance problems (such as clogging) and reported failure rates. It should be noted that all BMPs require routine inspection and maintenance (maintenance checklists for all BMPs can be found in Appendix M).

**Cost.** The BMPs are ranked according to their relative construction cost per cubic foot of stormwater retained as determined from cost surveys and local experience.

**Safety Risk.** A comparative index is provided to express the potential safety risk of a BMP when designed according to the performance criteria outlined in Chapter 3. The index is included at this stage of the screening process to highlight the need for considerations of liability and public safety in locations, such as residential, public space, schools, and others. A comparatively higher risk BMP may require signage, fencing, or other measures, needed to alert the general public or maintenance provider of a potentially harmful situation.

**Space Required.** This comparative index expresses how much space a BMP typically consumes at a site. Again, this factor is included in this early screening stage because many BMPs are constrained by availability of open land.

**Environmental Factors.** This column assesses the range of environmental factors considered under the Green Area Ratio (GAR) process to identify the broader human and environmental beneficial intersections some BMPs provide. For instance some BMPs contribute to air quality improvements, and reductions in the urban heat island effect.

**Habitat Value.** BMPs are evaluated on their ability to provide wildlife or wetland habitat, assuming that an effort is made to landscape them appropriately. Objective criteria include size, water features, wetland features, and vegetative cover of the BMP and its buffer.

**Other Factors.** This column indicates other considerations in BMP selection.

**Table 4.5 Community and Environmental Factors**

Code	BMP List	Maintenance Burden	Cost*	Safety Risk	Space Required	Environmental Benefits	Habitat Value	Other Factors
G-1	Extensive Green Roof	L	H	L	L	H	L	Increases structural loading on building
G-2	Intensive Green Roof	M	H				M	
R-1	Rainwater Harvesting	L	M	L	L	H	L	
D-1	Simple disconnection to a pervious area	L	L	L	M	M	L	
D-2	Simple disconnection to a conservation area							
D-3	Simple disconnection to a soil compost amended filter path							
P-1	Porous Asphalt	H	H	L	L	M	L	
P-2	Pervious Concrete							
P-3	Permeable Pavers							
B-1	Traditional bioretention	M	L		M		M	Can be used as landscaping features
B-2	Streetscape bioretention	H	H		M		M	
B-3	Expanded tree pits	M	H	L	L	H	M	
B-4	Stormwater planters	L	M		L		L	
B-5	Residential rain gardens	L	L		L		M	
F-1	Surface SF	M	L	L	M			Minimize concrete
F-2	1-Chamber Underground SF	H	M	M	L			Out of sight
F-3	3-Chamber Underground SF	H	H	M	L			Out of sight
F-4	Perimeter SF	M	M	L	M			Traffic bearing
I-1	Infiltration Trench	L	M	L	M	L	L	Avoid large stone
I-2	Infiltration Basin							Frequent pooling

H = High; M = Medium; L=Low

\* Cost based on \$ per cubic foot of stormwater treated

Code	BMP List	Maintenance Burden	Cost*	Safety Risk	Space Required	Environmental Benefits	Habitat Value	Other Factors
S-1	Underground Detention	M	H	M	L	L	L	Out of sight
S-2	Dry Pond		L		H	M		
P-1	Micropond ED Pond	M	L	M	H	M	L	Trash/debris
P-2	Wet Pond	H						
P-3	Wet ED Pond	H						
W-1	Shallow Wetland	M	M	L	H	H	H	Limit ED depth
W-2	ED Shallow Wetland							
O-1	Grass Channel	M	L	L	M	M	L	Possible mosquitoes
O-2	Dry Swale	H	M					
O-3	Wet Swale	H	M					

H = High; M = Medium; L=Low

\* Cost based on \$ per cubic foot of stormwater treated

## 4.6 Location and Permitting Considerations

In the last step, a designer assesses the physical and environmental features at the site to determine the optimal location for the selected BMP or group of BMPs (Table 4.5). The checklist below provides a condensed summary on current BMP restrictions as they relate to common site features that may be regulated under District or federal law. These restrictions fall into one of three general categories:

1. Locating a BMP within an area that is expressly *prohibited* by law.
2. Locating a BMP within an area that is *strongly discouraged*, and is only allowed on a case by case basis. District and/or federal permits shall be obtained, and the applicant will need to supply additional documentation to justify locating the BMP within the regulated area.
3. BMPs must be *set back* a fixed distance from the site feature.

This checklist is only intended as a general guide to location and permitting requirements as they relate to siting of stormwater BMPs. Consultation with the appropriate regulatory agency is the best strategy.

**Table 4.6 Location and Permitting Considerations**

Site Features and Relevant Agencies	Location and Permitting Guidance
<p><b>Jurisdictional Wetland</b></p> <p>U.S. Army Corps of Engineers Section 404 Permit</p>	<ul style="list-style-type: none"> <li>▪ Delineate wetlands prior to locating BMPs.</li> <li>▪ Use of natural wetlands for stormwater management is <i>strongly discouraged</i>.</li> <li>▪ BMPs are also <i>restricted</i> in the 25 to 100 foot required wetland buffer.</li> <li>▪ Buffers may be utilized as a non-structural filter strip (i.e., accept sheetflow).</li> <li>▪ Must justify that no practical upland treatment alternatives exist.</li> <li>▪ Stormwater must be treated prior to discharge into a wetland.</li> <li>▪ Where practical, excess stormwater flows should be conveyed away from jurisdictional wetlands.</li> </ul>
<p><b>Stream Channel</b> (Waters of the U.S.)</p> <p>U.S. Army Corps of Engineers Section 404 Permit</p>	<ul style="list-style-type: none"> <li>▪ Delineate stream channels prior to design.</li> <li>▪ In-stream ponds (should be located near the origin of first order streams) are <i>strongly discouraged</i> and require review and permit.</li> <li>▪ Must justify that no practical upland treatment alternatives exist.</li> <li>▪ Temporary runoff storage (peak flow management) is preferred over permanent pools.</li> <li>▪ Implement measures that reduce downstream warming.</li> </ul>

Site Features and Relevant Agencies	Location and Permitting Guidance
<p><b>100 Year Floodplain</b></p> <p>District of Columbia Homeland Security and Emergency Management Agency</p> <p>District Department of the Environment</p>	<ul style="list-style-type: none"> <li>▪ Grading and fill for BMP construction is <i>strongly discouraged</i> within the 100 year floodplain, as delineated by FEMA Flood Insurance Rate Maps (FIRM).</li> <li>▪ Floodplain fill may be restricted with respect to impacts on surface elevation (DCMR 20, Chapter 31 Flood Hazard Rules&gt;).</li> </ul>
<p><b>Utilities</b></p>	<ul style="list-style-type: none"> <li>▪ Locate existing utilities prior to design.</li> <li>▪ Note the location of proposed utilities to serve new construction.</li> <li>▪ Consult with each Utility on their recommended offsets</li> <li>▪ Consider altering the location or sizing of the BMP to avoid or minimize the utility conflict. Consider an alternate BMP type to avoid conflict.</li> <li>▪ Use design features to mitigate the impacts of conflicts that may arise by allowing the BMP and the utility to co-exist. The BMP design may need to incorporate impervious areas, through geotextiles or compaction, to protect utility crossings. Other a key design feature may need to be moved or added or deleted.</li> <li>▪ Coordinate with Utilities to allow them to replace or relocate their aging infrastructure during construction.</li> <li>▪ If utility functionality, longevity and vehicular access to manholes can be assured accept the BMP design and location with the existing utility. Incorporate into the BMP design sufficient soil coverage over the utility or general clearances or other features such as an impermeable linear to assure all entities the conflict is limited to maintenance.</li> <li>▪ When accepting utility conflict into BMP design, it is understood that the BMP will be temporarily impacted during utility work but the utility will replace the BMP or, alternatively, install a functionally comparable BMP according to the specifications in the current version of this Stormwater Management Guidebook. If the BMP is located in the public right-of-way the BMP restoration will also conform with the District of Columbia Department of Transportation Design and Engineering Manual with special attention to Chapter 33, Chapter 47 and the Design and Engineering Manual supplements for Low Impact Development and Green Infrastructure Standards and Specifications.</li> </ul>
<p><b>Public Right-of-Way</b></p> <p>District Department of Transportation</p>	<ul style="list-style-type: none"> <li>▪ BMP installation in PROW will require a DDOT Public Space Permit.</li> <li>▪ Consult DDOT for guidance on placement and any setback requirement from local roads.</li> </ul>



Site Features and Relevant Agencies	Location and Permitting Guidance
<p><b>Structures</b></p> <p>District Department of Transportation</p> <p>District of Columbia Water and Sewer Authority</p> <p>Department of Consumer and Regulatory Affairs</p>	<ul style="list-style-type: none"> <li>▪ Consult review authority for BMP setbacks from structures.</li> <li>▪ Recommended setbacks for each BMP group are provided in the performance criteria in <b>Error! Reference source not found.</b></li> </ul>



# Chapter 5 Administration of Stormwater Management Rules

## 5.1 Stormwater Management Plans

For all major regulated projects, projects for the generation of Stormwater Retention Credit (SRC), and submissions for the Stormwater Fee Discount, the applicant is responsible for submitting a Stormwater Management Plan (SWMP) which meets the requirements defined within the Stormwater Management and Soil Erosion and Sediment Control Regulation (District of Columbia Municipal Regulations (DCMR) Title 21, Chapter 5), and the details outlined within this guidebook. Each SWMP submitted must be signed and sealed by a registered professional engineer, licensed in the District. All SWMP applications are reviewed by DDOE to determine compliance with the requirements of 21 DCMR, Chapter 5. A series of flow charts at the end of this chapter illustrate the SWMP review and approval process, within the overall context of the permitting process.

### 5.1.1 Submittal and Review Process of Stormwater Management Plans

A SWMP contains supporting computations, drawings, and sufficient information to evaluate the environmental characteristics of the affected areas, the potential impacts of the proposed development on water resources, the effectiveness and acceptability of Best Management Practices (BMPs) and land covers for managing stormwater runoff, and maintenance and construction schedules. If the applicant proposes to use off-site retention the SWMP must indicate the number of gallons the applicant is required to retain off-site, termed Off-Site Retention Volume (Offv).

The applicant submits the SWMP, including two sets carrying the stamp of a registered professional engineer licensed in the District of Columbia with all supporting documentation, to the District of Columbia Regulatory and Consumer Affairs (DCRA). Projects may be submitted in person at the DCRA headquarters at 1100 4th Street SW, Second Floor, or through the DCRA online intake form available at <http://cpms.dcr.dc.gov/OCPI/PermitMenu.aspx>.

Some projects, for example, when the application is limited to Soil Erosion and Sediment Control Plans or Green Area Ratio, may be handled by DDOE staff located at the DCRA intake counter. All other projects will be forwarded for review to DDOE Headquarters at 1200 First Street NW, Fifth Floor. Other District agencies with review authority will also evaluate a project's SWMP. For each project the applicant has the choice of submitting the SWMP electronically or in paper form. If the SWMP is submitted in paper form, then two plan sets of the project are required.

Upon receiving an application, DDOE will determine if the application is complete and acceptable for review, accept it for review with conditions, or reject the application.

Within 10 to 30 working days of the submission date of an accepted complete application DDOE will review the SWMP, and make a determination to approve, approve with conditions, or disapprove the SWMP. Relatively large and/or complicated projects tend to require longer review time than smaller and less complicated projects.

If it is determined that more information is needed or that a significant number of changes must be made before the SWMP can be approved, the applicant may withdraw the SWMP, make the necessary changes, and re-submit the SWMP. DDOE requires that all re-submissions contain a list of the changes made. A new 10–30 day review period begins on the date of the re-submission.

If SWMP approval is denied, the reasons for the denial will be communicated to the applicant in writing.

When a SWMP approval is granted, a final submission package is required, including

- (a) One (1) Mylar copy of the SWMP, certified by a registered professional engineer licensed in the District of Columbia.
- (b) Seven (7) paper copies of the SWMP, certified by a registered professional engineer licensed in the District of Columbia.
- (c) All supporting documents specified within this SWMGor as requested during the review process by DDOE.

Note: The District of Columbia is in the process of creating a single electronic submission, review, and approval process for all DCRA building permit applicants. When DCRA migrates to the electronic submission process, this will become an alternate option for item 2 above in the final SWMP submission.

After the applicant submits a final package that meets the requirements for DDOE's approval, DDOE provides the applicant with one approved copy of the SWMP for the applicant to file at the Recorder of Deeds with the declaration of covenants and, if applicable, an easement.

Note: The applicant must submit the SWMP declaration of covenants to the Office of Attorney General (OAG) for legal sufficiency review. OAG approval is required before the SWMP can be filed with the Recorder of Deeds. Government Properties are exempt from this requirement but evidence of a maintenance partnership agreement or a maintenance memorandum of understanding is required prior to SWMP approval. There are six additional types of SWMP submissions that are not required to file declaration of covenants nor are they required to file easements. These are detailed in the exemptions Section 5.5 Exemptions.

The remaining approved paper copies of the approved SWMP are issued to the applicant after the submission of proof of filing the declaration of covenants, or evidence of a maintenance partnership agreement or a maintenance memorandum of understanding in the case of a government owned project, and each applicable easement with the Recorder of Deeds and proof of payment of applicable fee(s) for DDOE services.

Upon job completion, the applicant must certify on the approved SWMP that all activities including clearing, grading, site stabilization, the preservation or creation of non-impervious land cover, the construction of drainage conveyance systems, the construction of BMPs, and all other stormwater related components of the project were accomplished in strict accordance with the approved SWMP.

Within 21 days of the final inspection, the applicant must submit an as-built package, including one 1 Mylar copy of the as-built SWMP certified by a registered professional engineer licensed in the District of Columbia and one as-built form from Section 5.6 For a project consisting entirely of work in the public right-of-way, the submission of a Record Drawing certified by an officer of the project contracting company is acceptable if it details the as-built construction of the BMPs, related stormwater infrastructure and land covers.

The submission of a SWMP is supported by these documents:

1. Site Development Submittal Information Form
2. DC Water Storm Sewer Verification Form
3. DCRA Application for Construction Permit on Private Property
4. Environmental Intake Screening Form (EISF)
5. Environmental Questionnaire
6. DC Green Building Act Permit Application Intact Form
7. Contract Agreement
8. Lead Permit Screening Form
9. Zoning Data Summary Form
10. Reasonable Accommodations and Modifications for Persons with Disabilities Form

The forms 1 and 2 are found in Section 5.6. Supporting. Forms 3 through 10 are available at the DCRA intake counter, or they can be downloaded at <http://dcra.dc.gov/DC/DCRA/Permits/Building+Permit+Application+Supplemental+Documents>.

Note: In general, filing a Notice of Intent Form with US EPA is required if the project will disturb 1 or more acres of land, or part of a common plan of development or sale that will ultimately disturb 1 or more acres of land must file. Consult US EPA's web site for details, [http://cfpub.epa.gov/npdes/stormwater/application\\_coverage.cfm](http://cfpub.epa.gov/npdes/stormwater/application_coverage.cfm)

A Stormwater Management Plan (SWMP) includes the following:

### **Site Plan**

The following information must be submitted on a standard drawing size of 24 inches by 36 inches. The site drawing will provide details of existing and proposed conditions:

- (a) A plan showing property boundaries and the complete address of the property.
- (b) Lot number, square number or parcel number designation (if applicable).
- (c) North arrow, scale, date.
- (d) Property lines (include longitude and latitude).
- (e) Location of easements (if applicable).
- (f) Existing and proposed structures, utilities, roads and other paved areas.
- (g) Existing and proposed topographic contours.
- (h) Soil information for design purposes.
- (i) Area(s) of soil disturbance.
- (j) Volume(s) of excavation.
- (k) Volume(s) of fill.
- (l) Volume(s) of backfill.
- (m) Drainage area(s) within the limits of disturbance (LOD) and contributing to LOD.
- (n) Delineation of existing and proposed land covers including natural cover, compacted cover and impervious surfaces. Consult Appendix O for details on land cover designations.
- (o) Location of existing stream(s), wetlands, or other natural features within the project area.
- (p) All plans and profiles must be drawn at a scale of 1 in. = 10 ft, 1 in. = 20 ft, 1 in. = 30 ft, 1 in. = 40 ft, 1 in. = 50 ft, or 1 in. = 80ft Although, 1 in. = 10 ft, 1 in = 20 ft and 1 in. = 30 ft, are the most commonly used scales. Vertical scale for profiles must be 1 in. = 2 ft, 1 in. = 4 ft, 1 in. = 5 ft, or 1 in. = 10ft.
- (q) Drafting media that yield first or second generation reproducible drawings with a minimum letter size of No. 4 (1/8 inch).
- (r) Location and size of existing utility lines including gas lines, sanitary lines, telephone lines or poles, and water mains.
- (s) A legend identifying all symbols used on the plan.
- (t) Applicable flood boundaries for sites lying wholly or partially within the 100-year floodplain.
- (u) Information regarding the mitigation of any off-site impacts anticipated as a result of the proposed development.
- (v) Stormwater Pollution Prevention Plan (SWPPP<sub>CGP</sub>) (for projects disturbing over an acre) or Good House Keeping Stamp (SWPPP<sub>min</sub>), details provided in Appendix R (for sites under an acre).
- (w) Stormwater Hotspot Cover Sheet and Checklists, details provided in Appendix Q.
- (x) Integrated Pest Management Plan for sites in the AWDZ governed by the by the Anacostia Waterfront Environmental Standards Amendment Act of 2012. Consult Appendix S for details on the IPM plan submission format.

- (y) Construction specifications.
- (z) Design and “As-Built” Certification.
  - i Certification by a registered professional engineer licensed in the District that the site design, land covers, and design of the BMPs conforms to engineering principles applicable to the treatment and disposal of stormwater pollutants.
  - ii Certification and submission of the As-Built Certification by Professional Engineer form (provided in at the end of this chapter) and one set of the “As-Built” plans within 21 days after completion of construction of the site, all BMPs, land covers, covers and stormwater conveyances. For a project consisting entirely of work in the public right-of-way, the submission of a Record Drawing certified by an officer of the project contracting company is acceptable if it details the as-built construction of the BMP and related stormwater infrastructure.
- (aa) Maintenance of Best Management Practices
  - i A maintenance plan that identifies routine and long-term maintenance needs and a maintenance schedule must be submitted as part of the SWMP.
  - ii A declaration of covenants stating the owner’s specific maintenance responsibilities identified in the maintenance plan and maintenance schedule. These must be exhibits recorded with the property deed, at the Recorder of Deeds. An example of a Declaration of Covenants is provided at the end of this chapter. Government owned properties are exempt from the declaration of covenants requirement but evidence of a maintenance partnership agreement or a maintenance memorandum of understanding is required that identifies who will implement the maintenance plan and maintenance schedule.
  - iii For applicants using BMP Group 2, Rainwater Harvesting, submission of third party testing of end use water quality may be required at equipment commissioning as determined by the Tiered Risk Assessment Management (TRAM) analysis. Additional regular water quality reports certifying compliance for the life of the BMP may also be required based on the TRAM analysis.

### **Stormwater Retention Volume Computations**

- (a) Calculation(s) of required stormwater retention volume (SWR<sub>v</sub>) for entire site within the limits of disturbance (LOD) and each individual drainage area contained within the LOD.
- (b) Calculation(s) for each proposed BMP demonstrating retention value towards SWR<sub>v</sub> in accordance with Chapter 3.
- (c) For BMP Group 2, Rainwater Harvesting, calculations demonstrating the annual water balance between collection, storage and demand.

- (d) For proprietary and non-proprietary BMPs outside the Stormwater Management Guidebook, complete the submission request forms for BMP Group 12, Proprietary Practices, in Section 3.13 Proprietary Practices to receive approval or denial to use these practice(s).
- (e) Deficit SWRv gallons requiring off-site mitigation.
- (f) Statement of participation in off-site mitigation program(s), in-lieu fee or retention credit trading to manage SWRv deficit.
- (g) For projects in the existing PROW complete MEP checklists.

### **Pre/Post-Development Hydrologic Computations**

The pre/post-runoff analysis must include the following:

- (a) A summary of soil conditions and field data.
- (b) Pre/post-project curve number computation.
- (c) Time of concentration calculation.
- (d) Travel time calculation.
- (e) Peak discharge computation for each drainage area within the project's limits of disturbance for the 24-hour storms of 2-year and 15-year frequencies. All hydrologic computations must be included on the plan.

### **Hydraulic Computations**

Hydraulic computations for the final design of water quality and quantity control structures may be accomplished by hand or through the use of software using equations/formulae generally accepted in the water resources industry. The summary of collection or management systems will include the following:

- (a) Existing and proposed drainage area must be delineated on separate plans with the flow paths used for calculation of the times of concentration.
- (b) Hydraulic capacity and flow velocity for drainage conveyance, including ditch, swales, pipes, inlets, and gutter. Plan profiles for all open conveyance and pipelines, with energy and hydraulic gradients shown thereon.
- (c) The proposed development layout including the following:
  - i Location and design of BMP(s) on site.
  - ii Stormwater lines and inlets.
  - iii Location and design of BMP(s) on site.
  - iv A list of design assumptions (e.g., design basis, 15-year return period).
  - v The boundary of the contributing drainage area to the BMP.
  - vi Schedule of structures (a listing of the structures, details, or elevations including inverts



- vii Manhole to manhole listing of pipe size, pipe type, slope, computed velocity, and computed flow rate (i.e., a storm drain pipe schedule).

### **5.1.2 Resubmission of Stormwater Management Plans**

If a SWMP is accepted but changes occur in the design or construction, the applicant may be required to resubmit the SWMP for approval. Examples of changes during design and construction that may require re-submission include the following:

- A document in the original submission requires significant correction
- A document in the original submission is missing
- A document in the original submission has changed sufficiently to require replacement
- Relocation of an onsite storm sewer or conveyance
- Revision to methodology used for design of BMP(s)
- Changes to the proposed land cover
- Changes to the selection, location or sizing of BMP(s)
- Changes to the size, invert, elevation and slopes of pipes and conveyances
- Installation of new drains and conveyance structures
- Installation or relocation of the sediment trap or basin
- Revision to the approved grading and drainage divides
- Removal of contaminated soil from the site
- \* Revision to the boundaries of the floodplain
- Revision to the property boundary
- New storm sewer outlet connection to the main storm or sanitary sewer
- Modification to an approved wetland design
- Abandonment, removal or demolition of a BMP

If the applicant resubmits a SWMP after making changes, the re-submission must contain a list of the changes made. After DDOE's initial review and its review of the first resubmission, an applicant will pay the supplemental review fee for each subsequent review. Supplemental fees will not be assessed when a submission is for a project, or portion of a project, that is entirely in the existing public right of way and is following the Maximum Extent Practicable (MEP) process (see Appendix B).

## **5.2 Administration**

### **5.2.1 Approval Requirements**

A DDOE approved SWMP meeting the requirements of 21 DCMR, Chapter 5 is required before a building permit for any District project requiring stormwater management, as defined in

Chapter 2 of this guidance manual is issued by the District of Columbia Department of Consumer and Regulatory Affairs (DCRA)

### 5.2.2 Fees

An applicant is responsible for schedule fees. These fees will be collected at the times specified in Tables 5.1–5.4. These fees provide for the cost of review, administration, management of the stormwater permitting process, and inspection of all projects subject to the requirements of Chapter 5 of Title 21 of the District of Columbia Municipal Regulations Section 516 through 539.

These fees will be adjusted for inflation annually, using the Urban Consumer Price Index published by the United States Bureau of Labor Statistics.

Note: A supplemental plan review fee is required for each Department review after first resubmission of a plan. Phased review requirements that follow the Maximum Extent Practicable (MEP) process (see Appendix B) for a project, or portion of a project, entirely in the existing public right of way are not required to pay a supplemental review fee.

Note: There is no fee charged for the plan review of a SWMP submitted solely to obtain the Stormwater Fee Discount.

**Table 5.1 DCMR Chapter 5 of Title 2 501.4, Table 2. Fees for Stormwater Management Plan Review**

Plan Review Type	Payment Requirement	Fees by Land Disturbance Type	
		≥ 5,000 ft <sup>2</sup> and ≤ 10,000 ft <sup>2</sup>	> 10,000 ft <sup>2</sup>
Initial	Due upon filing for building permit	\$3,300.00	\$6,100.00
Final	Due before building permit is issued	\$1,500.00	\$2,400.00
Supplemental	Due before building permit is issued	\$1,000.00	\$2,000.00

**Table 5.2 DCMR Chapter 5 of Title 2 501.5, Table 3. Additional Fees**

Review or Inspection Type	Fees by Land Disturbance Type	
	≤ 10,000 ft <sup>2</sup>	> 10,000 ft <sup>2</sup>
Field visit for soil percolation test	\$300 for ≤ 10 borings; \$600 for > 10 borings	
Soil percolation test report review	\$150.00	
Soil characteristics inquiry	\$150.00	
Geotechnical report review	\$70.00 per hour	
After-hours inspection fee	\$50 per hour	
Stormwater pollution plan review	\$1,100.00	
Dewatering pollution reduction plan review	\$1,100.00	\$2,100.00
Application for relief from extraordinarily difficult site conditions	\$500.00	\$1,000.00

**Table 5.3 DCMR Chapter 5 of Title 2 501.6, Table 4. Fees for Review of Stormwater Management Plan to Certify Stormwater Retention Credits**

Plan Review Type	Payment Requirement	Fees by Land Disturbance Type	
		≤ 10,000 ft <sup>2</sup>	> 10,000 ft <sup>2</sup>
Initial	Due upon filing for building permit	\$575.00	\$850.00
Final	Due before building permit is issued	\$125.00	\$200.00
Supplemental	Due before building permit is issued	\$500.00	

**Table 5.4 DCMR Chapter 5 of Title 2 501.7, Table 5. Fees for Review of Green Area Ratio Plan**

Plan Review Type	Payment Requirement	Fees by Land Disturbance Type	
		≤ 10,000 ft <sup>2</sup>	> 10,000 ft <sup>2</sup>
Initial	Due upon filing for building permit	\$575.00	\$850.00
Additional	Due before building permit is issued	\$125.00	\$200.00
Supplemental	For reviews after first resubmission	\$500.00	

## 5.3 Inspection Requirements

### 5.3.1 Inspection Schedule and Reports

Prior to the approval of a SWMP, the applicant will submit a proposed construction and inspection control schedule. DDOE will review the schedule to determine if changes are required. The construction schedule should reflect the construction sequences defined in each BMP section of Chapter 3 of this guidebook. The construction and inspection schedule must be included in the SWMP. DDOE will conduct inspections at the construction stages specified in the provisions, and file reports of inspections during construction of BMPs and site stormwater conveyance systems to ensure compliance with the approved plans.

Note: No stormwater management work may proceed past the stage of construction that DDOE has identified as requiring an inspection unless,

- DDOE has issued an ~~approved~~ or ~~passed~~ report;
- DDOE has approved a plan modification that eliminates the inspection requirement; or
- DDOE has eliminated or modified the inspection requirement in writing.

DDOE may require that the professional engineer responsible for sealing the approved SWMP, the professional engineer responsible for certifying the "As-Built" SWMP, or, for a project entirely in the PROW, the officer of the contracting company responsible for certifying the Record Drawing be present during inspections.

A written notice from DDOE of an inspection finding work not in compliance with the approved SWMP requires the applicant to take prompt corrective action. The written notice provide details on the nature of corrections required and the time frame within which corrections must be made.

### 5.3.2 Inspection Requirements Before and During Construction

DDOE's construction inspection checklists for each BMP are provided in Appendix L.

**Preconstruction Meetings.** These meetings are required prior to the commencement of any land-disturbing activities and prior to the construction of any on-site or off-site BMPs.

The applicant is required to contact DDOE to schedule preconstruction meetings 3 days prior to beginning any construction activity subject to the requirements of 21 DCMR, Chapter 5.

**Inspections During Construction.** The applicant is required to contact DDOE to schedule inspection 3 days prior to any stage of BMP construction, or other construction activity, requiring an inspection. For large, complicated projects the applicant and DDOE may agree during the preconstruction meeting to an alternative approach such as a weekly notification schedule. Any such agreement must be made in writing and signed by all parties. DDOE will revert to the 3 day notification procedure if the agreement is not followed.

DDOE may require the professional engineer responsible for sealing the approved SWMP, or the professional engineer responsible for certifying the "As-Built" SWMP, or for a project entirely in the PROW, the officer of the contracting company responsible for certifying the Record Drawing be present during inspections.

**Final Inspection.** The applicant is required to contact DDOE to schedule a final inspection 1 week prior to the completion of a BMP construction to schedule a final inspection of the BMP.

A final inspection will be conducted by DDOE upon completion of the BMP to determine if the completed work is constructed in accordance with approved plans.

**Inspection Requirements by BMP Type.** Chapter 3 of this Guidance Manual provides details about the construction sequences for each BMP. After holding a preconstruction meeting, regular inspections will be made at the following specified stages of construction:

- **Infiltration Systems and Bioretention Areas.** shall be inspected at the following stages so as to ensure proper placement and allow for infiltration into the subgrade:
  - (a) During on-site/off-site percolation/infiltration test
  - (b) Upon completion of stripping, stockpiling, construction of temporary sediment control and drainage facilities
  - (c) Upon completion of excavation to subgrade
  - (d) Throughout the placement of perforated PVC/HDPE pipes (for underdrains and observation wells) including bypass pipes (where applicable), geotextile materials, gravel, or crushed stone course and backfill

- (e) Upon completion of final grading and establishment of permanent stabilization
  - **Flow Attenuation Devices**, such as open vegetated swales upon completion of construction
  - **Retention and Detention Structures**, at the following stages:
    - (a) Upon completion of excavation to sub-foundation and where required, installation of structural supports or reinforcement for structures, including but not limited to the following:
      - ◆ Core trenches for structural embankments
      - ◆ Inlet-outlet structures and anti-seep structures
      - ◆ Watertight connectors on pipes
      - ◆ Trenches for enclosed stormwater drainage facilities
    - (b) During testing of the structure watertightness
    - (c) During placement of structural fill, concrete and installation of piping and catch basins
    - (d) During backfill of foundations and trenches
    - (e) During embankment construction
    - (f) Upon completion of final grading and establishment of permanent stabilization
  - **Stormwater Filtering Systems**, at the following stages:
    - (a) Upon completion of excavation to sub-foundation and installation of structural supports or reinforcement for the structure
    - (b) During testing of the structure watertightness
    - (c) During placement of concrete and installation of piping and catch basins;
    - (d) During backfill around the structure
    - (e) During pre-fabrication of structure at manufacturing plant
    - (f) During pouring of floors, walls and top slab;
    - (g) During installation of manholes/trap doors, steps, orifices/weirs, bypass pipes, and sump pit (when applicable)
    - (h) During placement of filter bed
    - (i) Upon completion of final grading and establishment of permanent stabilization
  - **Green Roof Systems**, at the following stages:
    - (a) During placement of the waterproofing layer, to ensure that it is properly installed and watertight
    - (b) During placement of the drainage layer and drainage system
    - (c) During placement of the growing media, to confirm that it meets the specifications and is applied to the correct depth (certification for vendor or source must be provided)

- (d) Upon installation of plants, to ensure they conform to the planting plan (certification from vendor or source must be provided)
- (e) At the end of the first or second growing season, to ensure desired surface cover specified in the Care and Replacement Warranty has been achieved

### **5.3.3 Final Construction Inspection Reports**

DDOE will conduct a final inspection to determine if the completed work is constructed in accordance with approved plans and the intent of 21 DCMR, Chapter 5. A registered professional engineer licensed in the District is required to certify "As-Built" plans and state that the BMP has been constructed in accordance with the approved plans and specifications (the As-Built Certification by Professional Engineer form is provided in Appendix A. The "As-Built" certification must be on the original SWMP. Upon completion, these plans will be submitted to the DDOE for processing. The estimated time for processing will be two weeks (ten working days), after which the plans will be returned to the engineer. DDOE will provide the applicant with written notification of the final inspection results. DDOE will maintain a permanent file of inspection reports.

### **5.3.4 Inspection for Preventive Maintenance**

Preventive maintenance will be ensured through inspection of all BMPs by DDOE. The inspection will occur at least once every three years. Maintenance inspection forms are provided in Appendix M.

Preventive maintenance inspection reports will be maintained by DDOE on all BMPs. The reports will evaluate BMP functionality based on the detailed BMP requirements of Chapter 3 and inspection forms found in Appendix M.

If, after an inspection by DDOE, the condition of a BMP presents an immediate danger to the public safety or health because of an unsafe condition or improper maintenance, the DDOE will take such action as may be necessary to protect the public and make the BMP safe. Any costs incurred by DDOE will be assessed against the owner(s).

## **5.4 Maintenance**

### **5.4.1 Maintenance Responsibility**

A site with an approved SWMP must maintain the BMPs and land covers according to the maintenance schedule in the SWMP. Land covers must be maintained in type and extent as approved. Approved BMPs must be kept in good condition all the engineered and natural elements of each practice, as well as conveyance features (e.g., grade surfaces, walls, drains, structures, vegetation, erosion and sediment control measures, and other protective devices). All repairs or restorations must be in accordance with the approved SWMP.

A declaration of covenants including an exhibit stating the owner's specific maintenance responsibilities must be recorded with the property deed, at the Record of Deeds. A maintenance schedule for any BMP will be developed for the life of the project and shall state the maintenance to be completed, the time for completion, and who will perform the maintenance

including provisions for normal and abnormal maintenance. The maintenance schedule will be printed on the SWMP and will appear as an exhibit in the declaration of covenants.

#### **5.4.2 Maintenance Agreement**

DDOE will not issue final approval of a complete set of the SWMP for private parcels until the applicant has executed a declaration of covenants binding current and subsequent owners of the land served by the BMP(s) and land covers to an inspection and maintenance agreement. Such agreement shall provide for access to the site and the BMP(s) at reasonable times, and for regular inspection by DDOE, and for regular or special assessments of property owners, as needed, to ensure that the BMP(s) is maintained in proper working condition and the land covers are retained as approved in the SWMP. An example of the declaration of covenants for a site with BMPs and designated land covers is provided at the end of this chapter.

The agreement must be recorded as a declaration of covenants with the Recorder of Deeds of the District by the applicant. The agreement must also provide that, if after written notice by DDOE to correct a violation requiring maintenance work, satisfactory corrections are not made by the owner(s) of the land served by the BMP within a reasonable period of time, not to exceed 45-60 days unless extended for good cause shown, DDOE may perform all necessary work to place the BMP in proper working condition. The owner(s) of property served by the BMP will be assessed the cost of the work and any penalties and there will be a lien on any property served by the BMP, which may be placed on the tax bill and collected as ordinary taxes by the District.

### **5.5 Exemptions**

If a major substantial improvement activity demonstrates that it is not part of a common plan of development with a major land-disturbing activity, then it is exempt from the 2-year and 15-year storm-control requirements.

If DDOE determines that a land-disturbing activity is conducted solely to install a BMP or land cover for any of the following six reasons:

1. To generate a Stormwater Retention Credit,
2. To earn a stormwater fee discount under the provisions of this chapter,
3. To provide for off-site retention through in-lieu fee payments,
4. To comply with a Watershed Implementation Plan established under a Total Maximum Daily Load for the Chesapeake Bay,
5. To reduce Combined Sewer Overflows (CSOs) in compliance with a court-approved consent decree, including court-approved modifications, for reducing CSOs in the District of Columbia, or in compliance with a National Pollutant Discharge Elimination System permit, or
6. For a utility project that is being conducted solely to protect or restore surface water quality, including projects for improving wastewater treatment and reducing CSOs,

then these SWMPs are exempt from stormwater performance requirements for major land disturbing activities and stormwater performance requirements for major substantial

improvements activities, as well as requirements for covenants and easements. The stormwater obligations for these sites generating SRCs are detailed in Chapter 7 of this guidance manual.

Note: While the declaration of covenants and easements are not required with these projects, an executed maintenance contract or a signed promise to follow the Department-approved maintenance plan for the period of time for which the certification of SRCs is requested is required for SWMP approval. If the site fails to maintain these retention practices DDOE has recourse that is spelled out in Chapter 5 and Chapter 7 of this guidance manual.

Land-disturbing activities that consist solely of cutting a trench for utility work and related replacement of sidewalks and ramps are exempt from stormwater management requirements if the activity does not involve the reconstruction of a roadway from curb to curb or curb to centerline of roadway.

Land-disturbing activities conducted solely to respond to an emergency need to protect life, limb, or property or to conduct emergency repairs are exempt from most stormwater management requirements. These activities are not required to submit a SWMP, but they are subject to inspections to ensure the proper use of soil erosion and sediment control measures.

## **5.6 Supporting Forms**

1. Site Development Submittal Information Form
2. DC Water Storm Sewer Verification Form
3. As-Built Certification Stamp
4. Declaration of Covenants



Watershed Protection Division  
 Site Development Submittal Information

---

**Section 1. To be completed by the applicant:** Date: \_\_\_\_\_

**Property Location:** \_\_\_\_\_ Latitude \_\_\_\_ ( ) Longitude \_\_\_\_ ( )

Development Review Type: \_\_\_\_\_ Proposed Construction Date: \_\_\_\_\_

Lot # \_\_\_\_\_ Square# \_\_\_\_\_ Parcel # \_\_\_\_\_ Zoning Approved:  Yes  No

Subdivision:  Yes  No Restrictive Covenant:  Yes  No

**Type / Description of work:**  Single Family,  Duplex,  Townhouses,  Condominium,  Office Building

Apartment Building  Industrial Building  Parking Lot  Foreign Govt. Office / Residence

Federal land/property (specify) \_\_\_\_\_  District land/property (specify) \_\_\_\_\_ Other \_\_\_\_\_

**Property Owner:**

Name: \_\_\_\_\_ Phone#: ( ) \_\_\_\_\_ Fax #: ( ) \_\_\_\_\_

Firm (if applicable): \_\_\_\_\_

**Applicant :**

Name (First): \_\_\_\_\_ (Last): \_\_\_\_\_ Phone#: ( ) \_\_\_\_\_

Fax #: ( ) \_\_\_\_\_ E-Mail (if applicable) \_\_\_\_\_

Street Address: \_\_\_\_\_ City \_\_\_\_\_ State \_\_\_\_\_ Zip \_\_\_\_\_

**Designer**  **Engineer**  **Architect:** (Check one or more)

Firm: \_\_\_\_\_ Phone#: ( ) \_\_\_\_\_ Fax #: ( ) \_\_\_\_\_

Street Address: \_\_\_\_\_ City \_\_\_\_\_ State \_\_\_\_\_ Zip \_\_\_\_\_

Contact Person: \_\_\_\_\_ E-Mail \_\_\_\_\_

*My signature attests that the attached application package is complete and accurate to the best of my knowledge. I understand that proper review of this plan depends upon the accuracy of the information, and that inaccurate information submitted by me, my firm, or agent may delay this project.*

Signature: \_\_\_\_\_ Date: \_\_\_\_\_

---

**Section 2. To be completed by WPD staff.**

Assigned EHA/WPDCase#: \_\_\_\_\_ Assigned DCRA Intake/Case# \_\_\_\_\_

Plan Received by: \_\_\_\_\_ Date Submitted: \_\_\_\_\_ Plan Recieved By: \_\_\_\_\_

Plan Assigned To (Engr.) \_\_\_\_\_ Date Assigned: \_\_\_\_\_

**GOVERNMENT OF THE DISTRICT OF COLUMBIA  
DISTRICT DEPARTMENT OF THE ENVIRONMENT**

**Application for Discharge from New Stormwater Management BMP**

1. *Proposed Discharge from Stormwater Best Management Practice (BMP) By Applicant:*

- A. BMP Type: \_\_\_\_\_
- B. Project Location: \_\_\_\_\_  
 \_\_\_\_\_ Square: \_\_\_\_\_ Lot: \_\_\_\_\_
- C. Post-development Peak Flows:  
 15-Year \_\_\_\_\_ cfs;       2-Year \_\_\_\_\_ cfs.
- D. Receiving System Type, Location, Slope, and Depth:  
 Combined Sewer       Separate Sewer  
 Depth: 5ft    Yes    No       Specify: \_\_\_\_\_  
 Slope: 2%    Yes    No       Specify: \_\_\_\_\_  
 Groundwater      Depth: \_\_\_\_\_ ft.  
 Surface Water Ways: \_\_\_\_\_  
 Discharge Location Or Name Of The Surface Waterways: \_\_\_\_\_

E. The proposed Invert Connection Elevation: \_\_\_\_\_ ft.

2. *Hydraulic Sewer System Verification By DCWater:*

- A. Combined Sewer Area    Yes    No.      B. Separate Sewer Area:    Yes    No  
 C. The Sewer System Is Within \_\_\_\_\_ ft.  
 D. Maximum Depth 5 ft.    Yes    No      E. Slope  $\geq$ 2%    Yes    No    \_\_\_\_\_

3. *Surface Water & Groundwater Ways Verification By Watershed Protection Division:*

- A. Surface Water Ways:  
 Max. Flow Allowed: \_\_\_\_\_ cfs    Max. Velocity Allowed: \_\_\_\_\_ ft/sec
- B. Groundwater:  
 Minimum Infiltration Allowed: \_\_\_\_\_ ft/hr

Requested By: \_\_\_\_\_       Agent       Owner  
 Address : \_\_\_\_\_  
 Tel: ( ) \_\_\_\_\_      Fax: ( ) \_\_\_\_\_      Date Requested: \_\_\_\_\_

DC Water Verification: By: (Name) \_\_\_\_\_, Title \_\_\_\_\_  
 Tel: ( ) \_\_\_\_\_      Fax: ( ) \_\_\_\_\_      Date Verified: \_\_\_\_\_

DDOE WPD Verification By: (Name) \_\_\_\_\_, Title \_\_\_\_\_  
 Tel: ( ) \_\_\_\_\_      Fax: ( ) \_\_\_\_\_      Date Verified: \_\_\_\_\_

Notes: \_\_\_\_\_

**AS-BUILT CERTIFICATION BY PROFESSIONAL ENGINEER**

Within 21 days after completion of construction of the Stormwater discharge facility, please send this page to the Watershed Protection Division of the District Department of the Environment.

1. **Stormwater discharge facility information:**

Source Name: \_\_\_\_\_

Source Location: Street: \_\_\_\_\_

City: \_\_\_\_\_

DCRA Permit No.: \_\_\_\_\_

Date Issued: \_\_\_\_\_

2. **As Built Certification**

I hereby certify that Stormwater discharge facility has been built substantially in accordance with the approved plans and specifications, and that any substantial deviations (noted below) will not prevent the system from functioning in compliance with the requirements of Section 526 through 535 of DCMR-21, Chapter 5 when properly maintained and operated. These determinations have been based upon on-site observation of construction, scheduled and conducted by me or by a project representative under my direct supervision. I have enclosed one set of as-built engineering drawings.

\_\_\_\_\_  
Signature of Engineer

\_\_\_\_\_  
Name (Please Type) D.C. Reg. No.

Affix Seal:

\_\_\_\_\_  
Company Name

\_\_\_\_\_  
Company Address

Date: \_\_\_\_\_ Phone No. \_\_\_\_\_

Substantial deviations from the approved plans and specifications (attach additional sheets if required).

\_\_\_\_\_  
\_\_\_\_\_  
\_\_\_\_\_  
\_\_\_\_\_

**THE GOVERNMENT OF THE DISTRICT OF COLUMBIA**

**District Department of the Environment  
NATURAL RESOURCES ADMINISTRATION  
WATERSHED PROTECTION DIVISION**

**DECLARATION OF COVENANTS**

**For a Stormwater Management Facility**

THIS DECLARATION OF COVENANTS (the **–Declaration–**) is made as of this \_\_\_\_\_ day of \_\_\_\_\_, 20\_\_\_\_, by and between **LIST NAME OF OWNER, a LIST TYPE OF CORPORATION/PROPERTY OWNER**, and its successors and assigns (**–Owner–**), for the benefit of the DISTRICT OF COLUMBIA, a municipal corporation (the **–District–**).

**RECITALS**

A. The Owner is the owner in fee simple of certain real property and improvements (collectively, the **–Property–**) located in the District of Columbia and more particularly described in **Exhibit A** attached hereto and made a part hereof. No other person or entity has an ownership interest in the Property.

B. In order to accommodate and regulate changes in stormwater flow conditions resulting from certain improvements Owner will make to the property, Owner shall construct and agrees to maintain, at its sole expense, a stormwater management facility and sustainable design features (collectively, the **–Facility–**) identified as \_\_\_\_\_, pursuant to the plans approved by the District (and as the same may be amended after District’s approval) attached hereto as **Exhibit B** as the Site Plan.

C. Title 21 of the District of Columbia Municipal Regulations (**–DCMR–**) Sections 534.2, 534.3, and 534.4 require that an owner maintain any stormwater management facility on its property in good condition, develop and submit for approval a maintenance schedule for any such stormwater management facility, and execute and record with the Recorder of Deeds of the District a covenant setting forth the owner’s aforementioned maintenance responsibilities with specificity.

NOW, THEREFORE, for and in consideration of the issuance of construction permits and approval of Owner's plans by the District, and other good and valuable consideration the sufficiency of which is hereby acknowledged, for the benefit of and limitation upon Owner and all future owners of the Property, and for the benefit of the District, Owner for itself, its successors and assigns, does hereby acknowledge, represent, covenant, agree, and warrant to the District as follows:

1. The foregoing Recitals and attached Exhibits are all hereby incorporated in and made a part of this Declaration to the same extent as if herein set forth in full, provided however, that said Recitals shall not be deemed to modify the express provisions hereinafter set forth.

2. Owner shall construct and perpetually operate and maintain the Facility in such manner as to comply with the provisions of Title 21, Chapter 5 of DCMR at its sole expense and in strict accordance with the development and maintenance plan approved by the District. Specifically, Owner shall be responsible for the maintenance of the Facility in accordance with the maintenance standards attached hereto as **Exhibit C**.

3. Owner shall, at its sole expense, make such changes or modifications to the Facility as may, in the District's discretion, be determined necessary to insure that the Facility is maintained in good condition and continues to operate as designed and approved.

4. The District and its agents, employees and contractors shall have the right to enter the Property for the purpose of inspecting the Facility in accordance with established inspection procedures and Section 16 of the Water Pollution Control Act of 1984 (D.C. Law 5-188; 32 DCR 919; D.C. Official Code §8-103.01, *et seq.* (2007 Supp.), and as amended, (the "Act"), at reasonable times and in a reasonable manner, in order to insure that the Facility is being properly maintained and is continuing to perform in the manner approved by the District.

5. Should Owner fail to perform its maintenance responsibilities as set forth herein and as contained in any and all plans submitted to and approved by the District, or fail to operate and, where necessary, restore the Facility in accordance with the approved design standards, as the same may be amended from time to time, and in accordance with all applicable laws and regulations, the District shall be entitled to pursue any and all enforcement actions available to it pursuant to the Act and Title 21, Chapter 22 of the DCMR, as the same may be amended or revised from time to time. Without limiting the generality of the foregoing, in the event that a discharge or threat of discharge from the Facility poses an imminent and substantial danger to the public health or welfare, the District may take immediate action against Owner pursuant to either Section 21-2207 or Section 21-2211.2 of the DCMR.

6. If Owner's failure or refusal to maintain the Facility in accordance with the covenants and warranties contained in this Declaration ultimately results in duly authorized corrective action by the District, Owner shall bear all costs incurred by the District for such corrective measures, such costs may be assessed against the Property, and Owner may be fined in accordance with the Act and Title 21, Chapter 5 of the DCMR.

7. The provisions of this Declaration shall be deemed warranties by the Owner and covenants running with the land and shall bind and inure to the benefit of Owner and the District, their respective heirs, successors and/or assigns. When Owner ceases to own an interest in the Property, the rights, warranties, and obligations under this Declaration shall become the rights, warranties, and obligations of the successor-in-ownership and interest as to the Property.

8. Owner shall, at its cost and expense, properly record this Declaration with the Recorder of Deeds and furnish the District's Department of the Environment and Office of the Attorney General with a copy of this Declaration, certified by the Recorder of Deeds as a true copy of the recorded instrument.

9. Owner shall indemnify, save harmless, and defend the District, and all its officers, agents, and employees from and against all claims or liabilities that may arise out of or in

connection with, either directly or indirectly, any of Owner's actions or omissions with regard to the construction, operation, maintenance and/or restoration of the Facility.

10. Owner shall insure that all prior liens recorded against the Property are subordinate to this Declaration. Failure to subordinate any such liens may give rise to termination of any building permits and/or invalidation of any certificate of occupancy relating to the Property.

11. Owner shall, at its sole expense, comply with all provisions of this Declaration regardless of any conflicting requirements in any other covenant, easement, or other legal document recorded or unrecorded against the Property. Neither the entering into of this Declaration nor performance hereunder will constitute or result in a violation or breach by Owner of any other agreement or order which is binding on the Owner.

12. To the extent the Owner is an entity, the Owner warrants that it is (i) duly organized, validly existing and in good standing under the laws of its state of jurisdiction and is qualified to do business and is in good standing under the laws of the District of Columbia, (ii) is authorized to perform under this Declaration and (iii) has all necessary power to execute and deliver this Declaration.

13. The form of this Declaration has been approved by the District of Columbia Office of the Attorney General for legal sufficiency pursuant to Title 12A, Section 106.6 of the D.C.M.R. This Declaration, and the provisions contained herein, may not be modified, amended, or terminated without the prior written consent of the District and legal sufficiency approval by the District of Columbia Office of the Attorney General, such agreement to be evidenced by a document duly executed and delivered in recordable form and recorded with the Recorder of Deeds at no expense to the District.

14. The District has the right to specifically enforce this Declaration.

15. This Declaration shall be governed by, construed and enforced in accordance with, the laws of the District of Columbia.

16. This Declaration has been duly executed and delivered by the Owner, and constitutes the legal, valid, and binding obligations of the Owner, enforceable against the Owner and its successors and assigns, in accordance with its terms.

17. If any of the covenants, warranties, conditions or terms of this Declaration shall be found void or unenforceable for whatever reason by any court of law or of equity, then every other covenant, condition or term herein set forth shall remain valid and binding.

**[SIGNATURES FOLLOW]**

IN WITNESS WHEREOF, Owner has, as of the day and year first above written, caused this Declaration of Covenants to be signed by **LIST NAME OF OWNER, a LIST TYPE OF CORPORATION/PROPERTY OWNER.**

By: \_\_\_\_\_  
Signature  
**LIST NAME**  
**LIST TYPE OF COMPANTY/PROPERTY OWNER**

**NOTARIZATION**

\_\_\_\_\_**LIST STATE**\_\_\_\_\_) )  
\_\_\_\_\_) ss:  
\_\_\_\_\_**LIST COUNTY**\_\_\_\_\_ )

I, **LIST NAME OF NOTARY**, a Notary Public in and for the jurisdiction aforesaid, do hereby certify that **LIST NAME OF PERSON SIGNING ON BEHALF OF OWNER**, party to the foregoing Declaration of Covenants, personally appeared before me and, being personally well known to me, who has been appointed its attorney-in-fact and has acknowledged said Declaration of Covenants to be the act and deed of **LIST NAME OF OWNER/LIST NAME OF COMPANY IN CAPACITY AS OWNER/PROPERTY OWNER**, and that s/he delivered the same as such.

GIVEN under my hand and seal this \_\_\_\_ day of \_\_\_\_\_, 2009.

\_\_\_\_\_  
Notary Public

My commission expires:

**[NOTARIAL SEAL]**



**APPROVED AS TO TECHNICAL SUFFICIENCY:**

District of Columbia

District Department of the Environment

Natural Resources Administration

Watershed Protection Division

By: \_\_\_\_\_

Name: \_\_\_\_\_

Title: \_\_\_\_\_

Date: \_\_\_\_\_

**APPROVED AS TO LEGAL SUFFICIENCY:**

District of Columbia Office of the Attorney General

Real Estate Section

By: \_\_\_\_\_

Assistant Attorney General

Date: \_\_\_\_\_

**EXHIBIT A**

[LEGAL DESCRIPTION ]

**EXHIBIT B**

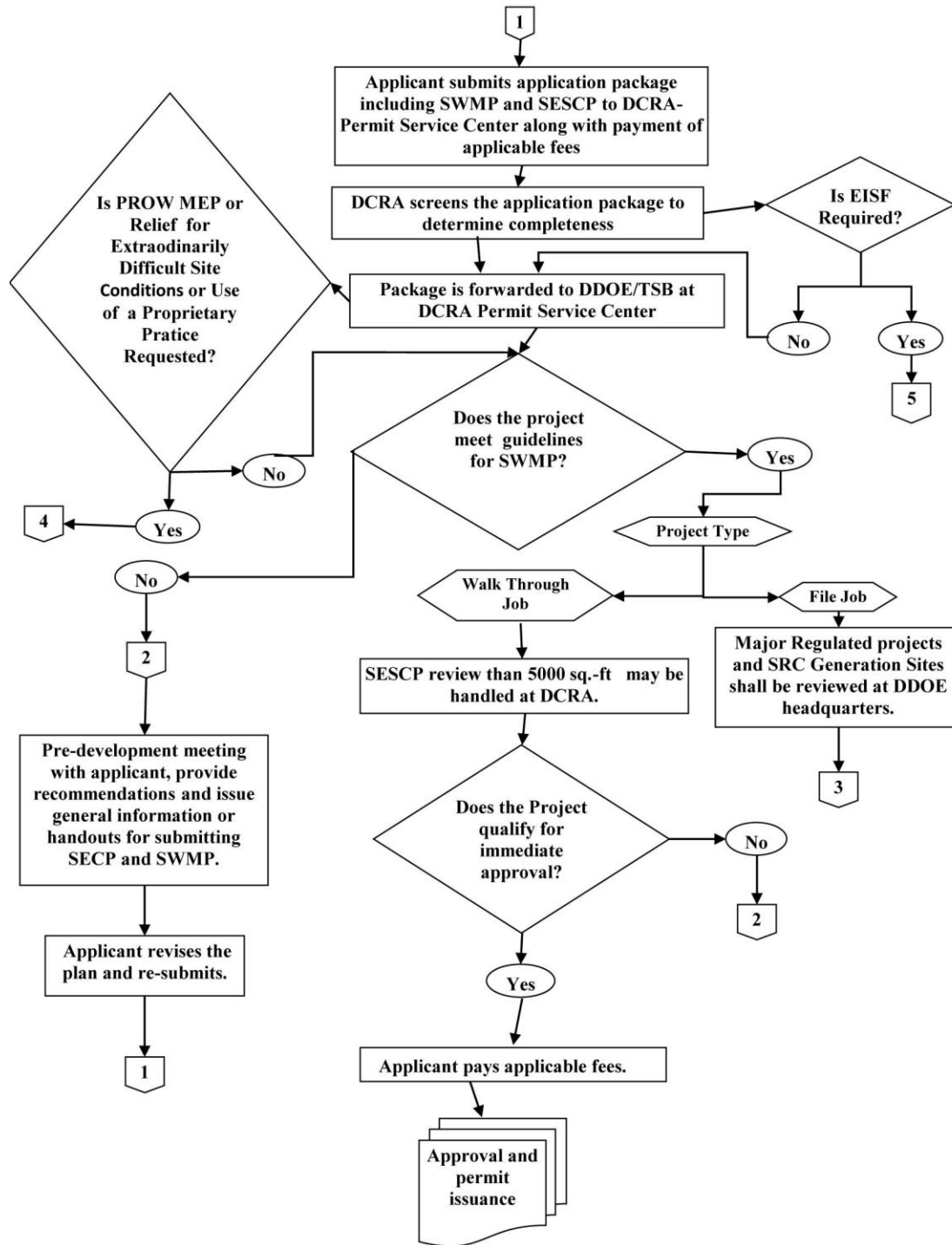
[SITE PLAN]

**EXHIBIT C**

[MAINTENANCE SCHEDULE]

## **5.7 Flow Diagram of Plan Review Process**

Flow charts, in Figures 5.1 through 5.4 illustrate the five steps in DDOE's review of a Stormwater Management Plan (SWMP) and Soil Erosion and Sediment Control Plan in the context of the overall permitting process, which includes the Environmental Impact Statement Form (EISF) process.



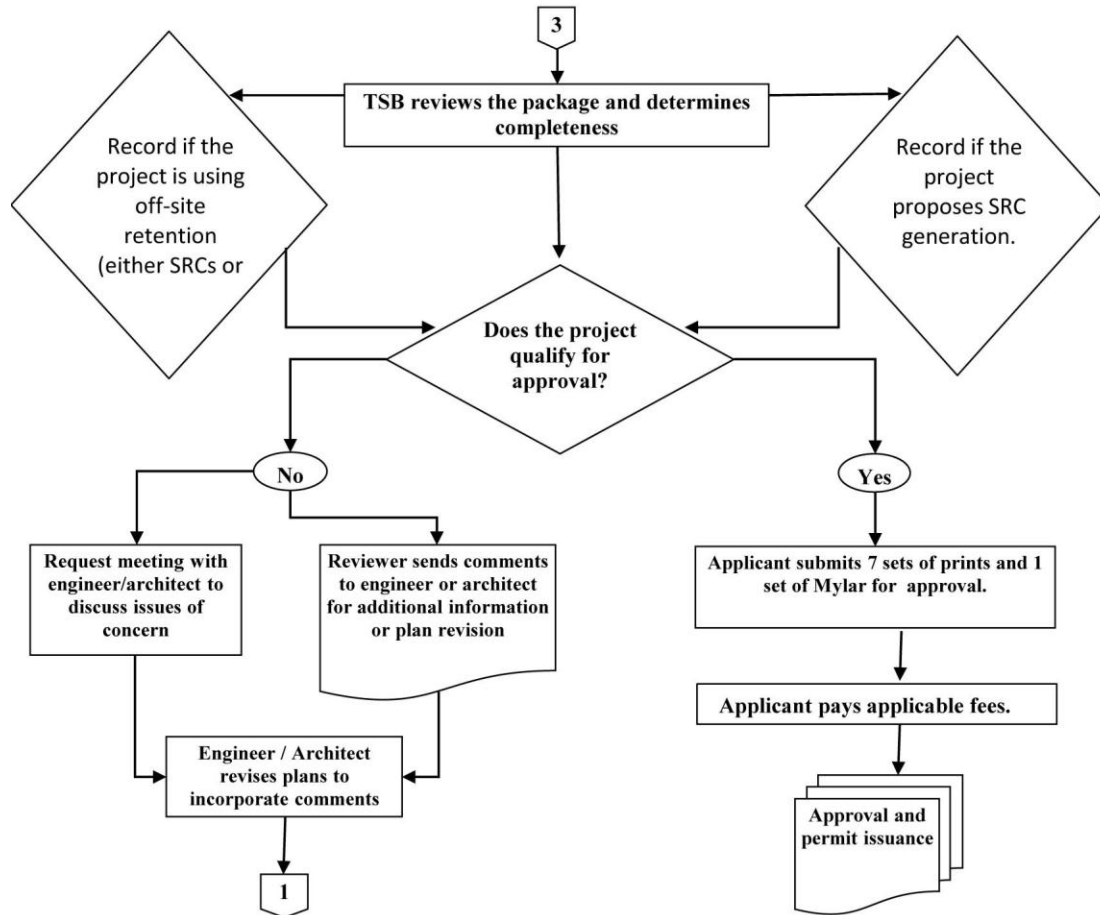
Note:

SESCO : Soil Erosion and Sediment Control Plan  
 SWMP : Storm Water Management Plan  
 ERC : Environmental Review Coordinator  
 PROW: Public Right of Way  
 SRC: Stormwater Retention Credit

DCRA: Department of Consumer and Regulatory Affairs  
 EISF: Environmental Impact Screening Form  
 TSB: Technical Services Branch  
 MEP: Maximum Exent Practicable

Revision Date: 08/15/2012

Figure 5.1 Stormwater Management and Soil Erosion and Sediment Control Plan Review, Steps 1 and 2.



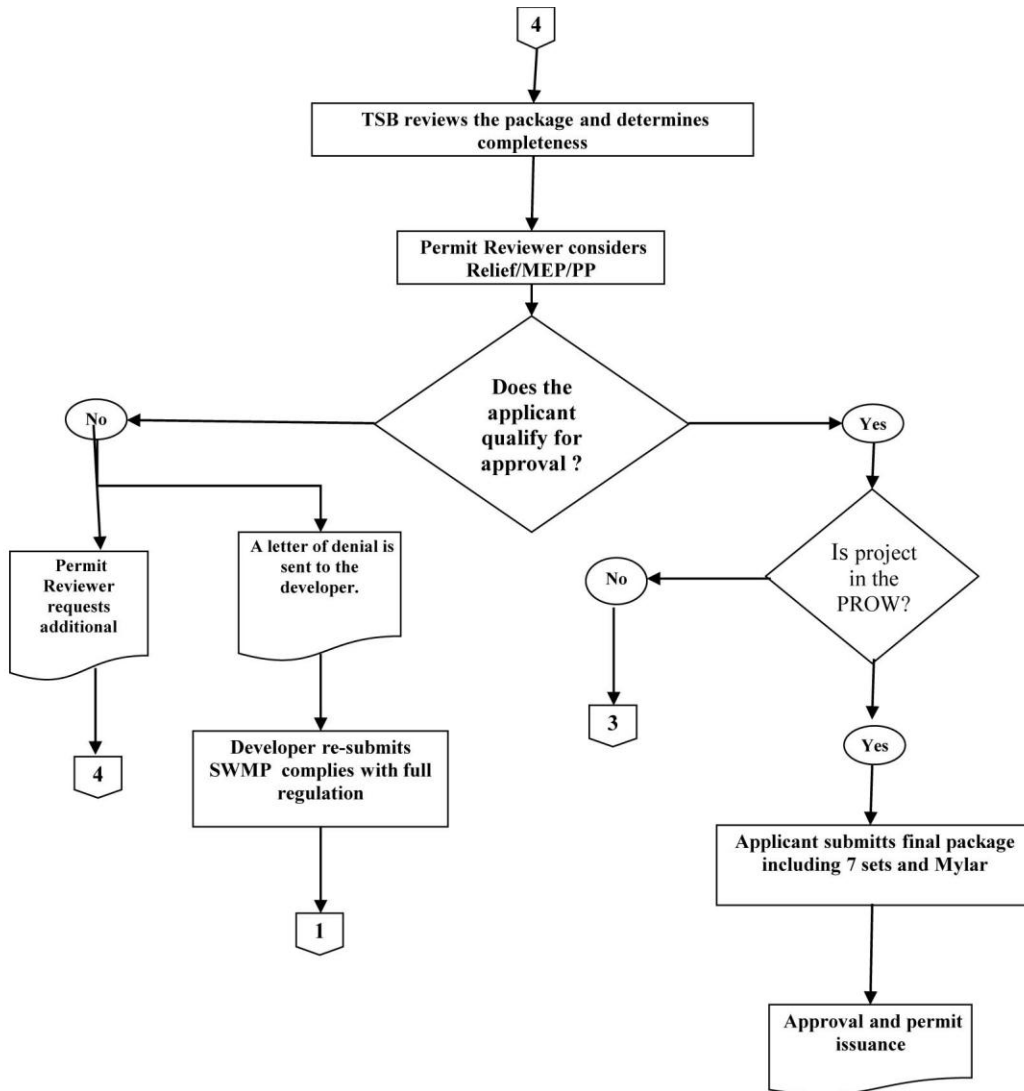
Note:

**SESCP** : Soil Erosion and Sediment Control Plan  
**SWMP** : Storm Water Management Plan  
**ERC** : Environmental Review Coordinator  
**PROW**: Public Right of Way  
**SRC**: Stormwater Retention Credit

**DCRA**: Department of Consumer and Regulatory Affairs  
**EISF**: Environmental Impact Screening Form  
**TSB**: Technical Services Branch  
**MEP**: Maximum Exent Practicable

Revision Date: 08/15/2012

Figure 5.2 Stormwater Management and Soil Erosion and Sediment Control Plan Review, Step 3.



Note:

**SESCP** : Soil Erosion and Sediment Control Plan

**SWMP** : Storm Water Management Plan

**ERC** : Environmental Review Coordinator

**PROW**: Public Right of Way

**Relief**: Relief for Extraordinarily Difficult Site Conditions

**PP**: Proprietary Practice

**SRC**: Stormwater Retention Credit

**DCRA**: Department of Consumer and Regulatory Affairs

**EISF**: Environmental Impact Screening Form

**TSB**: Technical Services Branch

**MEP**: Maximum Exent Practicable

Revision Date: 08/15/2012

**Figure 5.3 Stormwater Management and Soil Erosion and Sediment Control Plan Review, Step 4.**



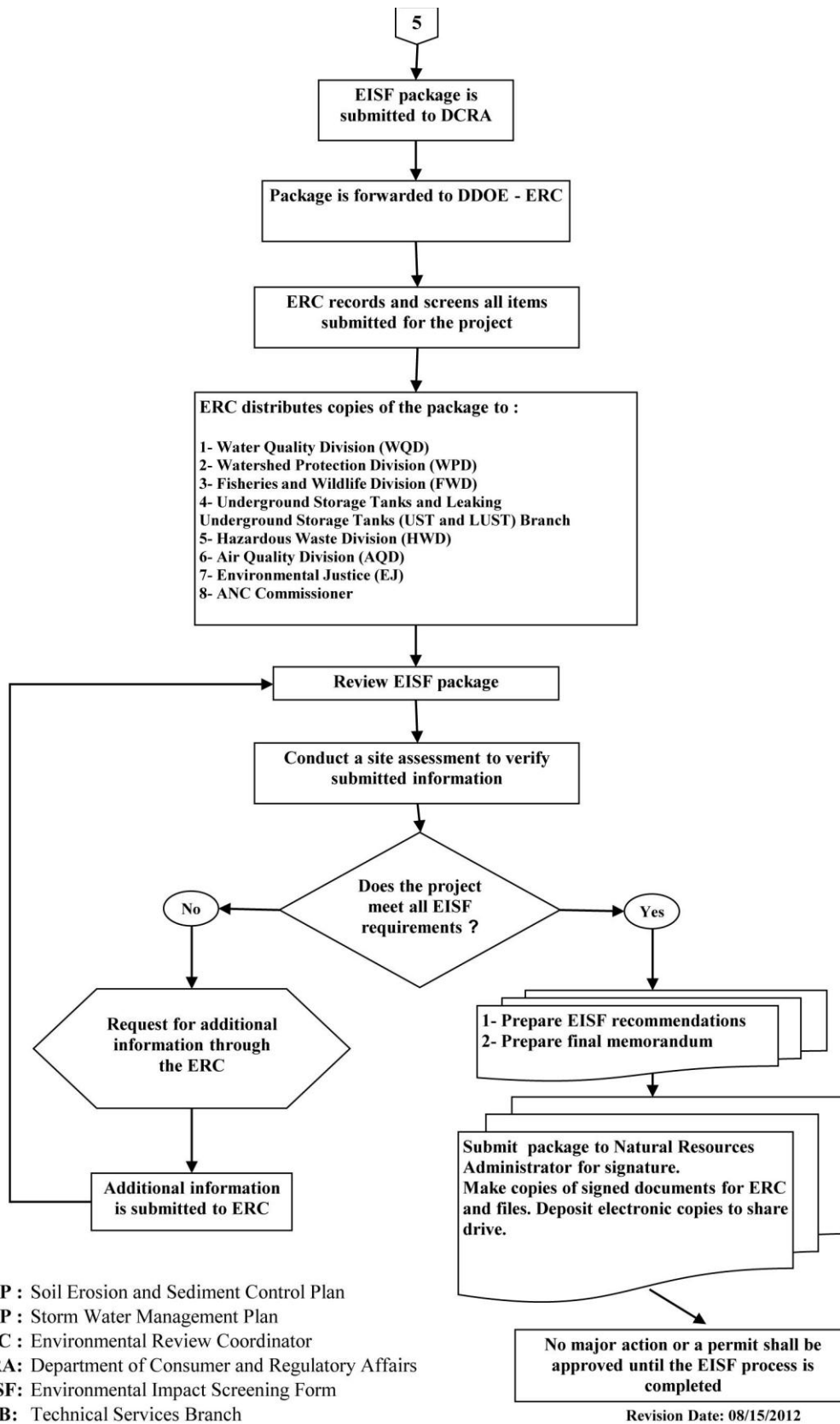


Figure 5.4 Stormwater Management and Soil Erosion and Sediment Control Plan Review, Step 5.



# Chapter 6                      Use of Off-site Retention by Regulated Sites

## 6.1 Off-Site Retention Overview

A regulated site must retain a minimum volume on-site that is equal to 50 percent of the SWRv. Above that minimum on-site volume, the regulated site may use off-site retention without having to first demonstrate that it would be infeasible to retain that volume on site. However, in order to retain less than the minimum on-site volume, the site must demonstrate that on-site retention of that volume is technically infeasible or environmentally harmful.

The portion of a SWRv that a regulated site does not retain on-site is termed the Off-Site Retention Volume or Offv, and a regulated site's options for achieving its Offv are the following:

- (a) Use Stormwater Retention Credits (SRCs), each of which corresponds to one gallon of retention for one year; or
- (b) Pay DDOE's in-lieu fee (ILF), the cost of which corresponds to one gallon of retention for one year; or
- (c) A combination of A and B.

The owner of a regulated site may use SRCs that the owner has earned elsewhere in the District or SRCs purchased on the private market. DDOE will provide the regulated site with contact information for SRC owners who wish to sell their SRCs. SRC buyers and sellers negotiate the terms of a transaction between themselves, but the transaction is not complete until DDOE has approved it. DDOE's approval is required so that DDOE can effectively track ownership and use, including preventing fraudulent use of SRCs, and also publicly share the price at which SRCs sell.

Regulated sites are responsible for their Offv on an ongoing basis, just as they must maintain any on-site stormwater Best Management Practices (BMPs) on an ongoing basis. In other words, they must continue to use SRCs or pay in-lieu fee for the life of the development, similar to paying a lease or utility fee. However, if in the future a regulated site retrofits and achieves its Offv on site, then it no longer must achieve that volume off site.

A regulated site may meet its Offv for multiple years by paying up front for sufficient in-lieu fee to satisfy its Offv for that time period. Likewise, the regulated site may purchase and commit to use sufficient SRCs to satisfy its Offv for multiple years. SRCs may be banked indefinitely. The one year lifespan of an SRC or in-lieu fee payment begins once it is used to satisfy an Offv.

Once SRCs have been used or sold, they remain valid, even if the owner of the retention practices for which SRCs were certified fails to maintain them. Note, however, that there are consequences for original SRC owners that fail to maintain retention practices for which SRCs have been certified, as discussed in Chapter 7 and Appendix D.

Each SRC will have a unique serial number, and DDOE will track how a regulated site is satisfying its Offv. DDOE will automatically assess an in-lieu fee, with penalties for late payment, for any site that does not stay current with its Offv obligation. DDOE may also take other action, including enforcement action, against a regulated site for failure to comply with an Offv.

The Stormwater Management Plan (SWMP) for a regulated site opting to use off-site retention must state its Offv. This Offv, along with related requirements for sites in the Anacostia Waterfront Development Zone, will be recorded in the declaration of covenants filed for the property. Whether using in-lieu fee or SRC, they must be in use as of the successful completion of DDOE's final inspection at the end of the construction process.

## **6.2 Off-Site Retention via Stormwater Retention Credits**

One SRC satisfies one gallon of Off-Site Retention Volume (Offv) for one year. The use of an SRC is not restricted by watershed. However, for every gallon of Offv that an Anacostia Waterfront Development Zone (AWDZ) site elects to meet with SRCs from outside the Anacostia River watershed, it must use 1.25 SRCs.

A regulated site with an Offv may elect at a future date to install additional stormwater Best Management Practices (BMPs) on-site in a sufficient volume to eliminate or reduce the Offv.

To use SRCs to meet an Offv, a regulated site owner must submit an application to use SRCs to meet its Offv (see Appendix C). The application must identify SRCs that are owned by the site owner and may cover multiple years of Offv. The application must be submitted 30 days in advance of the planned date of use. SRCs (and/or in-lieu fee) must be in use as of the successful completion of DDOE's final inspection at the end of the construction process and thereafter on an ongoing basis.

After verifying the ownership of the SRCs and other information in the application to use SRCs, DDOE will approve the use of the SRCs. DDOE will not sign off on a regulated site's final inspection at the end of the construction process until it has approved the application and verified that any Offv is achieved. The one-year lifespan of the SRCs begins as of the date that it is used to meet the Offv.

At least 30 days before SRCs used to satisfy an Offv are set to expire, the regulated site owner must submit an application identifying additional SRCs that will be used to satisfy the Offv or pay in-lieu fee.

If DDOE does not receive an application to use SRCs or an in-lieu fee payment and a lapse in compliance with an Offv occurs, DDOE shall charge an in-lieu fee, with a 10 percent late fee, to the regulated site owner and provide notice to the site owner accordingly. For a site owner who does not comply within 30 days of DDOE's notice of a lapse in satisfaction of an Offv obligation and who owns an SRC that has not been used to satisfy the Offv for another site, DDOE may apply that SRC to the Offv that is out of compliance. DDOE may also take enforcement action against a regulated site that fails to comply with an Offv.

### **Summary of Key Steps for Using SRCs**

- Step 1:** Apply to use SRCs to satisfy Offv 30 days in advance of final construction inspection.
- Step 2:** Receive DDOE approval of use of SRCs.
- Step 3:** Schedule final construction inspection with DDOE (step 2 and 3 can be reversed)
- Step 4:** Pass final construction inspection and start use of SRCs.
- Step 5:** 30 days before SRC expiration, apply to use additional SRCs to satisfy Offv.
- Step 6:** Receive DDOE approval of use of SRCs.
- Step 7:** Repeat steps 5 and 6 as necessary.

### **6.3 Off-Site Retention via In-Lieu Fee**

In-lieu fee corresponds to one gallon of retention for one year. Payment of one gallon worth of in-lieu fee satisfies one gallon of Off-Site Retention Volume (Offv) for one year. A regulated site may elect to install additional BMPs on-site in a sufficient volume to eliminate or reduce the Offv.

To use in-lieu fee to meet an Offv, a regulated site must submit payment to the District, along with a notification form (see Appendix C). The notification and payment may be for multiple years. The notification and payment must be submitted 30 days in advance of the planned date of use. In-lieu fee (and/or SRCs) must be in use as of the successful completion of DDOE's final inspection at the end of the construction process and thereafter on an ongoing basis.

DDOE will confirm receipt of in-lieu fee. DDOE will not sign off on a regulated site's final inspection at the end of the construction process until it has verified that its Offv is achieved. The one-year lifespan of the in-lieu fee begins as of the date that it is used to meet Offv.

If DDOE does not receive an application to use SRCs or an in-lieu fee payment and a lapse in compliance with an Offv occurs, DDOE shall charge an in-lieu fee, with a 10 percent late fee, to the regulated site owner and provide notice to the site owner accordingly. For a site owner who does not comply within 30 days of DDOE's notice of a lapse in satisfaction of an Offv obligation and who owns an SRC that has not been used to satisfy the Offv for another site, DDOE may apply that SRC to the Offv that is out of compliance. DDOE may also take enforcement action against a regulated site that fails to comply with an Offv.

### **6.4 Forms for Use of Off-site Retention**

- Application to Use Stormwater Retention Credits for Off-Site Retention Volume
- Notification of In-Lieu Fee Payment



# Chapter 7                      **Generation, Certification, Trading, and Retirement of Stormwater Retention Credits**

## **7.1      Stormwater Retention Credits Overview**

This chapter provides details on the eligibility requirements for certification of Stormwater Retention Credits (SRCs); the administrative process for certifying SRCs; the format for SRC serial numbers; the consequences for failure to maintain SRC-generating retention capacity; buying and selling SRCs; and voluntary retirement of SRCs. The chapter also explains how to calculate SRCs using DDOE’s calculator spreadsheet and provides some example calculations.

The following background, covered elsewhere in this Guidebook and the regulations, may be helpful in reviewing this chapter:

- One Stormwater Retention Credit (SRC) is equal to one gallon of retention for one year.
- One SRC can be used by a major regulated project to achieve one gallon of its Off-Site Retention Volume (Offv) for one year.
- The clock starts on an SRC’s one-year lifespan when it is used to satisfy an Offv.
- An unused SRC can be banked for future use without expiring.
- An SRC can be traded.
- An SRC can be voluntarily retired without being used.

## **7.2      Eligibility Requirements**

DDOE will certify Stormwater Retention Credits (SRCs) for eligible stormwater Best Management Practices (BMPs) and land cover in the District of Columbia. To be eligible, the retention capacity in a BMP or land cover must do the following:

- Achieve retention volume in excess of regulatory requirements, but less than the SRC ceiling;
- For unregulated projects or voluntary stormwater retrofits, achieve retention volume in excess of pre-project retention but less than the SRC ceiling;
- Be designed and installed in accordance with a DDOE-approved Stormwater Management Plan (SWMP) and the Stormwater Management Guidebook;
- Pass a post-construction inspection and ongoing maintenance inspections; and
- Provide a maintenance contract or maintenance agreement(s) for ongoing maintenance.

In addition, retention capacity installed must have been installed after May 1, 2009 in order to be eligible.

### **7.2.1 Eligibility Requirements: Retention Volume**

To be eligible, retention capacity must achieve retention in excess of stormwater management regulatory requirements or, for unregulated sites, in excess of pre-project retention.

For sites required to achieve a Stormwater Retention Volume (SWRV), eligible retention volume is the volume achieved in excess of the SWRV, but less than the SRC ceiling as shown in Figure 7.1.

For sites required to treat a water quality treatment volume (prior to establishment of SWRV requirements), eligible retention volume is the volume retained in excess of the stormwater treatment requirements in place at that time. For example, for a regulated site that provided treatment for the 0.5-inch storm by installing BMPs capable of retaining the 0.9-inch storm, the eligible retention volume would be the difference between the 0.9-inch storm volume and the 0.5-inch storm volume (i.e., 0.4-inch storm volume).

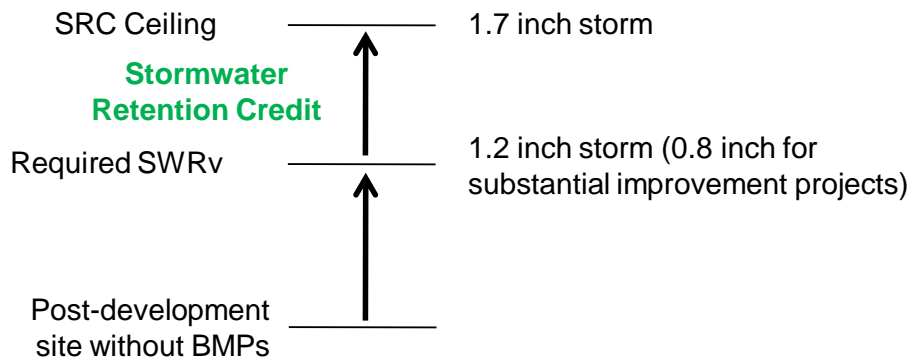
For sites that are unregulated or that would only trigger the regulations because of the voluntary installation of retention capacity, eligible retention volume is the volume achieved in excess of pre-project on-site retention, as shown in Figure 7.1.

Guidance on calculating volume eligibility of retention capacity for certification of SRCs is below, and an SRC calculation spreadsheet is available on DDOE's website.

In all cases, DDOE shall not certify SRCs for retention capacity in excess of the runoff volume expected to occur from a 1.7 inch rainfall event ("SRC Ceiling") (see Figure 7.1),



### 1: Regulated Sites Exceeding Required Stormwater Retention Volume (SWRv) on Site



### 2: Unregulated Sites Exceeding Existing Retention

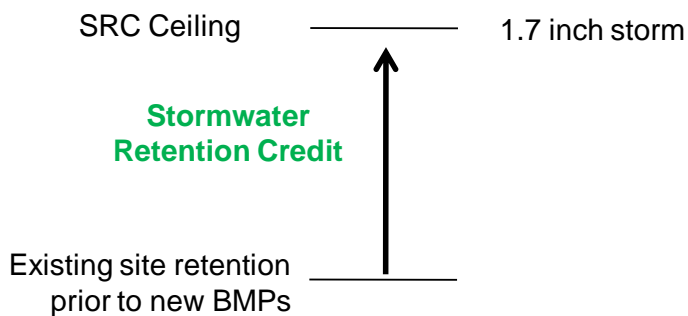


Figure 7.1 Retention volume eligible to earn SRCs.

#### 7.2.2 Eligibility Requirements: Design and Installation

To be eligible for SRC certification, retention BMPs or land covers must be designed and installed according to a DDOE-approved SWMP, with an as-built SWMP submitted to DDOE.

DDOE recognizes that some retention capacity, voluntarily installed prior to the establishment of retention standards, was installed without obtaining DDOE approval of a SWMP prior to installation. This retention capacity may still be eligible to earn SRCs. In such cases, DDOE will require an as-built SWMP stamped by a professional engineer licensed in the District of Columbia, as well as documentation of existing site conditions prior to the installation of the retention capacity. DDOE will consider such Applications for Certification of SRCs on a case-by-case basis and will determine eligible retention capacity in accordance with the specifications in this Stormwater Management Guidebook.

### **7.2.3 Eligibility Requirements: Inspection**

To be eligible for SRC certification, retention BMPs and land covers must pass DDOE's post-construction inspection and continue to pass inspections on an ongoing basis. DDOE typically inspects BMPs every three years but may also conduct unscheduled inspections of retention capacity, on a random basis or as a result of a potential problem that is identified by DDOE or the public.

### **7.2.4 Eligibility Requirements: Maintenance**

To be eligible for SRC certification, retention capacity must be maintained in good working order, as specified by DDOE. In an application for certification of SRCs, the proposed SRC owner (who becomes the original SRC owner once DDOE certifies the SRCs) signs a statement swearing to maintain the retention capacity for the period of time for which SRC certification is requested. To demonstrate the commitment to maintenance, the applicant must submit a current maintenance contract for the time period for which SRC certification is requested. Alternatively, applicants may conduct this maintenance, but they must demonstrate that they have the expertise and capacity to conduct the maintenance. The applicant shall submit the maintenance contract or other documentation of expertise and capacity as an attachment to the application for certification of SRCs.

## **7.3 Certification of Stormwater Retention Credits**

DDOE will accept applications for certification of SRCs once the regulations related to certification and ownership of SRCs are finalized in the *D.C. Register*. Required supporting documentation for the initial application includes the completed SRC calculation spreadsheet, as-built SWMP, and signed maintenance agreement or contract. Applications for retention capacity installed without prior DDOE approval of a SWMP must also provide documentation of site conditions prior to installation, including land cover type and existing retention BMPs. (See Chapter 2 and Appendix A for stormwater retention volume calculations.)

Appendix D contains the application form for certification of SRCs. Through the form, DDOE receives information that is necessary to track and record generated SRCs. Such information includes the address of the site with eligible retention capacity, the owner of proposed SRCs, and the owner's agent, among other information. Applicants should note the format for submitting information on the drainage areas and BMPs that will generate SRCs on a site. Applicants should assign each drainage area a letter (e.g., A, B, C) and each BMP a corresponding number (e.g., A1, B2, C3).

DDOE will review the application and supporting documentation to make a determination as to the number of SRCs to certify. DDOE will send its response to the proposed SRC owner who is listed on the application for certification. DDOE expects that the proposed SRC owner would very often be both the owner of the retention capacity and the owner of the property, but recognizes that this may not always be the case. If the proposed SRC owner is not the property owner, the proposed SRC owner must include documentation of the right to own the SRC applied for.

DDOE will certify up to three years' worth of SRCs for eligible retention capacity (the three-year period is based on DDOE's typical three-year inspection cycle). DDOE will assign each SRC a unique serial number for tracking purposes. At the end of that three-year period, the owner may apply for another three years' worth of SRCs. For example, for 1,000 gallons of eligible retention capacity, DDOE will certify up to 3,000 SRCs initially and an additional 3,000 SRCs at the beginning of each subsequent three-year period, as long as the eligibility requirements continue to be met.

An applicant should only apply for certification of SRCs corresponding to the period for which maintenance is planned. In applying for SRCs, an applicant commits to the maintenance of the retention capacity for the time period for which SRC certification is requested. Failure to maintain SRC-generating retention capacity is discussed below.

An applicant who wishes to have SRCs certified after the initial period of certification shall re-submit an application for certification of SRCs. The required supporting documentation for this re-submittal is a current maintenance contract or documentation of ongoing expertise and capacity to conduct the maintenance. DDOE expects to issue additional SRCs for retention capacity that has passed re-inspection and for which a submitted the commitment to maintain has been demonstrated.

**Key Milestones for the Generation of SRCs:**

1. Receive DDOE approval of proposed SWMP.
2. Install BMPs and/or land covers.
3. Pass DDOE's post-construction inspection.
4. Submit application for DDOE certification of SRCs, including:
  - (a) As-built SWMP;
  - (b) Current maintenance contract or documentation of expertise and capacity to conduct maintenance; and
  - (c) Documentation of the legal right to the SRCs applied for, if the proposed SRC owner is not the property owner.
5. Receive DDOE certification for up to three years' worth of SRCs.
6. Maintain retention capacity and pass subsequent inspections.\*
7. Submit application for DDOE certification of SRCs, including:
  - (a) Current maintenance contract or documentation of expertise and capacity to conduct maintenance and.
  - (b) Documentation of the legal right to the SRCs applied for, if the proposed SRC owner is not the property owner.\*
8. Receive DDOE certification for up to three years' worth of additional SRCs.\*

\*Steps 6, 7, and 8 can be repeated indefinitely



SRCs can be banked for future use without expiring. The one-year lifespan of an SRC begins once it is used to achieve an Offv.

#### Key Milestones in Transfer of SRC Ownership

1. Negotiate terms of transfer/contract between buyer and seller.
2. Submit application for transfer of SRC ownership to DDOE.
3. Receive DDOE confirmation of transfer of SRC ownership.

### 7.7 Voluntary Retirement of Stormwater Retention Credits

An SRC owner can request that an SRC be retired by submitting an application to retire SRCs.

### 7.8 Quitting the Obligation to Maintain Retention for Stormwater Retention Credits

An original SRC owner can quit the obligation to maintain retention capacity for which an SRC is certified. If the SRC has not been sold or used to satisfy an Offv, the owner may submit an application to retire the SRC. If the SRC was sold or used, the original owner may request that DDOE retire another SRC in its place or pay the in-lieu fee to compensate.

### 7.9 Calculation of Stormwater Retention Credits

A person should use DDOE's SRC calculator spreadsheet, available on DDOE's website, to calculate the retention capacity on a site that meets the retention volume eligibility requirement. As discussed above, retention capacity must also meet eligibility requirements for design and installation; inspection; and maintenance in order for DDOE to certify SRCs.

Use of the SRC calculator spreadsheet is discussed below. The calculator allows SRC calculation for multiple drainage areas on a site.

Note that major regulated projects that are interested in exceeding the required SWRv in order to generate SRCs should input data in the SRC calculator's Existing Retention section based on the proposed site conditions upon achievement of the SWRv. Any changes to land cover and retention above and beyond the SWRv should be input in the Proposed Retention section. Scenario 3 in Section 7.9 is an example of a major regulated project that exceeds the SWRv in order to generate SRCs.

On the SRC calculator spreadsheet, cells highlighted in blue are user input cells. Cells highlighted in gray are calculation cells, and cells highlighted in yellow are constant values.

The steps given below are meant to be followed while working with DDOE's SRC calculator spreadsheet. Note that **only entry of input data is required by users**—no manual calculations are required except when more than 4 BMPs are present or proposed in each drainage area for steps 1 C and 2 C (adding up BMP retention). The equations utilized in the spreadsheet are given below for informational purposes.

**Step 1: Determine pre-project retention for drainage area 1.**

- (a) Input area of each pre-project land cover, including Impervious Cover, Compacted Cover, and Natural Cover in **lines 14–16**. Guidance for various land covers is provided in Appendix O and Table A.1 of Appendix A.
- (b) Automatic calculation of retention provided by pre-project land cover. This is equivalent to the abstraction provided by the land, determined by modifying the formula for calculating the SWR<sub>v</sub>. The calculation applies a retention coefficient (0.05 for Impervious Cover, 0.75 for Compacted Cover, and 1.0 for Natural Cover) to each of the land cover areas, using the 1.7-inch storm depth. (**line 17**).

$$ER_{LC} = (0.05 \times EIA + 0.75 \times ECCA + 1.0 \times ENA) \times \frac{PC}{12} \times 7.48$$

where:

$ER_{LC}$	=	retention from the existing (pre-project) land cover (gal) ( <b>line 17</b> )
$EIA$	=	existing (pre-project) impervious cover area (ft <sup>2</sup> ) ( <b>line 14</b> )
$ECCA$	=	existing (pre-project) compacted cover area (ft <sup>2</sup> ) ( <b>line 15</b> )
$EN$	=	existing (pre-project) natural area (ft <sup>2</sup> ) ( <b>line 16</b> )
$PC$	=	precipitation ceiling (in.) ( <b>line 10</b> )

- (c) Input each existing retention BMP in **lines 20–23**. If there are more than four existing BMPs, sum the additional BMP retention volumes (for example, BMP 4 + BMP 5 + BMP 6 + ...) by drainage area in the last row (**line 23**).
- (d) Automatic calculation of the total existing retention as sum of existing retention by land (**line 17**) and existing retention by BMPs (**lines 20 through 23**). (**line 25**).

$$ER_T = ER_{LC} + ER_{P1} + ER_{P2} + ER_{P3} + ER_{P4,5,6,etc.}$$

where:

$ER_T$	=	total existing (pre-project) retention (gal) (line 25)
$ER_{LC}$	=	retention from the existing (pre-project) land cover (gal) ( <b>line 17</b> )
$ER_{P1}$	=	retention from first existing (pre-project) BMP (gal) ( <b>line 20</b> )
$ER_{P2}$	=	retention from second existing (pre-project) BMP (gal) ( <b>line 21</b> )
$ER_{P3}$	=	retention from third existing (pre-project) BMP (gal) ( <b>line 22</b> )
$ERP_{4,5,6,ect.}$	=	retention from third existing (pre-project) BMP (gal) ( <b>line 23</b> )

**Step 2: Determine proposed retention for drainage area 1.**

- (a) Input the proposed land cover including Impervious Cover, Compacted Cover, and Natural Cover in **lines 28-30**. Guidance for various land covers is provided in Table A.1 and Appendix O.
- (b) Automatic calculation of retention provided by proposed land cover. This is equivalent to the abstraction provided by the land, determined by modifying the formula for calculating the

SWRv. The calculation applies a retention coefficient (0.05 for Impervious Cover, 0.75 for compacted cover, and 1.0 for natural cover) to each of the land cover areas, using the 1.7-inch storm depth. (**line 31**).

$$PR_{LC} = (0.05 \times PIA + 0.75 \times PCCA + 1.0 \times PNA) \times \frac{PC}{12} \times 7.48$$

where:

$PR_{LC}$	=	retention from the proposed land cover (gal) ( <b>line 31</b> )
$PIA$	=	proposed impervious cover area (ft <sup>2</sup> ) ( <b>line 28</b> )
$PCCA$	=	proposed compacted cover area (ft <sup>2</sup> ) ( <b>line 29</b> )
$PNA$	=	proposed natural area (ft <sup>2</sup> ) ( <b>line 30</b> )
$PC$	=	precipitation ceiling (in.) (line 10)

- (c) C. Input each proposed retention BMP in **lines 34-37**. If there are more than four existing BMPs, sum the additional BMP retention volumes (for example, BMP 4 + BMP 5 + BMP 6 + ...) by drainage area in the last row (**line 37**).
- (d) D. Automatic calculation of the total proposed retention as a sum of proposed retention by land (**line 31**) and proposed retention by BMPs (**lines 34 through 37**). (**line 39**).

$$PR_T = PR_{LC} + PR_{P1} + PR_{P2} + PR_{P3} + PR_{P4,5,6,etc.}$$

where:

$PR_T$	=	total proposed retention (gal) ( <b>line 39</b> )
$PR_{LC}$	=	retention from the proposed land cover (gal) ( <b>line 31</b> )
$PR_{P1}$	=	retention from first proposed BMP (gal) ( <b>line 34</b> )
$PR_{P2}$	=	retention from second proposed BMP (gal) ( <b>line 35</b> )
$PR_{P3}$	=	retention from third proposed BMP (gal) ( <b>line 36</b> )
$PRP_{4,5,6,ect.}$	=	retention from third proposed BMP (gal) ( <b>line 37</b> )

### **Step 3: Calculate SRCs for drainage area 1.**

- (a) A. Automatic calculation of SRC-eligible volume. The total pre-project retention (line 25) is subtracted from the total proposed retention (line 39) providing an initial calculation of SRCs in **line 42**.

$$PAR_T = PR_T - ER_T$$

where:

$PAR_T$	=	proposed additional retention (gal) ( <b>line 42</b> )
$PR_T$	=	total proposed retention (gal) ( <b>line 39</b> )
$ER_T$	=	total existing (pre-project) retention (gal) ( <b>line 25</b> )

**Step 4: Verify SRC-Eligible Volume against maximum allowable for drainage area 1.**

- (a) Automatic calculation of SRC ceiling, based on runoff from pre-project land cover, with P=1.7 inches (**line 45**).

$$SRC_{Ceiling} = (0.95 \times EIA + 0.25 \times ECCA + 0 \times ENA) \times \frac{PC}{12} \times 7.48$$

where:

$SRC_{Ceiling}$	=	stormwater retention credit ceiling (gal) ( <b>line 45</b> )
$EIA$	=	existing (pre-project) impervious cover area (ft <sup>2</sup> ) ( <b>line 14</b> )
$ECCA$	=	existing (pre-project) compacted cover area (ft <sup>2</sup> ) ( <b>line 15</b> )
$ENA$	=	existing (pre-project) natural cover area (ft <sup>2</sup> ) ( <b>line 16</b> )
$PC$	=	precipitation ceiling (in.) ( <b>line 10</b> )

- (b) Automatic calculation of maximum allowable number of SRCs. SRCs shall not exceed maximum allowable SRCs, as defined by the difference between the SRC Ceiling and the sum of Pre-Project BMP Retention (**line 46**).

$$SRC_{Maximum} = SRC_{Ceiling} - (ER_{P1} + ER_{P2} + ER_{P3} + ER_{P4,5,6,etc.})$$

where:

$SRC_{Maximum}$	=	maximum stormwater retention credit allowable (gal) ( <b>line 46</b> )
$SRC_{Ceiling}$	=	stormwater retention credit ceiling (gal) ( <b>line 45</b> )
$ER_{P1}$	=	retention from first existing (pre-project) BMP (gal) ( <b>line 20</b> )
$ER_{P2}$	=	retention from second existing (pre-project) SBMP (gal) ( <b>line 21</b> )
$ER_{P3}$	=	retention from third existing (pre-project) BMP (gal) ( <b>line 22</b> )
$ER_{P4,5,6,etc.}$	=	retention from third existing (pre-project) BMP (gal) ( <b>line 23</b> )

- (c) Automatic output of SRC-eligible volume for drainage area 1 by comparing initial calculation of SRCs against maximum allowable (**line 48**).

if:

$$PAR_T < SRC_{Maximum}, \text{ then } SRC_{Eligible} = PAR_T$$

otherwise:

$$SRC_{Eligible} = SRC_{Maximum}$$

where:

$SRC_{Eligible}$	=	eligible Stormwater Retention Credit (gal) ( <b>line 48</b> )
$SRC_{Maximum}$	=	maximum Stormwater Retention Credit Allowable (gal) ( <b>line 46</b> )
$PAR_T$	=	proposed Additional Retention (gal) ( <b>line 42</b> )



**Step 5: Repeat steps 1-4 for each applicable drainage area**

Five drainage area columns are provided. Sites with more than five drainage areas will require additional spreadsheets.

**Step 6: Total SRC-Eligible Volume**

- (a) Automatic calculation of the total eligible SRC gallons for the site by summing SRC-eligible volume for each drainage areas in **line 50**.

$$SRC_{Eligible-Site} = SRC_{Eligible-A} + SRC_{Eligible-B} + SRC_{Eligible-C} + SRC_{Eligible-D}$$

where:

- $SRC_{Eligible-Site}$  = total eligible SRC for the entire site (gal) (**line 50**)
- $SRC_{Eligible-A}$  = total eligible SRC for Drainage Area A (gal) (**line 48**)
- $SRC_{Eligible-B}$  = total eligible SRC for Drainage Area B (gal) (**line 48**)
- $SRC_{Eligible-C}$  = total eligible SRC for Drainage Area C (gal) (**line 48**)
- $SRC_{Eligible-D}$  = total eligible SRC for Drainage Area D (gal) (**line 48**)

## 7.10 Stormwater Retention Credit Calculation Scenarios

### Scenario 1

The site has a single drainage area. The parcel is a 5,000-square foot rectangle. There are two land covers on the site: a 4,000-square foot parking lot and an adjacent 1,000-square foot grass area that is regularly mowed. The parking lot is defined as impervious surface and the mowed grass area is defined as compacted cover. The owner contemplates converting 1,000 square feet of parking surface into a bioretention, which is defined as impervious. Using Chapter 3.5 Bioretention, the proposed BMP is designed to retain 1,500 gallons of runoff from the parking lot.

**5,000 square  
foot parcel**

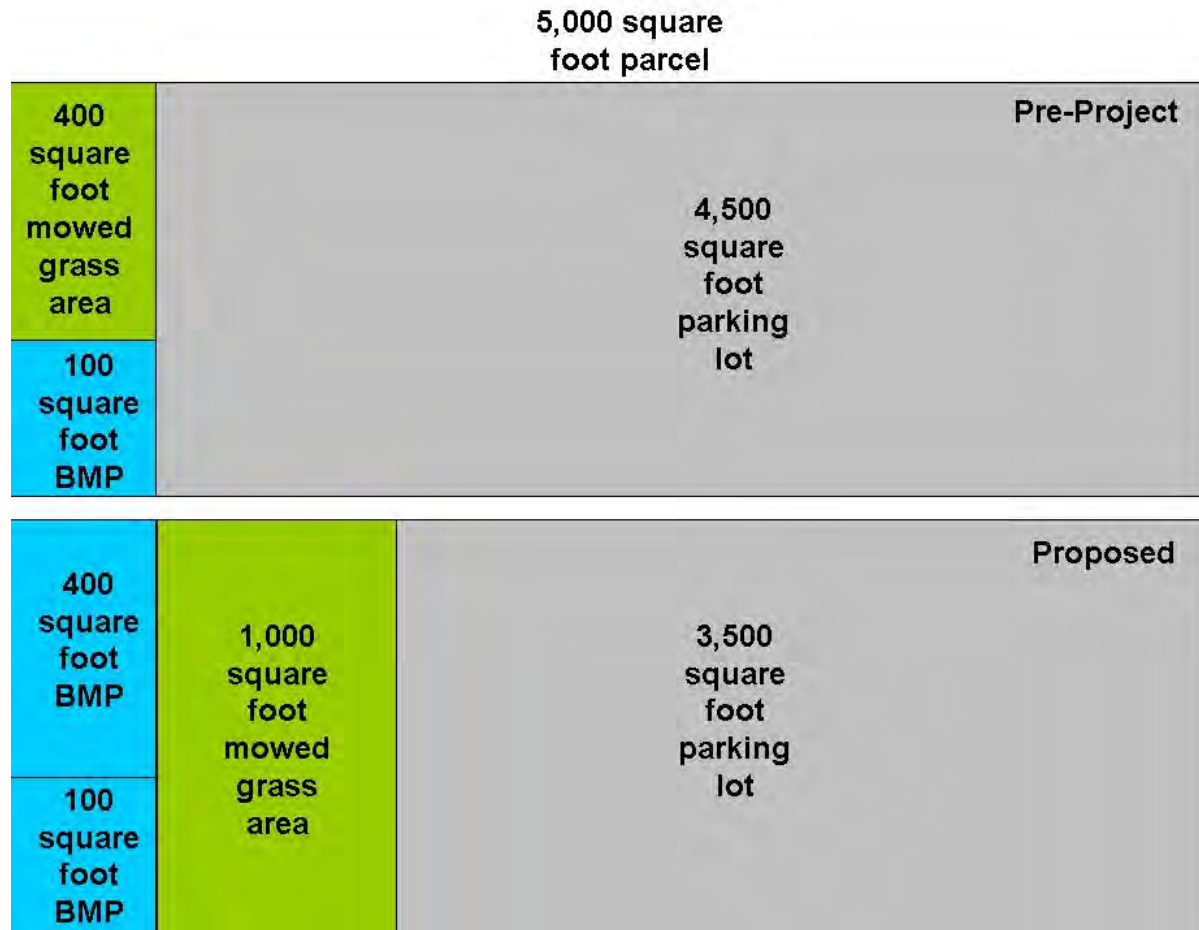


Step 1: Pre-Project Retention	Drainage Area				
	A	B	C	D	E
Impervious Area (ft <sup>2</sup> )	4,000	0	0	0	0
Compacted Cover Area (ft <sup>2</sup> )	1,000	0	0	0	0
Natural Area (ft <sup>2</sup> )	0	0	0	0	0
Retention from Pre-Project Land Cover (gal)	1,007	0	0	0	0
Retention from Pre-Project Best Management Practice (BMP)					
BMP 1 (gal)	0	0	0	0	0
BMP 2 (gal)	0	0	0	0	0
BMP 3 (gal)	0	0	0	0	0
Add together BMP 4, 5, 6, etc.(gal)	0	0	0	0	0
Total Pre-Project Retention (gal)	1,007	0	0	0	0
Step 2: Proposed Retention					
Impervious Area (ft <sup>2</sup> )	4,000	0	0	0	0
Compacted Cover Area (ft <sup>2</sup> )	1,000	0	0	0	0
Natural Area (ft <sup>2</sup> )	0	0	0	0	0
Retention from Proposed Land Cover (gal)	1,007	0	0	0	0
Retention from Proposed BMP - include BMPs retained from pre-project conditions					
BMP 1 (gal)	1,500	0	0	0	0
BMP 2 (gal)	0	0	0	0	0
BMP 3 (gal)	0	0	0	0	0
Add together BMP 4, 5, 6, etc.(gal)	0	0	0	0	0
Total Proposed Retention (gal)	2,507	0	0	0	0
Step 3: Calculate SRCs (internal calculation)					
Total Additional Retention Proposed	1,500	0	0	0	0
Step 4: Verify SRCs (internal calculation)					
SRC Ceiling	4,292	0	0	0	0
Maximum SRCs (based on Pre-Project BMP)	4,292	0	0	0	0
SRC Eligible Volume (gal)	1,500	0	0	0	0
<b>Site Total SRC Eligible Volume (gal)</b>	<b>1,500</b>				

### Scenario 2

The site has a single drainage area. The parcel is a 5,000-square foot rectangle and is divided between a 4,500-square foot parking lot and an adjacent 400-square foot grass area that is regularly mowed. There is an existing bioretention (the land areas of all BMPs are considered impervious) covering 100 square feet and determined to retain 1,000 gallons using Chapter 3.5. The parking lot is defined as impervious surface and the mowed grassy area is defined as compacted cover. The owner contemplates converting the grass area into bioretention and reducing the parking lot size by 1,000 square feet, with that area converted into mowed grass. Using Chapter 3.5 Bioretention, the proposed 400-square foot BMP is designed to retain 1,500

gallons of runoff from the parking lot in addition to the 1,000 gallons retained by the original BMP.

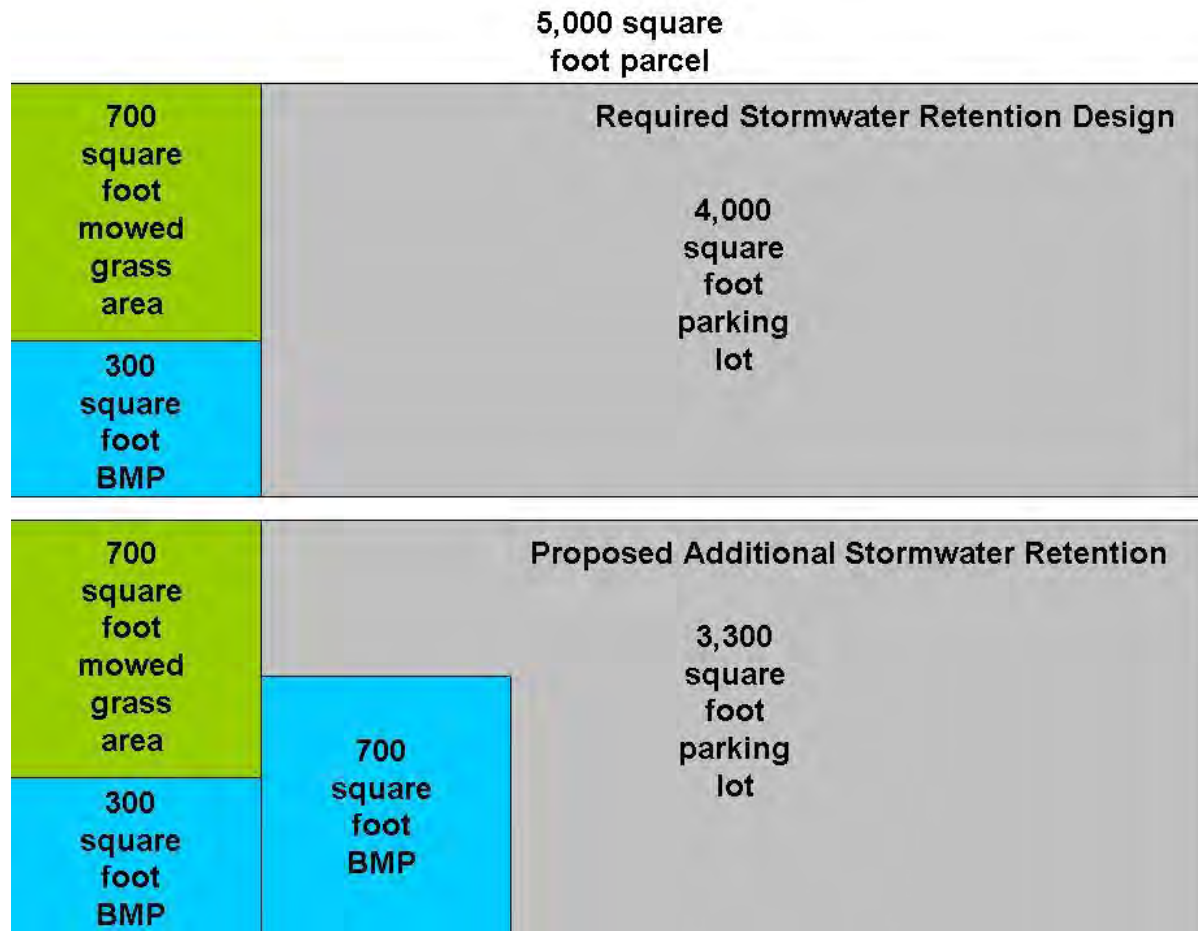


Step 1: Pre-Project Retention	Drainage Area				
	A	B	C	D	E
Impervious Area (ft <sup>2</sup> )	4,600	0	0	0	0
Compacted Cover Area (ft <sup>2</sup> )	400	0	0	0	0
Natural Area (ft <sup>2</sup> )	0	0	0	0	0
Retention from Pre-Project Land Cover (gal)	562	0	0	0	0
Retention from Pre-Project Best Management Practice (BMP):					
BMP 1 (gal)	1,000	0	0	0	0
BMP 2 (gal)	0	0	0	0	0
BMP 3 (gal)	0	0	0	0	0
Add together BMP 4, 5, 6, etc. (gal)	0	0	0	0	0
Total Pre-Project Retention (gal)	1,562	0	0	0	0
Step 2: Proposed Retention					
Impervious Area (ft <sup>2</sup> )	4,000	0	0	0	0
Compacted Cover Area (ft <sup>2</sup> )	1,000	0	0	0	0
Natural Area (ft <sup>2</sup> )	0	0	0	0	0
Retention from Proposed Land Cover (gal)	1,007	0	0	0	0
Retention from Proposed BMP - include BMPs retained from pre-project conditions					
BMP 1 (gal)	1,000	0	0	0	0
BMP 2 (gal)	1,500	0	0	0	0
BMP 3 (gal)	0	0	0	0	0
Add together BMP 4, 5, 6, etc. (gal)	0	0	0	0	0
Total Proposed Retention (gal)	3,507	0	0	0	0
Step 3: Calculate SRCs (internal calculation)					
Total Additional Retention Proposed	1,945	0	0	0	0
Step 4: Verify SRCs (internal calculation)					
SRC Ceiling	4,737	0	0	0	0
Maximum SRCs (based on Pre-Project BMP)	3,737	0	0	0	0
SRC Eligible Volume (gal)	1,945	0	0	0	0
<b>Site Total SRC Eligible Volume (gal)</b>	<b>1,945</b>				

### Scenario 3

The site is a proposed development with land disturbance activities that trigger the stormwater regulation. We limit the scenario to one of several drainage areas within the project's limits of disturbance. The drainage area is 5,000 square feet. It will contain a newly constructed 4,000-square foot parking lot and an adjacent existing 700-square foot grass area that is regularly mowed. A proposed bioretention will manage parking lot runoff and cover 300 square feet. This bioretention will retain 3,186 gallons based on Chapter 3.5. In this scenario, these gallons are the regulated stormwater retention volume (SWRV) for this drainage area. The parking lot and the bioretention are defined as impervious surface, and the mowed grass area is defined as

compacted cover. The owner contemplates converting 700 square feet of parking lot into bioretention to gain additional retention gallons above the regulatory obligation. Using Chapter 3.5 Bioretention, the additional 700 square feet will provide 3,000 gallons of additional retention.



Step 1: Pre-Project Retention	Drainage Area				
	A	B	C	D	E
Impervious Area (ft <sup>2</sup> )	4,300	0	0	0	0
Compacted Cover Area (ft <sup>2</sup> )	700	0	0	0	0
Natural Area (ft <sup>2</sup> )	0	0	0	0	0
Retention from Pre-Project Land Cover (gal)	784	0	0	0	0
Retention from Pre-Project Best Management Practice (BMP):					
BMP 1 (gal)	3,186	0	0	0	0
BMP 2 (gal)	0	0	0	0	0
BMP 3 (gal)	0	0	0	0	0
Add together BMP 4, 5, 6, etc.(gal)	0	0	0	0	0
<b>Total Pre-Project Retention (gal)</b>	<b>3,970</b>	<b>0</b>	<b>0</b>	<b>0</b>	<b>0</b>
<b>Step 2: Proposed Retention</b>					
Impervious Area (ft <sup>2</sup> )	4,300	0	0	0	0
Compacted Cover Area (ft <sup>2</sup> )	700	0	0	0	0
Natural Area (ft <sup>2</sup> )	0	0	0	0	0
Retention from Proposed Land Cover (gal)	784	0	0	0	0
Retention from Proposed BMP - include BMPs retained from pre-project conditions:					
BMP 1 (gal)	3,186	0	0	0	0
BMP 2 (gal)	3,000	0	0	0	0
BMP 3 (gal)	0	0	0	0	0
Add together BMP 4, 5, 6, etc.(gal)	0	0	0	0	0
<b>Total Proposed Retention (gal)</b>	<b>6,970</b>	<b>0</b>	<b>0</b>	<b>0</b>	<b>0</b>
<b>Step 3: Calculate SRCs (internal calculation)</b>					
<b>Total Additional Retention Proposed</b>	<b>3,000</b>	<b>0</b>	<b>0</b>	<b>0</b>	<b>0</b>
<b>Step 4: Verify SRCs (internal calculation)</b>					
SRC Ceiling	4,514	0	0	0	0
Maximum SRCs (based on Pre-Project BMP)	1,328	0	0	0	0
<b>SRC Eligible Volume (gal)</b>	<b>1,328</b>	<b>0</b>	<b>0</b>	<b>0</b>	<b>0</b>
<b>Site Total SRC Eligible Volume (gal)</b>	<b>1,328</b>				

See Appendix D for the following forms for use by the applicant:

- Application for Certification of Stormwater Retention Credits
- Application for Transfer of Stormwater Retention Credit Ownership
- Application to Retire Stormwater Retention Credits





# Appendix A Compliance Calculations and Design Examples

## A.1 Compliance Calculations

All major regulated projects are required to address the Stormwater Retention Volume (SWRv), and major regulated projects in the Anacostia Waterfront Development Zone (AWDZ) are required to address the Water Quality Treatment Volume (WQTV), as described in Chapter 2. Section A.2 provides guidance on using the General Retention Compliance Calculator. The resulting worksheets from this Excel program must be submitted with the Stormwater Management Plan (SWMP) for retention approval. Achieving detention obligations may be demonstrated with these worksheets or other hydrologic methods and models as detailed in Chapter 2.6 and Appendix H.

## A.2 District of Columbia Stormwater Compliance Spreadsheet

The following guidance goes through the use of each of the worksheet tabs in the General Retention Compliance Calculator.

Note: All cells highlighted in blue are user input cells. Cells highlighted in gray are calculation cells, and cells highlighted in yellow are constant values that generally should not be changed.

### Site Data Sheet

1. Input the name of the proposed project on **line 9**.
2. Determine if the site is located in the AWDZ and note in **cell E13**.
3. Determine if the site is located in the MS4 and note in **cell E14**.
4. The regulatory rain event for calculation of the SWRv varies depending upon the type of development. For major land-disturbing activities, the SWRv is based upon the 90th percentile depth (1.2 inches). For major substantial improvements, the SWRv is based upon the 80th percentile depth (0.8 inches). If the site is in the AWDZ and undergoing major substantial improvement, the SWRv is based upon the 85th percentile depth (1.0 inches). Choose the type of development on **line 15**. The regulatory rain event for SWRv will be shown on **line 16**, and the regulatory rain event for the WQTV (if applicable) will be shown on **line 17**.
5. For the site, indicate the area (in square feet) of post-development Natural Cover, Compacted Cover, and Best Management Practice (BMP) surface area in **cells D22-D25**. Guidance for various land covers is provided in Table A.1. Efforts to reduce Impervious Cover on the site and maximize Natural Cover will reduce the required Stormwater Retention Volume (SWRv). Portions of a project located in the Public Right-of-Way should be considered

separately from the rest of the site and surface area by cover type should be indicated in **cells E22-E25**.

Note: This step will be iterative as BMP sizing is performed, and the area of both BMPs and other land cover types are adjusted.

- From the land cover input, weighted site-runoff coefficients ( $R_v$ ) will be calculated (**line 33**) for both the site and the public right-of-way based upon the land cover  $R_v$  values of 0.00 for Natural Cover, 0.25 for Compacted Cover, and 0.95 for Impervious Cover.

$$\%N = A_N/SA \times 100$$

$$\%C = A_C/SA \times 100$$

$$\%I = A_I/SA \times 100$$

$$R_v = (\%N \times R_{vN} + \%C \times R_{vC} + \%I \times R_{vI})$$

where:

$\%N$	=	percent of site in natural cover
$A_N$	=	area of post-development natural cover (ft <sup>2</sup> )
$\%C$	=	percent of site in compacted cover
$A_C$	=	area of post-development compacted cover (ft <sup>2</sup> )
$\%I$	=	percent of site in impervious cover
$A_I$	=	area of post-development impervious cover (ft <sup>2</sup> )
$SA$	=	total site area (ft <sup>2</sup> )
$R_v$	=	weighted site runoff coefficient
$R_{vN}$	=	runoff coefficient for natural cover (0.00)
$R_{vC}$	=	runoff coefficient for compacted cover (0.25)
$R_{vI}$	=	runoff coefficient for impervious cover (0.95)

- The  $SWR_v$  that must be retained on the site and in the PROW will be calculated on **line 37**.

$$SWR_v = P/12 \times R_v \times SA$$

where:

$SWR_v$	=	stormwater retention volume (ft <sup>3</sup> )
$P$	=	regulatory rain event (in.)
12	=	conversion from inches to feet
$R_v$	=	weighted site runoff coefficient
$SA$	=	total site area (ac)

8. If the site is in the AWDZ, the WQTV that must be treated on site and in the PROW will be calculated on **line 39**. The regulatory rain event for calculation of the WQTV is based upon the 95th percentile depth (1.7 inches).

$$WQTV = P/12 \times Rv \times SA$$

where:

- $WQTV$  = stormwater treatment volume (ft<sup>3</sup>)
- $P$  = regulatory rain event (1.7 in.)
- 12 = conversion from inches to feet
- $Rv$  = weighted site runoff coefficient
- $SA$  = total site area (ac)

**Table A.1 Land Cover Guidance for General Retention Compliance Calculator, consult Appendix O for more details.**

<b>NATURAL COVER</b>
<p>Land that will remain undisturbed and exhibits hydrologic properties equal to or better than meadow in good condition OR land that will be restored to such a condition. This includes:</p> <ul style="list-style-type: none"> <li>▪ Portions of residential yards in forest cover that will NOT be disturbed during construction.</li> <li>▪ Community open space areas that will not be mowed routinely, but left in a natural vegetated state (can include areas that will be rotary mowed no more than two times per year).</li> <li>▪ Utility rights-of-way that will be left in a natural vegetated state (can include areas that will be rotary mowed no more than two times per year).</li> <li>▪ Other areas of existing forest and/or open space that will be protected during construction and that will remain undisturbed.</li> </ul> <p><u>Operational and Management Conditions in Natural Cover Category:</u></p> <ul style="list-style-type: none"> <li>▪ Undisturbed portions of yards, community open space, and other areas that will be considered as forest/open space must be shown outside the Limits of Disturbance (LOD) on an approved Soil Erosion and Sediment Control Plan (SESCP) AND demarcated in the field (e.g., fencing) prior to commencement of construction.</li> <li>▪ Portions of roadway rights-of-way that will count as natural cover are assumed to be disturbed during construction, and must follow the most recent design specifications for soil restoration and, if applicable, site reforestation, as well as other relevant specifications if the area will be used as a BMP.</li> <li>▪ All areas that will be considered natural cover for stormwater purposes must have documentation that prescribes that the area will remain in a natural, vegetated state. Appropriate documentation includes: subdivision covenants and restrictions, deeded operation and maintenance agreements and plans, parcel of common ownership with maintenance plan, third-party protective easement, within public right-of-way or easement with maintenance plan, or other documentation approved by DDOE.</li> <li>▪ While the goal is to have natural cover areas remain undisturbed, some activities may be prescribed in the appropriate documentation, as approved by DDOE: forest management, control of invasive species, replanting and revegetation, passive recreation (e.g., trails), limited bush hogging to maintain desired vegetative community, etc.</li> <li>▪ Land that will undergo conversion from compacted cover or impervious cover to natural cover must follow the guidelines for compost amended soils in Appendix K.</li> </ul>

<b>COMPACTED COVER</b>
Land disturbed and/or graded for eventual use as managed turf or landscaping. Managed turf comprises of areas that are graded or disturbed, and maintained as turf, including yard areas, septic fields, residential utility connections, and roadway rights of way. Landscaping includes areas that are intended to be maintained in vegetation other than turf within residential, commercial, industrial, and institutional settings.
<b>IMPERVIOUS COVER</b>
Roadways, driveways, rooftops, parking lots, sidewalks, and other areas of impervious cover. While they are noted separately in the spreadsheet, the surface area of all BMPs, <u>except</u> disconnection areas are included with impervious cover in the spreadsheet's calculations.

### Drainage Area Sheets 1-5

If the site has multiple discharge points, or complex treatment sequences, it must be divided into individual drainage areas (DAs). For each DA, a minimum of 50 percent of the SWR<sub>v</sub> must be retained. In the MS4, if 50 percent of the SWR<sub>v</sub> cannot be retained, that volume (or equivalent 24-hour storm) must be captured and treated with an accepted TSS treatment practice.

For each DA sheet:

1. Indicate the specific area of post-development Natural Cover, Compacted Cover, Impervious Cover, Vehicular Access, and BMP surface area in **lines 6–10**. The SWR<sub>v</sub> for the DA will be calculated in **cell G11**, and the WQT<sub>v</sub> (if in the AWDZ) will be calculated in **cell G15**.

Note: This step will be iterative as BMP sizing is performed, and the area of both BMPs and other land cover types is adjusted. Vehicular Access Areas are a sub-category of Impervious Cover. Therefore, the Vehicular Access Areas must be included as a part of the total Impervious Cover area.

2. Apply BMPs to the drainage area to address the required SWR<sub>v</sub> and WQT<sub>v</sub> by indicating the area in square feet of compacted cover, impervious cover, and vehicular access areas (see not above) to be treated by a given BMP in **Columns B, D, and F** (or the number of trees in the case of tree preservation or planting). This will likely be an iterative process. The available BMPs include the following:

- ◆ Green Roof
- ◆ Rainwater Harvesting
- ◆ Simple Disconnection to a Pervious Area
- ◆ Simple Disconnection to a Conservation Area
- ◆ Simple Disconnection to Amended Soils
- ◆ Permeable Pavement - Enhanced
- ◆ Permeable Pavement - Standard
- ◆ Bioretention - Enhanced
- ◆ Bioretention - Standard
- ◆ Stormwater Filtering Systems

- ◆ Stormwater Infiltration
  - ◆ Storage
  - ◆ Stormwater Ponds
  - ◆ Wetlands
  - ◆ Grass Channel
  - ◆ Grass Channel with Amended Soils
  - ◆ Dry Swale
  - ◆ Wet Swale
  - ◆ Proprietary Practice
  - ◆ Tree Planting
  - ◆ Tree Preservation
3. Based upon the area input for a given BMP, the spreadsheet will calculate the Maximum Retention Volume Received by BMP in **column H**. Regardless of the Regulatory Rainfall Event that applies to the site, the volume calculated in column F is based on a rainfall depth of 1.7 inches. Therefore, the value in **column H** represents the greatest retention volume for which a BMP can be valued, rather than the volume that must be retained to achieve compliance. In other words, it is possible to “oversize” BMPs in one drainage area and “undersize” others to achieve compliance. However, as noted above, in the MS4, a minimum of 50 percent of the SWRV must be retained in each drainage area. Otherwise, treatment of the remaining runoff to reach 50 percent of the SWRV must be provided by an accepted TSS treatment practice.

$$V_{max} = 1.7/12 \times (Rv_N \times A_{NC} + Rv_C \times A_C + Rv_I \times (A_I + A_{BMP}))$$

where:

- $V_{max}$  = volume received by the BMP from 1.7-inch rain event (ft<sup>3</sup>)
- $Rv_N$  = runoff coefficient for natural cover (0.00)
- $A_N$  = area of post-development natural cover (ft<sup>2</sup>)
- $Rv_C$  = runoff coefficient for compacted cover (0.25)
- $A_C$  = area of post-development compacted cover (ft<sup>2</sup>)
- $Rv_I$  = runoff coefficient for impervious cover (0.95)
- $A_I$  = area of post-development impervious cover (ft<sup>2</sup>)
- $A_{BMP}$  = area of BMP (ft<sup>2</sup>)

4. As noted in Chapter 2, for all vehicular access areas, a minimum of 50% of the SWRV must also be retained or treated. This volume is calculated for each BMP in **column G** as follows:

$$V = \text{RRE}/12 \times \text{Rv}_I \times A_v \times 0.5$$

where:

- V = volume received by the BMP from vehicular access areas that must be retained or treated (ft<sup>3</sup>)
- RRE = Regulatory Rain Event for SWR<sub>v</sub> (in)
- Rv<sub>I</sub> = runoff coefficient for impervious cover (0.95)
- A<sub>v</sub> = area of vehicular access area (ft<sup>2</sup>)

5. If more than one BMP will be employed in series, any overflow from upstream BMPs will be accounted for in **column L**, and the total volume directed to the BMP will be summed in **column M**.
6. For most BMPs it is necessary to input the surface area of the BMP and/or the storage volume of the BMP in **columns N** and **O**. These should be calculated using the equations provided in Chapter 3.
7. The spreadsheet calculates a retention volume value in **column N**, based on the value descriptions in **columns I–K**. Regardless of the storage volume of the BMP, the retention volume value cannot be greater than the total volume received by the BMP (**column M**).
8. The Potential Retention Volume Remaining (**column Q**) equals the total volume received by the BMP minus the retention volume value.
9. BMPs that have a less than 100 percent retention value and are accepted TSS treatment practices are assigned additional treatment volume based upon the lesser of the runoff volume received by the BMP and the actual storage volume minus the retention value. This additional treatment volume is indicated in **column R**.
10. Any potential retention volume remaining (**column Q**) can be directed to a downstream BMP in **column S** by selecting from the pull-down menu. Selecting a BMP from the menu will automatically direct the retention volume remaining to **column L** for the appropriate BMP.
11. **Column T** calculates whether or not the vehicular access area directed to each BMP is adequately addressed, via retention or treatment. To do this, the required runoff volume from the vehicular access area is compared to the retention and treatment volumes provided by the BMP, as well as from a downstream BMP, if selected. For each BMP that receives vehicular access runoff, “Yes” or “No” will be displayed. It should be noted that while this column does take downstream BMPs into account, it is not a precise enough check to ensure that all possible design variations are accounted for. Sufficient retention or treatment from vehicular access areas must be clearly shown on the design plans.
12. From the selected BMPs, the total volume retained will be summed in **cell P66**. The retention volume remaining will then be calculated as the difference between the SWR<sub>v</sub> and the total volume retained in **cell P68** (in cubic feet) and **cell P69** (in gallons). **Cell P71** indicates if at least 50 percent of the SWR<sub>v</sub> has been retained for the DA.
13. **Cell P72** indicates whether or not all of the vehicular access areas have been adequately addressed. This is accomplished with two checks. First, the cell checks that the entire

vehicular access area for the drainage area indicated in **cell B9** has been included in **column F**, by comparing **cell F66** to **cell B9**. Second, the cell checks that sufficient retention or treatment volume has been provided in each BMP by searching for “No’s” in **column T**. As noted above, this check is not precise enough to ensure that all possible design variations are accounted for. Sufficient retention or treatment from vehicular access areas must be clearly shown on the design plans.

14. If in the MS4, if 50 percent of the SWRv has not been retained, **cell P73** indicates that treatment is required.
15. From the selected BMPs, **cell T66** is the sum of the total volume treated. If treatment is required due to a shortage of retention, **cells T68** (cubic feet) and **T69** (gallons) indicate how much more runoff must be treated. If treatment is required because the site is located in the AWDZ, **cells T71** (cubic feet) and **T72** (gallons) indicate how much runoff must be treated to meet WQTV requirements.
16. **Cell P75** will indicate compliance for the DA with a “Yes” or “No,” depending on retention and treatment volume provided in the drainage area. Note: Since only 50 percent of the SWRv must be retained in any individual DA, compliance in each drainage area does not automatically mean that compliance for the entire site has been achieved.

### Public Right-of-Way Sheet

The Public Right-of-Way sheet is functionally identical to the Drainage Area; therefore, **steps 1–16** should be followed as stated above. If SWRv or WQTV is not met, the site may still comply if it follows the Maximum Extent Practicable (MEP) process as described in .

### Compliance Worksheet Tab

The Compliance worksheet summarizes the stormwater retention and treatment results for each DA as well as the whole site. For all sites, in order to comply with the stormwater management requirements, each DA must indicate that the vehicular access areas volume has been addressed. In the MS4, each DA must either indicate that 50 percent of the SWRv has been retained, or that there are —0nches of remaining volume to treat 50% of the SWRv. Key values for each drainage area are described on this worksheet, with Site Compliance and the Public Right-of-Way summarized at the bottom.

**Cell B106** indicates the Total Volume Retained on-site. **Cell B108** (cubic feet) and **cell B109** (gallons) indicate the remaining retention volume (if any) to meet the SWRv. If the SWRv has not been fully met, **cell B115** indicates the required Off-site Retention Volume (Offv). The Offv may be addressed through the use of Stormwater Retention Credits (SRCs) and/or payment of an in-lieu fee. If the SWRv has been exceeded, **cell B114** indicates the volume that may be available for SRCs

This sheet also summarizes the stormwater retention results from the Public right-of-way (ROW) sheet. **Cell B124** indicates the Total Volume Retained on site. **Cells B125** and **B126** show the remaining retention volume (if any) in cubic feet and gallons, respectively. **Cells B131–134** show the remaining treatment volume (if any) to meet SWRv and WQTV requirements.

### Channel and Flood Protection

This sheet assists with calculation of Adjusted Curve Numbers that can be used to calculate peak flows associated with the 2-year storm, 15-year storm, or other storm events.

1. Indicate the appropriate depths for the 1-year, 2-year, and 100-year 24-hour storms (or other storms as needed) on **line 5**.
2. Each cover type is associated with a Natural Resource Conservation Service (NRCS) curve number. **Cells D34–38** show the curve number for D.A. 1. Using these curve numbers (or other curve numbers if appropriate), a weighted curve number and the total runoff volume for D.A. 1 is calculated (**cell E38**).
3. **Line 41** calculates the runoff volume without regard to the BMPs employed in D.A. 1. **Line 42** subtracts the storage volume provided by the BMPs in D.A. 1 from these totals.
4. The spreadsheet then determines the curve number that results in the calculated runoff volume with the BMPs. This Adjusted Curve Number is reported on **line 43**.
5. These steps are repeated for Drainage Areas B–E.

### Weighted Curve Number

$$CN = [(A_N \times 70) + (A_C \times 74) + (A_I \times 98)]/SA$$

where:

$CN$	=	weighted curve number
$A_N$	=	area of post-development natural cover (ft <sup>2</sup> )
$A_C$	=	area of post-development compacted cover (ft <sup>2</sup> )
$A_I$	=	area of post-development impervious cover (ft <sup>2</sup> )
$SA$	=	total site area (ft <sup>2</sup> )

### Potential Abstraction

$$S = 1000/(CN-10)$$

where:

$S$	=	potential abstraction (in.)
$CN$	=	weighted curve number

### Runoff Volume with no Retention

$$Q = (P - 0.2 \times S)^2 / (P + 0.8 \times S)$$

where:

$Q$	=	runoff volume with no BMPs (in.)
$P$	=	precipitation depth for a given 24-hour storm (in.)
$S$	=	potential abstraction (in.)



### Runoff Volume with BMPs

$$Q_{BMP} = Q - Cv(da) \times 12/SA$$

where:

- $Q_{BMP}$  = runoff volume with BMPs (in.)
- $Q$  = runoff volume with no BMPs (in.)
- $Cv(da)$  = total storage volume provided by BMPs for the drainage area (ft<sup>3</sup>)
- 3630 = unit adjustment factor, cubic feet to acre-inches
- $DA$  = site area (ac)

### Adjusted Curve Number

The adjusted curve number is calculated using a lookup table of curve number and runoff volumes so that:

$$CN_{adjusted, so} (P - 0.2 \times S_{adjusted}) \times 2 / (P + 0.8 \times S_{adjusted}) = Q_{BMP}$$

$$S_{adjusted} = 1000 / (CN_{adjusted} - 10)$$

where:

- $CN_{adjusted}$  = adjusted curve number that will create a runoff volume equal to the drainage area runoff volume including BMPs
- $P$  = precipitation depth for a given 24-hour storm (in.)
- $S_{adjusted}$  = adjusted potential abstraction based upon adjusted curve number (in.)
- $Q_{BMP}$  = runoff volume with BMPs (in.)

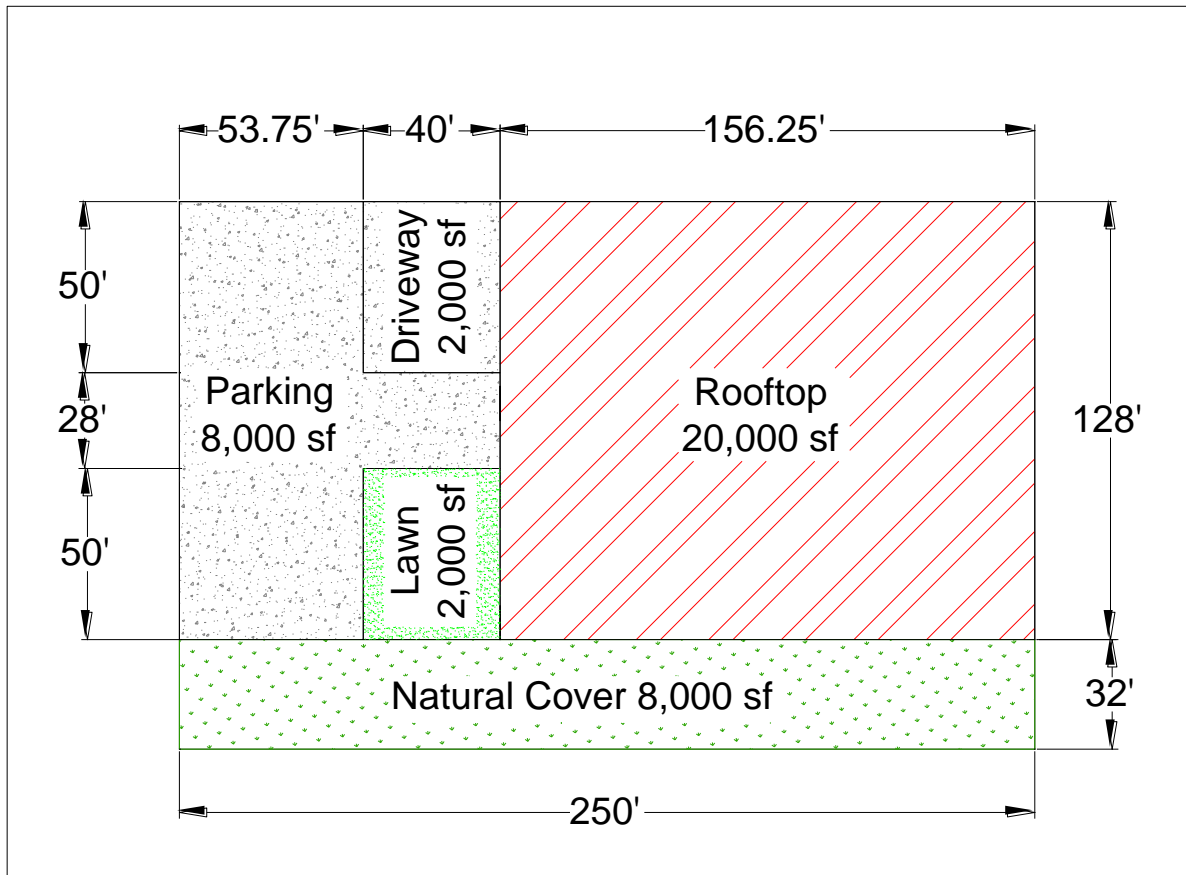
## A.3 Design Examples

### Design Example 1

#### **Step 1: Determine Design Criteria.**

Design Example 1 includes the following site characteristics:

Site Name	Anacostia Offices
Total Site Area	40,000 ft <sup>2</sup>
Natural Cover Area	8,000 ft <sup>2</sup>
Compacted Cover	2,000 ft <sup>2</sup>
Impervious Cover	30,000 ft <sup>2</sup>
Vehicular Access Areas	10,000 ft <sup>2</sup>
Is site located within the AWDZ?	No
Is site located within the MS4?	No
What type of activity is site undergoing?	Major Land Disturbing



**Step 2: Input Design Criteria to Determine the Retention and Treatment Requirements.**

The General Retention Compliance Calculator will calculate a Stormwater Retention Volume (SWR<sub>v</sub>), once the natural cover, compacted cover, and impervious cover areas are put into cells **D22-D25** on the Site Data sheet.

Based on the design criteria above, Anacostia Offices has the following requirements:

$$SWR_v \times \text{cell D37} = 2,900 \text{ ft}^3$$

**Step 3: Identify Site Constraints and BMP restrictions**

Key considerations for Anacostia Offices include the following:

- Site soils are contaminated, so infiltration is not allowed, and impermeable liners will be required for most BMPs.
- The commercial land use means that most BMPs are otherwise acceptable.

**Step 4: Select BMPs to Meet the Retention and Treatment Requirements.**

While there are numerous options for treatment of this site, two BMPs were selected: rainwater harvesting (R1) for the rooftop and bioretention (B1) for any remaining rooftop runoff and the rest of the site. Since the site is contaminated, a liner is required and the enhanced bioretention option is not available.

The site will ultimately have one outlet point, and the selected treatment train is relatively simple, so the calculations can be performed on one Drainage Area tab – D.A. 1. Therefore, all of the same values from the Site Data tab for the various cover types (plus the vehicle access area) should be put into **cells B6-10** on the D.A.1 tab.

The first BMP selected is rainwater harvesting for runoff from the rooftop. The Cistern Design spreadsheet should be used to determine the cistern size and the associated retention value. In the Cistern Design Spreadsheet 20,000 square feet should be put in as the Contributing Drainage Area (CDA) (**cell L7**). For utilization of the rainwater, flushing toilets/urinals is selected as the use, and the appropriate values are entered. In this case, 500 people will use the building per day (**cell L21**), Monday through Friday (**cells L30 and L32**), 8 hours per day (**cell L34**). On the Results – Retention Value sheet, the retention values are given for various tank sizes. The tables and graphs show that a 30,000 gallon underground tank (or series of tanks) would meet much of the demand and have a very high retention value—94 percent.

The next step is to return to the D.A. 1 tab and input the 20,000-square foot CDA into **cell D25** for rainwater harvesting and input the efficiency (94%) into **cell K25**. The result is that 2,530 cubic feet of runoff are retained and 162 cubic feet remain. Since Standard Bioretention will be the next BMP in the series, it should be selected from the pull-down menu in **cell S25**. The remaining runoff volume will then be directed to this BMP.

In addition to the overflow from the rainwater harvesting BMP, the bioretention area will receive runoff from the rest of the site. Initially, these land uses can be input into **cells B39–D40**. However, the surface area of the bioretention area must be accounted for as well. Through trial and error, it was determined that a 1,000-square-foot bioretention area would be sufficient to meet the retention requirement. This area will be taken from the compacted cover area and will need to be changed on the Site Data Tab as well as at the top of DA. 1. Compacted cover will now be 1,000 square feet, and BMP will be 1,000 square feet. The 8,000 square feet of natural cover will remain. Impervious cover directed to the bioretention area will be 10,000 square feet (the remaining impervious area after 20,000 square feet was removed for rainwater harvesting). Since this 10,000 square feet is made up of driveway and parking area, it is all classified as vehicular access area, so 10,000 should be put into **cell F39** as well.

The vehicular access retention/treatment requirement is 475 cubic feet (**cell G39**), and the total volume directed to the bioretention area, including the “overflow” from the rainwater harvesting BMP, will be 1,677 cubic feet (**cell M39**) is more than sufficient to address the vehicular access volume and. Inputting 800 cubic feet for the storage volume in the spreadsheet (**cell O39**) leads to an exceedence of 300 gallons for the SWRv (**cell Q69**). This information is also summarized on the Compliance worksheet tab.

**Step 5: Size the BMPs According to the Design Equations.**

The size of the rainwater-harvesting cistern was already determined to be 30,000 gallons, although additional volume may be necessary for dead storage for a pump, and/or freeboard.

To meet the bioretention criteria, the bioretention area is sized with 1.5 feet of filter media, 0.75 feet of gravel, and a 0.5-foot ponding depth. The bioretention cell sizing goal is 800 cubic feet.

**Step 5.1: Check the Filter Media Depth.**

Ensure that the filter media depth does not exceed the maximum in Table 3.21. The ratio of the surface area of the BMP (1,000 ft<sup>2</sup>) to the contributing drainage area (32,000 ft<sup>2</sup>) is 3.1%. The R<sub>v</sub> for the contributing drainage area to the bioretention practice is 0.93. The maximum filter media depth allowed is 5.0 feet. As the bioretention was sized with 1.5 feet of filter media, it passes this check.

**Table 3.21 Determining Maximum Filter Media Depth (feet)**

SA:CDA (%)	R <sub>v</sub> CDA								
	0.25	0.3	0.40	0.50	0.60	0.70	0.80	0.90	0.95
0.5	6.0	6.0	6.0	6.0	6.0	6.0	6.0	6.0	6.0
1.0	5.0	5.5	6.0	6.0	6.0	6.0	6.0	6.0	6.0
1.5	3.5	4.0	5.0	6.0	6.0	6.0	6.0	6.0	6.0
2.0	2.5	3.0	4.0	5.0	5.5	6.0	6.0	6.0	6.0
2.5	2.0	2.5	3.5	4.0	4.5	5.0	5.5	6.0	6.0
3.0	1.5	2.0	3.0	3.5	4.0	4.5	5.0	5.5	5.5
3.5	1.5	1.5	2.5	3.0	3.5	4.0	4.5	5.0	5.0
4.0	1.5	1.5	2.0	2.5	3.0	3.5	4.0	4.5	4.5
4.5	1.5	1.5	2.0	2.5	3.0	3.5	3.5	4.0	4.5
5.0	1.5	1.5	1.5	2.0	2.5	3.0	3.5	4.0	4.0
5.5	1.5	1.5	1.5	2.0	2.5	2.5	3.0	3.5	3.5
6.0	1.5	1.5	1.5	1.5	2.0	2.5	3.0	3.0	3.5
6.5	1.5	1.5	1.5	1.5	2.0	2.5	2.5	3.0	3.0
7.0	1.5	1.5	1.5	1.5	1.5	2.0	2.5	3.0	3.0
7.5	1.5	1.5	1.5	1.5	1.5	2.0	2.5	2.5	2.5
8.0	1.5	1.5	1.5	1.5	1.5	2.0	2.0	2.5	2.5
8.5	1.5	1.5	1.5	1.5	1.5	1.5	2.0	2.0	2.5
9.0	1.5	1.5	1.5	1.5	1.5	1.5	2.0	2.0	2.0
9.5	1.5	1.5	1.5	1.5	1.5	1.5	1.5	2.0	2.0
10.0	1.5	1.5	1.5	1.5	1.5	1.5	1.5	2.0	2.0

**Step 5.2: Determine Storage Volume.**

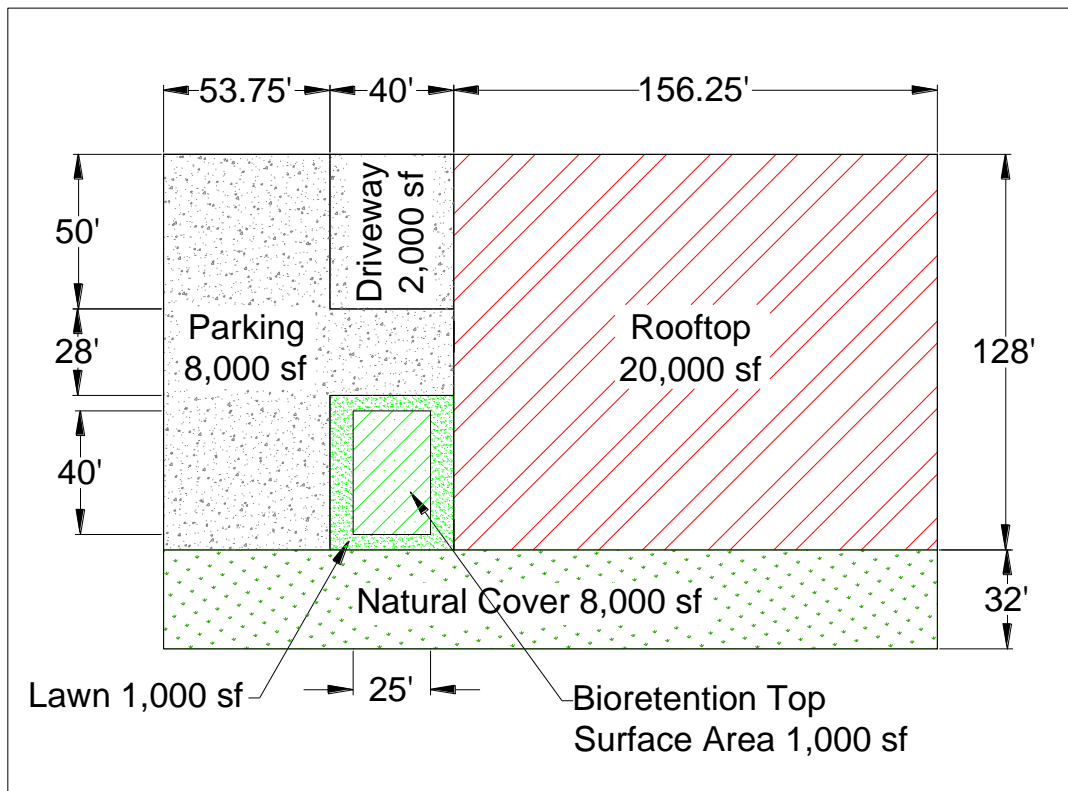
**Equation 3.5**

$$S_v = SA_{bottom} \times [(d_{media} \times \eta_{media}) + (d_{gravel} \times \eta_{gravel})] + (SA_{average} \times d_{ponding})$$

where:

- $S_v$  = total storage volume of bioretention (ft<sup>3</sup>)
- $SA_{bottom}$  = bottom surface area of bioretention (ft<sup>2</sup>)
- $d_{media}$  = depth of the filter media (ft)
- $\eta_{media}$  = effective porosity of the filter media (typically 0.25)
- $d_{gravel}$  = depth of the underdrain and underground storage gravel layer(ft)
- $\eta_{gravel}$  = effective porosity of the gravel layer (typically 0.4)
- $SA_{average}$  = the average surface area of the bioretention (ft<sup>2</sup>)  
(typically =  $\frac{1}{2} \times$  (top area +  $SA_{bottom}$  area))
- $d_{ponding}$  = the maximum ponding depth of the bioretention (ft)

Solving Equation 3.5 often requires an iterative approach to determine the most appropriate bottom surface area and average surface area to achieve the desired  $S_v$ . In this case, a bioretention with a 40 foot by 25 foot top area and 3:1 side slopes will provide a  $SA_{top}$  of 1,000 square feet, a  $SA_{bottom}$  of 814 square feet, a  $SA_{average}$  of 907 square feet, and achieve a  $S_v$  of 1,003 cubic feet.



**Step 6: Design Assumptions and Requirements**

Key assumptions and requirements for this site include:

- Based upon the above design, the rainwater harvesting cistern will be 30,000 gallons and the bioretention cell will require at least 1,000 square feet of surface area. The designer would need to ensure that space would be available for these BMPs on the site.
- The contributing drainage area for traditional bioretention must be 2.5 acres or less and this site is less than 1 acre.
- The required head for the above design will be 25 feet, including ponding depth (9 inches), mulch (3 inches), filter media (18 inches), choking layer (about 3 inches), and gravel layer (about 9 inches). (See Figure 3.18). The outlet for the underdrain must be at least this deep.
- The water table must be at least 2 feet below the underdrain, or 5.5 feet below the surface. According to the Soil Survey, Beltsville soils have a 1.5- to 2-foot depth to seasonally high groundwater table, Croom soils have greater than a 5-foot depth, and Sassafra soils have a 4-foot depth. On-site soil investigations will be needed to determine if the 5.5-foot depth to the groundwater table can be met on this site.
- Due to soil contamination and the bioretention area's proximity to the building (less than 10 feet), an impermeable liner is required.

Since all of these assumptions and requirements can be met in this design example (pending groundwater table investigations), this step is complete.

**Step 7: Use the Adjusted Curve Number to Address Peak Flow Requirements.**

On the Channel and Flood Protection tab, enter values for C soils in **cells D34, D36, and D38** (70 for natural areas, 74 for turf, and 98 for impervious cover, respectively). The original site curve number of 92 is reduced for the 2-year, 15-year, and 100-year storms to 79, 82, and 83, respectively, by the retention provided by the cistern and bioretention cell. These values can be used to help determine detention requirements for this site.

**Step 8: Determine Detention Requirements.**

Detention is required to reduce the peak discharge rate from the 2-year storm event to the pre-development (meadow conditions or better) peak discharge rate and to reduce the peak discharge rate from the 15-year storm event to the pre-project peak discharge rate. Appendix H includes details on the procedure for calculating the detention volume. In this example, the proposed impervious cover and the proposed runoff curve number is less than the pre-project conditions, so detention for the 15-year storm is not required. Detention for the 2-year storm will be required.

The peak inflow ( $qi_2$ ) and the peak outflow ( $qo_2$ ) can be calculated using the WinTR-55 Small Watershed Hydrology program, the area of the site, the time of concentration ( $T_c$ , assumed to be 10 minutes), and the curve numbers. The reduced curve of 79, determined above, generates a  $qi_2$  of 1.61 cubic feet per second (cfs). The curve number for meadow in good condition, 71, generates a  $qo_2$  of 1.07 cfs.

The ratio of 1.07 cfs to 1.61 cfs equals 0.63. Using Figure H.1, the ratio of storage volume (Vs2) to runoff volume (Vr2) is 0.22.

The runoff volume (Vr2) determined from the General Retention Compliance Calculator spreadsheet is 1.33 inches, which equates to 4,333 cubic feet. Using the calculated ratio of Vs2/Vr2, the storage volume required for the site (Vs2) is 1,020 cubic feet.

With appropriate orifice design to ensure that outflows are properly restricted, this detention volume can be incorporated below the proposed bioretention area or located elsewhere on the site as a standalone detention practice.

## Design Example 2

### **Step 1: Determine Design Criteria.**

Design Example 2 includes the following proposed design criteria:

Site Name	Downtown Multi-Story Renovation
Total Site Area	15,000 ft <sup>2</sup>
Natural Cover Area	0 ft <sup>2</sup>
Compacted Cover	0 ft <sup>2</sup>
Impervious Cover (Rooftop)	15,000 ft <sup>2</sup>
Is site located within the AWDZ?	No
Is site located within the MS4?	Yes
What type of activity is the site undergoing?	Major Substantial Improvement

### **Step 2: Input Design Criteria to Determine the Retention and Treatment Requirements.**

The Compliance Calculator Spreadsheet will calculate a Stormwater Retention Volume (SWRv), once the above values are put into the Site Data sheet.

Based on the design criteria above, the Multi-Story Renovation project is required to treat 0.8 inches of rainfall for the SWRv:

$$\text{SWRv} \times \text{cell D37} = 950 \text{ ft}^3$$

### **Step 3: Identify Site Constraints and BMP Restrictions.**

Key considerations for the Multi-Story Renovation project include the following:

- Since this is a rooftop-only site, very few treatment options are available.
- As a renovation, the structure of the existing roof will be a factor for any rooftop practice.

### **Step 4: Select BMPs to Meet the Retention and Treatment Requirements.**

As an initial estimate 75 percent of the rooftop is proposed to be converted to a green roof, with the remaining 25 percent draining to it. Therefore, the land use values need to be changed to

account for the green roof: 3,750 square feet should be entered as rooftop in **cell D24** on the Site Data sheet, and 11,250 square feet should be entered in **cell D25** as **–BMP.**” As there will be only one drainage area for the site, these same values should be entered into **cells B8** and **B10** on sheet D.A. 1. and as the Green Roof drainage area (**cells D23** and **D24**).

The goal of this design is to capture the entire retention volume (950 ft<sup>3</sup>) in the Green Roof. This can be shown on the spreadsheet by entering 950 cubic feet in **cell O23** on sheet D.A. A. **Cell Q69** shows that the SWRv has been met for the site. This information is also summarized on the Compliance worksheet tab.

**Step 5: Size the BMPs According to the Design Equations.**

The green roof needs to be sized according to Equation 3.1. Note: Since green roofs are typically manufactured systems, several of the parameters, such as the drainage layer depth and porosity of all layers, need to be provided by the manufacturer. The values for the roof used in this design are provided in the variable descriptions below Equation 3.1 (with each layer illustrated in Figure 3.1).

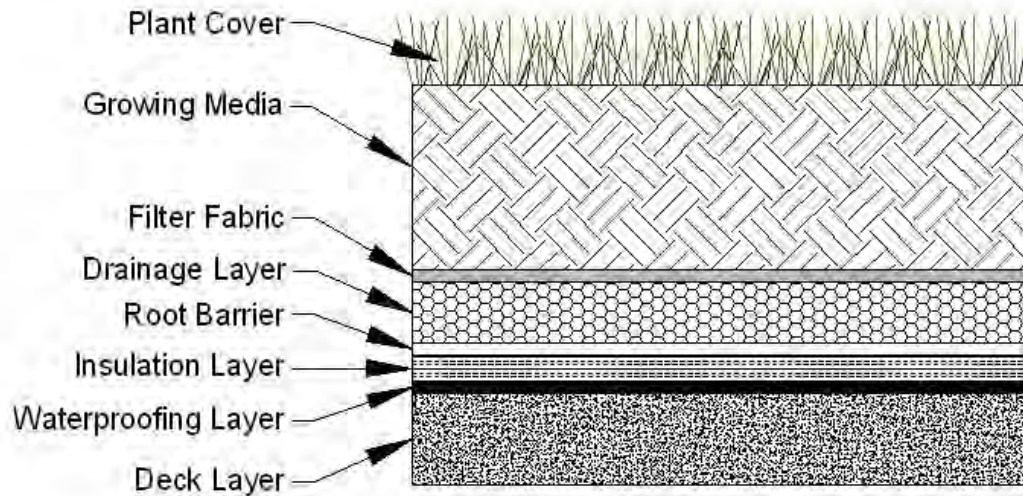
**Equation 3.1 Storage Volume for Green Roofs**

$$Sv = SA \times [(d \times \eta_1) + (DL \times \eta_2)] / 12$$

where:

- Sv* = storage volume (ft<sup>3</sup>) (goal is 950 ft<sup>3</sup>)
- SA* = green roof area (ft<sup>2</sup>) (need to determine)
- D* = media depth (in.) (6 in.)
- η<sub>1</sub>* = media porosity (0.25)
- DL* = drainage layer depth (in.) (1 in.)
- η<sub>2</sub>* = drainage layer porosity (0.4)





**Figure 3.1 Typical layers for a green roof.**

Rearranging Equation 3.1 to find the minimum required surface area:

$$SA = Sv / [(d \times \eta_1) + (DL \times \eta_2)] \times 12$$

or:

$$SA = 950 / (6 \times 0.25 + 1 \times 0.4) \times 12$$

$$SA = 6,000 \text{ ft}^2$$

Therefore, the green roof must be sized to be at least 6,000 square feet, given the proposed depths. The original assumption was that an 11,250-square-foot roof would be used. Since a smaller roof is feasible, the drainage areas in the spreadsheet may be revised accordingly. Note: The drainage area to the green roof is only 25 percent larger than the green roof itself, so the maximum additional drainage area to a 6,000-square-foot roof is 1,500 square feet. Alternatively, the larger roof may be utilized, and the increased storage volume can be used to reduce peak flow volume requirements (see Step 8) or sold as Stormwater Retention Credits.

**Step 6: Check Design Assumptions and Requirements.**

Key assumptions and requirements for this site include:

- A structural analysis of the building is needed to determine that the green roof can be supported by the existing structure.
- Ensure that there is sufficient space on the rooftop (allowing for structures such as vents, steep areas of the roof, and other panels). In this case, the minimum roof area of 6,000 square feet is less than half of the entire roof area and most roofs can accommodate this area.

- At least 1,500 square feet of the rooftop not covered by green roof needs to be designed so that it drains to the green roof without damaging it.

Since all of these assumptions and requirements can be met in this design example, this step is complete.

**Step 7: Use the Adjusted Curve Number to Address Peak Flow Requirements.**

The initial curve number for this site is 98, but retention provided by the green roof changes this number. The Channel and Flood Protection tab notes the reduced curve numbers for the 2-year, 15-year, and 100-year storms: 90, 91, and 92, respectively. These curve numbers can be used to help determine detention requirements for this site.

**Step 8: Determine Detention Requirements.**

Detention is required to reduce the peak discharge rate from the 2-year-storm event to the pre-development (meadow conditions or better) peak discharge rate and to reduce the peak discharge rate from the 15-year storm event to the pre-project peak discharge rate. Appendix H includes details on the procedure for calculating the detention volume. In this example, since the proposed land cover is the same as the pre-project conditions, detention is not required for the 15-year storm. However, detention is required for the 2-year storm.

The peak inflow,  $q_{i2}$  and the peak outflow,  $q_{o2}$  can be calculated using the WinTR-55 Small Watershed Hydrology program, the area of the site, the time of concentration ( $T_c$ , assumed to be 10 minutes), and the curve numbers. The reduced curve of 90, determined above, generates a  $q_{i2}$  of 1.00 cubic foot per second (cfs). The curve number for meadow in good condition, 71, generates a  $q_{o2}$  of 0.39 cfs.

The ratio of 0.39 cfs to 1.00 cfs equals 0.39. Using Figure H.1, this equates to a ratio of storage volume ( $V_{s2}$ ) to runoff volume ( $V_{r2}$ ) of 0.33.

The runoff volume ( $V_{r2}$ ) determined in the Compliance Calculator spreadsheet is 2.21 inches, which equates to 2,763 cubic feet. Using the calculated ratio of  $V_{s2}/V_{r2}$ , the storage volume required for the site ( $V_{s2}$ ) is 912 cubic feet.

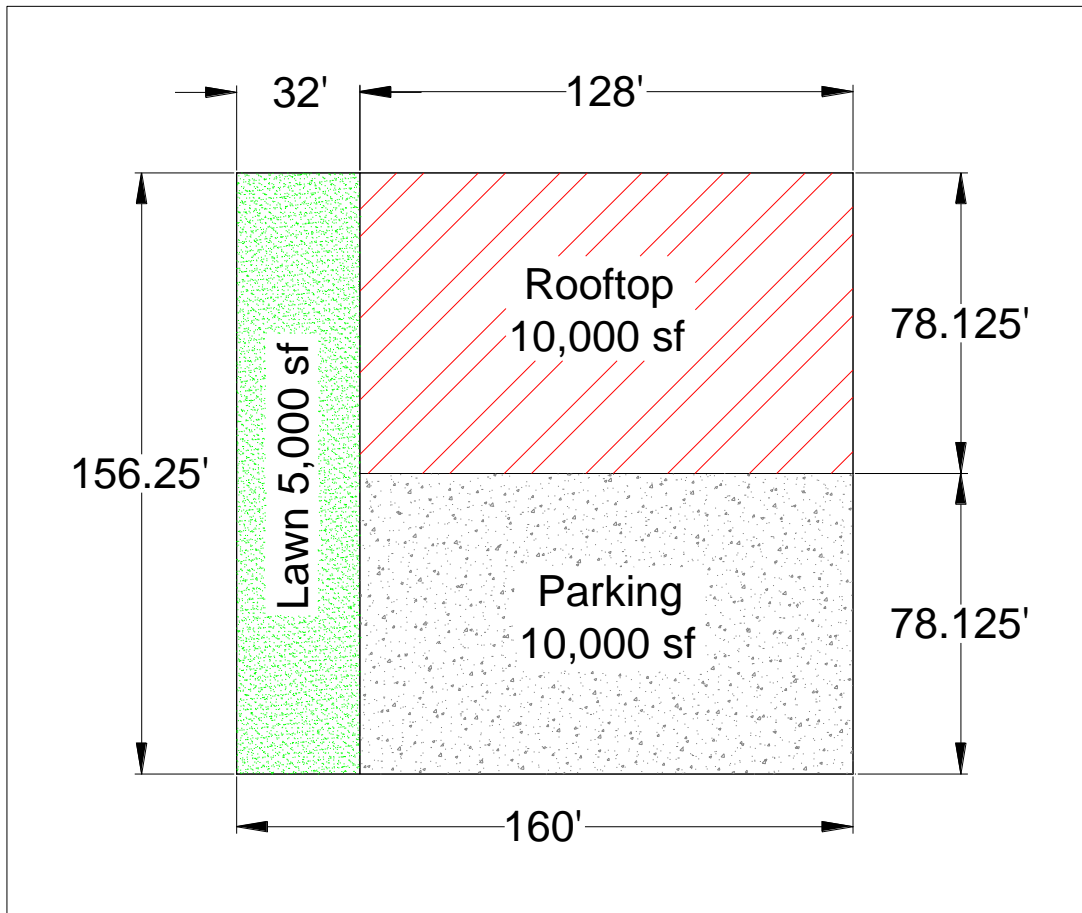
Rooftop Storage (see Appendix I) may be the most cost effective method for achieving this detention volume in this example.

**Design Example 3**

**Step 1: Determine Design Criteria.**

Design Example 3 includes the following proposed design criteria:

Site Name	Ward 5 Low-Rise Commercial
Total Site Area	25,000 ft <sup>2</sup>
Natural Cover Area	0 ft <sup>2</sup>
Compacted Cover	5,000 ft <sup>2</sup>
Impervious Cover	20,000 ft <sup>2</sup>
Vehicular Access Areas	10,000 ft <sup>2</sup>
Is site located in the AWDZ?	No
Is site located within the MS4?	Yes
What type of activity is site undergoing?	Major Land Disturbing



**Step 2: Input Design Criteria to Determine the Retention and Treatment Requirements.**

The Compliance Calculator Spreadsheet will calculate a Stormwater Retention Volume (SWR<sub>v</sub>), once the natural cover, compacted cover, and impervious cover areas are put into **cells D22–D25** on the Site Data sheet.

Based on the design criteria above, the project has the following requirement:

$$SWR_v \times \text{cellD37} = 2,025 \text{ ft}^3$$

**Step 3: Identify Site Constraints and BMP restrictions.**

Key considerations for the project include the following:

- Only a small portion of the compacted cover is available for potential BMPs.
- The Multi-Family Residential site is not restrictive of BMP options.
- The relatively permeable Sunnyside-Sassafras-Muirkirk-Christiana soils on this site allow for infiltration into site soils. However, it is not likely that infiltration rates will be greater than 2 inches per hour.

**Step 4: Select BMPs to Meet the Retention and Treatment Requirements.**

An enhanced bioretention with no underdrain is chosen for this site, primarily to minimize cost. Several other options, such as permeable pavers, would have been acceptable at this site.

The site will ultimately have one outlet point, with only one BMP, so the calculations can be performed on one Drainage Area tab—D.A. 1. Therefore, all of the same values from the Site Data tab for the various cover types (plus the vehicle access area) should be put into **cells B6–B10** on the D.A. 1 sheet.

It is assumed that the entire site will be directed to the bioretention area, so the same values from the top of the DAA sheet may be input into **cells B37–F38** (including the 10,000 square feet of vehicle access area in cell F38). However, the surface area of the bioretention area must be accounted for as well. It was determined that only 1,000 square feet of compacted cover would be available for a bioretention area. This area will be taken from the compacted cover area, and will need to be changed on the Site Data Tab as well as the top of D.A. 1. Compacted cover will now be 4,000 square feet, and “BMP” will be 1,000 square feet. The rooftop and parking areas will not change. This approach will lead to a total volume of 2,968 cubic feet directed to the BMP.

Since enhanced bioretention receives 100 percent retention value, the required storage volume to meet the  $SWR_v$  is 2,095 cubic feet (this is the required  $SWR_v$  after changes in land use were made to account for the bioretention surface area). However, the 1,000 square feet available will not be sufficient to provide the entire required storage volume. Through trial and error (see Step 5 below) it was determined that the maximum storage volume is 1,077 cubic feet. This value can be input into **cell O37**. **Cell P68** indicates that there is still 1,018 cubic feet, or 7,615 gallons (**cell P69**) remaining. This volume will have to be met through the purchase or generation of Stormwater Retention Credits (SRCs) (see Chapter 7 and Step 9 below).

**Step 5: Size the BMPs According to the Design Equations.**

Assume a filter media depth of 2 feet, a gravel depth of 0.75 feet, and a ponding depth of 1 foot.

**Step 5.1: Check the Filter Media Depth.**

Ensure that the filter media depth does not exceed the maximum in Table 3.21. The ratio of the surface area of the bioretention (1,000 ft<sup>2</sup>) to the contributing drainage area (25,000 ft<sup>2</sup>) is 4%.

The  $R_v$  was previously determined to be 0.95. The maximum filter media depth allowed is 4.5 feet. As the bioretention was sized with 2 feet of filter media, it passes this check.

**Table 3.21 Determining Maximum Filter Media Depth (feet)**

SA:CDA (%)	$R_{V_{CDA}}$								
	0.25	0.3	0.40	0.50	0.60	0.70	0.80	0.90	0.95
0.5	6.0	6.0	6.0	6.0	6.0	6.0	6.0	6.0	6.0
1.0	5.0	5.5	6.0	6.0	6.0	6.0	6.0	6.0	6.0
1.5	3.5	4.0	5.0	6.0	6.0	6.0	6.0	6.0	6.0
2.0	2.5	3.0	4.0	5.0	5.5	6.0	6.0	6.0	6.0
2.5	2.0	2.5	3.5	4.0	4.5	5.0	5.5	6.0	6.0
3.0	1.5	2.0	3.0	3.5	4.0	4.5	5.0	5.5	5.5
3.5	1.5	1.5	2.5	3.0	3.5	4.0	4.5	5.0	5.0
4.0	1.5	1.5	2.0	2.5	3.0	3.5	4.0	4.5	4.5
4.5	1.5	1.5	2.0	2.5	3.0	3.5	3.5	4.0	4.5
5.0	1.5	1.5	1.5	2.0	2.5	3.0	3.5	4.0	4.0
5.5	1.5	1.5	1.5	2.0	2.5	2.5	3.0	3.5	3.5
6.0	1.5	1.5	1.5	1.5	2.0	2.5	3.0	3.0	3.5
6.5	1.5	1.5	1.5	1.5	2.0	2.5	2.5	3.0	3.0
7.0	1.5	1.5	1.5	1.5	1.5	2.0	2.5	3.0	3.0
7.5	1.5	1.5	1.5	1.5	1.5	2.0	2.5	2.5	2.5
8.0	1.5	1.5	1.5	1.5	1.5	2.0	2.0	2.5	2.5
8.5	1.5	1.5	1.5	1.5	1.5	1.5	2.0	2.0	2.5
9.0	1.5	1.5	1.5	1.5	1.5	1.5	2.0	2.0	2.0
9.5	1.5	1.5	1.5	1.5	1.5	1.5	1.5	2.0	2.0
10.0	1.5	1.5	1.5	1.5	1.5	1.5	1.5	2.0	2.0

**Step 5.2: Determine Storage Volume.**

**Equation 3.5**

$$S_v = SA_{bottom} \times [(d_{media} \times \eta_{media}) + (d_{gravel} \times \eta_{gravel})] + (SA_{average} \times d_{ponding})$$

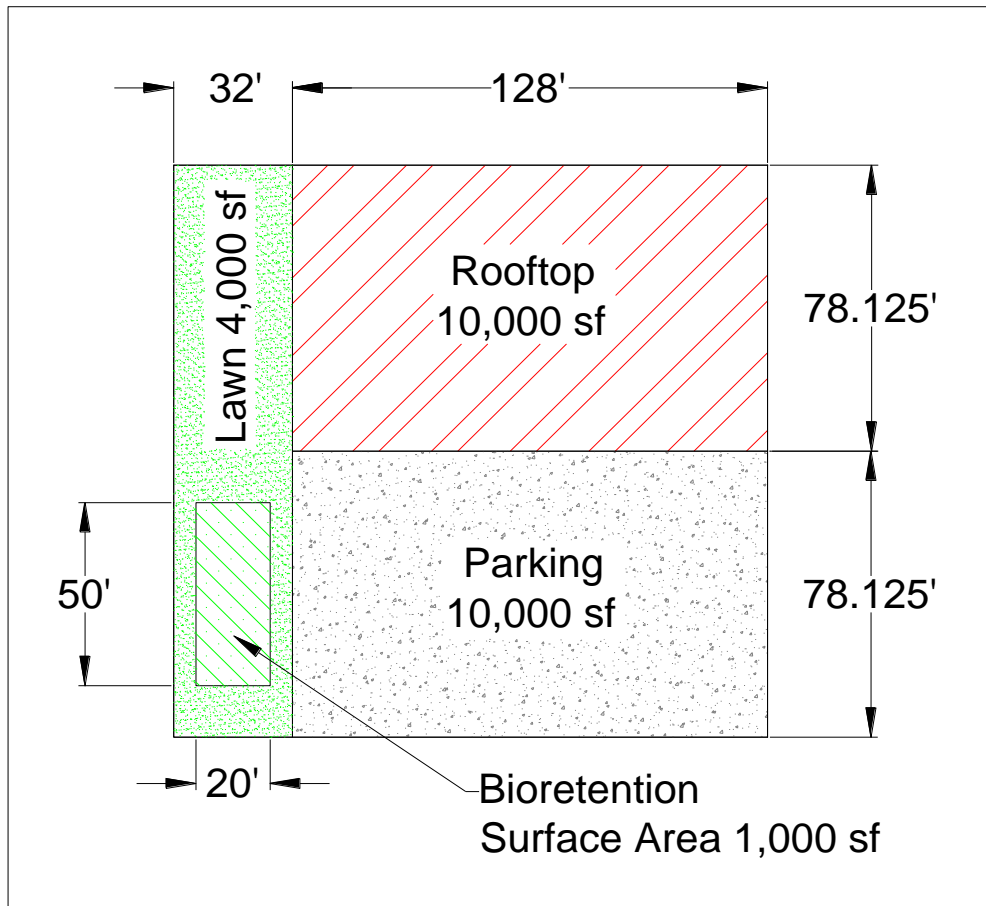
where:

- $S_v$  = total storage volume of bioretention (ft<sup>3</sup>)
- $SA_{bottom}$  = bottom surface area of bioretention (ft<sup>2</sup>)
- $d_{media}$  = depth of the filter media (ft)
- $\eta_{media}$  = effective porosity of the filter media (typically 0.25)
- $d_{gravel}$  = depth of the underdrain and underground storage gravel layer(ft)
- $\eta_{gravel}$  = effective porosity of the gravel layer (typically 0.4)
- $SA_{average}$  = the average surface area of the bioretention (ft<sup>2</sup>)

$$d_{ponding} = \frac{(top\ area + SA_{bottom})}{2} \quad (\text{typically} = 1/2 \times (\text{top area} + SA_{bottom} \text{ area}))$$

= the maximum ponding depth of the bioretention (ft)

Solving Equation 3.5 often requires an iterative approach to determine the most appropriate bottom surface area and average surface area to achieve the desired  $S_v$ . In this case, a long, narrow practice with a 50 foot by 20 foot top area and 3:1 side slopes was all that would fit on the site. This configuration will provide a  $SA_{top}$  of 1,000 square feet, a  $SA_{bottom}$  of 616 square feet, a  $SA_{average}$  of 808 square feet, and will achieve an  $S_v$  of 1,301 cubic feet.



**Step 6: Check Design Assumptions and Requirements.**

Key assumptions and requirements for this site include:

- The design will need at least 1,000 square feet of surface area. The designer would need to ensure that this area is available.
- Contributing drainage area for traditional bioretention must be 2.5 acres or less, and this site has a total drainage area of less than 0.5 acres.
- Head requirements are not likely to be an issue, since this is an infiltration design.

- The water table must be at least 2 feet below the bottom of the bioretention, or 4.25 feet below the surface.
- The measured permeability of the underlying soils must be at least 0.5 inches/hour.
- Additional SRCs will need to be generated or purchased off-site.

Since all of these assumptions and requirements can be met (pending groundwater table and infiltration rate investigations) in this design example, this step is complete.

**Step 7: Use the Adjusted Curve Number to Address Peak Flow Requirements.**

On the Channel and Flood Protection tab, enter values for B soils in cells **D34**, **D36**, and **D38** (55 for natural areas, 61 for turf, and 98 for impervious cover, respectively). The original site curve number of 92 is reduced for the 2-year, 15-year, and 100-year storms to 86, 87, and 88, respectively by the retention provided by the bioretention cell. These curve numbers can be used to help determine detention requirements for this site.

**Step 8: Determine Detention Requirements.**

Detention is required to reduce the peak discharge rate from the 2-year storm event to the pre-development (meadow conditions or better) peak discharge rate and to reduce the peak discharge rate from the 15-year storm event to the pre-project peak discharge rate. Appendix H includes details on the procedure for calculating the detention volume. In this example, the proposed impervious cover and the proposed runoff curve number is less than the pre-project conditions, so detention for the 15-year storm is not required. Detention for the 2-year storm will be required.

The peak inflow ( $q_{i2}$ ) and the peak outflow ( $q_{o2}$ ) can be calculated using the WinTR-55 Small Watershed Hydrology program, the area of the site, the time of concentration ( $T_c$ , assumed to be 10 minutes), and the curve numbers. The reduced curve of 86, determined above, generates a  $q_{i2}$  of 1.45 cubic feet per second (cfs). The curve number for meadow in good condition, 58, generates a  $q_{o2}$  of 0.18 cfs.

The ratio of 0.18 cfs to 1.45 cfs equals 0.12. Using Figure H.1, the ratio of storage volume ( $V_{s2}$ ) to runoff volume ( $V_{r2}$ ) is 0.53.

The runoff volume ( $V_{r2}$ ) determined in the Compliance Calculator spreadsheet is 1.84 inches, which equates to 3,833 cubic feet. Using the calculated ratio of  $V_{s2}/V_{r2}$ , the storage volume required for the site ( $V_{s2}$ ) is 2,032 cubic feet.

This detention volume, with appropriate orifice design to ensure that outflows are properly restricted, can be incorporated below the proposed bioretention area or located elsewhere on the site, such as underneath the parking lot as a standalone detention practice.

**Step 9: Identify Stormwater Retention Credits.**

Since the  $SWR_v$  was short of the requirement by 7,615 gallons, 7,615 SRCs will need to be purchased or generated annually for this site to achieve compliance (see Chapter 7 for more details and example calculations).

### Design Example 4

Design Example 4 includes the following proposed design criteria:

Site Name	Green St. and Gold St. Intersection
Total Site Area	13,528 ft <sup>2</sup>
Natural Cover Area	0 ft <sup>2</sup>
Compacted Cover	185 ft <sup>2</sup>
Impervious Cover	13,343 ft <sup>2</sup>

The site in this design example is a street reconstruction project. Since it is located in the public right-of-way (PROW), the maximum extent practicable (MEP) design process applies (see Appendix B).

#### **Step 1: Calculate SWR<sub>v</sub>.**

This intersection includes four stormwater inlets (one at each corner), so it will be divided into four drainage areas. The MEP Verification checklist requires calculation of the contributing drainage area within the limit of disturbance (LOD) as well as calculation of the contributing drainage area outside the LOD.

Drainage Area (DA <sub>1-N</sub> )	Contributing Area (ft <sup>2</sup> )		SWR <sub>v</sub> (gal)	
	within LOD	outside LOD	within LOD	outside LOD
DA1	3,473	1,138	2,371	809
DA2	2,937	987	2,087	701
DA3	5,285	1,747	3,756	1,241
DA4	1,833	1,931	1,303	1,372
<b>DATOTAL</b>	<b>13,528</b>	<b>5,803</b>	<b>9,517</b>	<b>4,123</b>

SWR<sub>v</sub> can be calculated using the Compliance Calculator spreadsheet. In this case, all of the drainage areas were 100 percent impervious, except for DA1, which included 185 square feet of landscaped area within the LOD.

#### **Step 2: Consider Infiltration.**

This step requires looking at infiltration options by identifying constraints to infiltration, such as a high water table, soil contamination, or poor infiltration rates and locating areas that are well suited for infiltration.



In this example, a high water table and soil contamination were not a concern, The soil had only a moderate to low infiltration rate, making an infiltration sump a possibility as part of another BMP (such as enhanced bioretention) but not feasible as a standalone BMP.

**Step 3: Demonstrate full consideration of land-cover conversions and optimum BMP placement.**

Opportunities for BMP placement within and adjacent to the PROW include traffic islands, triangle parks, median islands, cul-de-sacs, paper streets, and traffic calming measures, such as median islands, pedestrian curb extensions, bump outs, chicanes, and turning radius reductions.

As this example is a small intersection project, pedestrian curb extensions are the only feasible location for BMP placement. BMP locations in the pedestrian curb extensions will be possible at three of the four corners of the intersection.

**Step 4: Demonstrate full consideration of opportunities within existing infrastructure.**

This step requires the assessment and documentation of utility locations, storm sewer depths, right-of-way widths, and existing trees to determine potential conflicts.

In this example, the difference in elevation between the storm sewer inlets and the invert of the pipes is approximately 5 feet. Other utilities will constrain the space available for the proposed BMPs but will not eliminate the pedestrian curb extension spaces entirely.

**Step 5: Locate and choose BMPs.**

Although they may be undersized, enhanced bioretention areas will be selected for 3 of the 4 corners in the space available.

Areas for enhanced bioretention are as follows:

Drainage Area (DA <sub>1-N</sub> )	Contributing Area within LOD (ft <sup>2</sup> )	SWRv within LOD (gal)	Available Area for BMP (ft <sup>2</sup> )
DA1	3,473	2,371	72
DA2	2,937	2,087	285
DA3	5,285	3,756	190
DA4	1,833	1,303	0
<b>DATOTAL</b>	<b>13,528</b>	<b>9,517</b>	<b>N/A</b>

**Step 6: Sizing BMPs.**

Each bioretention area will be designed with a similar cross section: vertical side slopes for the ponding area, a ponding depth of 0.75 feet, a filter media depth of 2 feet, and a gravel depth (including the infiltration sump) of 1.25 feet.

The storage volume is determined with Equation 3.5

**Equation 3.5**

$$Sv = SA_{bottom} \times [(d_{media} \times \eta_{media}) + (d_{gravel} \times \eta_{gravel})] + (SA_{average} \times d_{ponding})$$

where:

- $Sv$  = total storage volume of bioretention (ft<sup>3</sup>)
- $SA_{bottom}$  = bottom surface area of bioretention (ft<sup>2</sup>)
- $d_{media}$  = depth of the filter media (ft)
- $\eta_{media}$  = effective porosity of the filter media (typically 0.25)
- $d_{gravel}$  = depth of the underdrain and underground storage gravel layer(ft)
- $\eta_{gravel}$  = effective porosity of the gravel layer (typically 0.4)
- $SA_{average}$  = the average surface area of the bioretention (ft<sup>2</sup>)  
(typically = 1/2 × (top area +  $SA_{bottom}$  area))
- $d_{ponding}$  = the maximum ponding depth of the bioretention (ft).

With the cross section dimensions provided above, Equation 3.5 yields the following results:

Drainage Area (DA <sub>1-N</sub> )	Available Area for BMP (ft <sup>2</sup> )	Sv (gal)	Sv (ft <sup>3</sup> )
DA1	72	942	126
DA2	285	3,731	499
DA3	190	2,487	332
DA4	0	0	0

The table below indicates that there is a retention deficiency for 3 of the 4 drainage areas with the proposed BMPs.

Drainage Area (DA <sub>1-N</sub> )	Regulated SWRv within LOD (gal)	SWRv Achieved (gal)	Retention Deficiency (gal)	Altered Drainage Profile	
				Y	N
DA1	2,371	942	1,429		X
DA2	2,087	3,731	N/A		X
DA3	3,756	2,487	1,269		X
DA4	1,303	-	1,303		X
<b>DATOTAL</b>	<b>9,517</b>	<b>7,160</b>			

If there is a retention volume deficiency, the MEP design process notes that the designer should consider sizing BMPs to manage the comingled volume on-site, and/or revisit Design Steps 1 through 6 to increase land conversion areas and BMP facilities.

In this case, the proposed bioretention areas in DA2 could treat additional volume, but the proposed bioretention areas in DA1 and DA3 are at capacity. At this point, the designer should review steps 1 through 6 to ensure that all opportunities for land conversion and BMP facilities have been maximized. If so, this step is complete.

***Step 7: Drainage Areas Where Zero-Retention BMPs are Installed.***

Drainage areas that do not include a retention BMP will require installation of a water-quality catch basin to treat stormwater runoff. This requirement applies only to DA4 in this example.



# **Appendix B      Maximum Extent Practicable Process for Existing Public Right-of-Way**

## **B.1    Maximum Extent Practicable: Overview**

Maximum extent practicable, or "MEP", is the language of the Clean Water Act that sets the standards to evaluate efforts pursued to achieve pollution reduction to US water bodies. The MEP refers to management practices, control techniques, and system, design and engineering methods for the control of pollutants. It allows for considerations of public health risks, societal concerns, and social benefits, along with the gravity of the problem, and the technical feasibility of solutions.

The MEP is achieved, in part, by selecting and implementing effective structural and nonstructural stormwater best management practices (BMPs) and rejecting ineffective BMPs and replacing them with effective management practices (BMPs). MEP is an iterative standard, which evolves over time as urban runoff management knowledge increases. As such, it must continually be assessed and modified to incorporate improved programs, control measures, BMPs, etc., to attain compliance with water quality standards. Because of this, some end-of-pipe strategies, which were considered to meet the MEP standard ten years ago, are no longer accepted as such. Similarly, in cases where just one BMP may have gained project approval in the past, today there are many cases where multiple BMPs will be required in order to achieve treatment to the MEP.

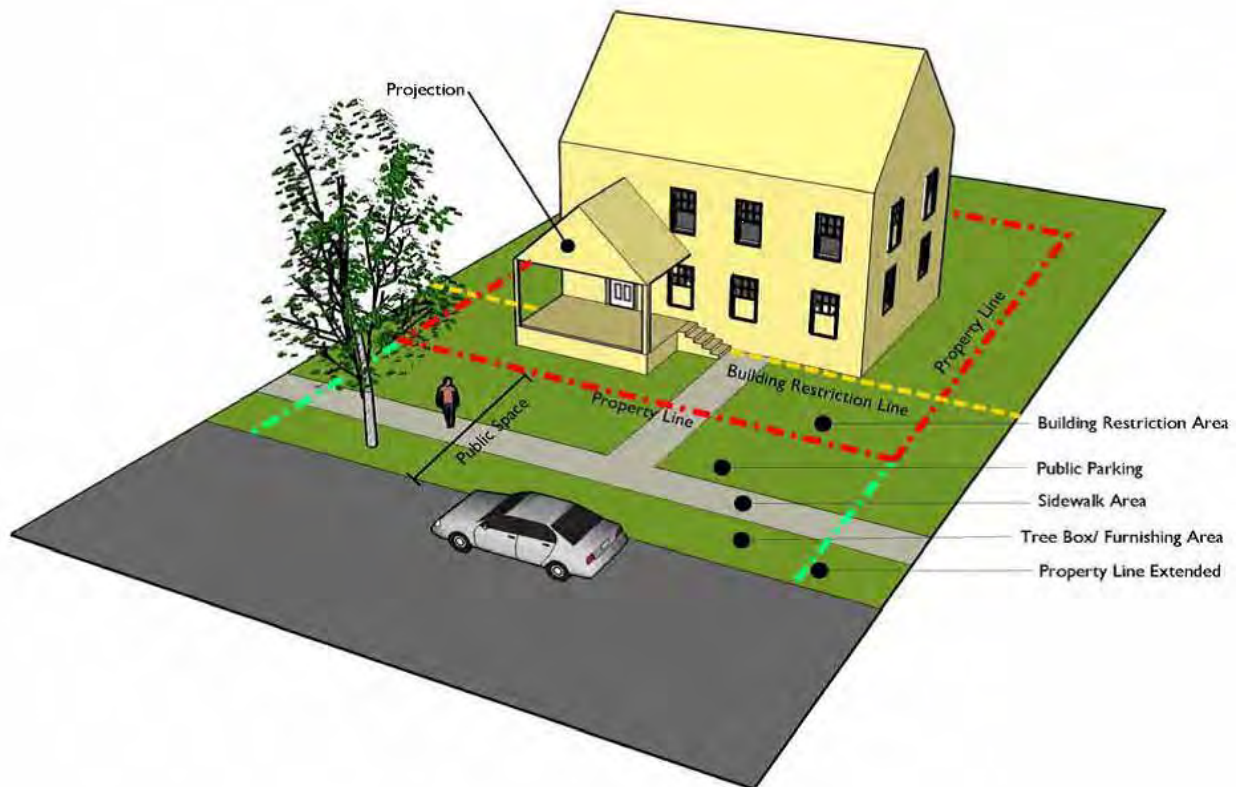
Many jurisdictions have said of the MEP standard that there ~~must~~ be a serious attempt to comply, and practical solutions may not be lightly rejected.” If project applicants implement only a few of the least expensive BMPs, and the regulated volume has not been retained, it is likely that the MEP standard has not been met. If, on the other hand, a project applicant implements all applicable and effective BMPs except those shown to be technically infeasible, then the project applicant would have achieved retention to the MEP.

## **B.2    Public Right-of-Way Projects**

Public right-of-way (PROW) projects are distinct from parcel or lot development within the District of Columbia. These projects are linear in orientation. They may consist of bridges, highways, commercial and residential streets, alleyways, pedestrian walkways, bicycle trails, tunnels and railway tracks. They are owned and operated by the Government. The PROW is defined as the surface and the air space above the surface (including air space immediately adjacent to a private structure located on public space or in a PROW), and the area below the surface of any public street, bridge, tunnel, highway, lane, path, alley, sidewalk, or boulevard, where a property line is the line delineating the boundaries of public space and private property.

Important for the following discussion is the definition of the Public Parking Area or ~~Public Parking~~”. This is defined as that area of public space devoted to open space, greenery, parks, or

parking that lies between the property line, which may or may not coincide with the building restriction line, and the edge of the actual or planned sidewalk that is nearer to the property line, as the property line and sidewalk are shown on the records of the District. This area often includes spaces that appear to be front yards with private landscaping that create park-like settings on residential streets.



**Figure B.1 Diagram of typical residential public right-of-way in the District of Columbia (DDOT Public Realm Design Manual 2011).**

Public Space is defined as all the publicly owned property between the property lines on a street, park, or other public property, as such property lines are shown on the records of the District, and includes any roadway, tree space, sidewalk, or parking between such property lines.

Other important terms are the tree box area or planter area and the sidewalk area. These are defined as the area of the roadside that provides a buffer between the pedestrians and vehicles, which primarily contains landscaping such as a continuous planting strip in residential areas. The sidewalk area is sometimes known as the “pedestrian clear zone”, this is the walking zone adjacent to the tree box that must remain clear, both horizontally and vertically.

In the MEP discussion that follows, a PROW project means a land-disturbing activity conducted in the existing PROW and the existing public space associated with the project. The MEP discussion applies only to those PROW projects required for the operation and maintenance of existing commercial and residential streets, existing alleyways, and other existing transportation infrastructure designed and maintained for the safe conveyance of people and commerce. Private subdivision roads or streets shall not be considered PROW projects.

Construction projects to maintain and upgrade the District's PROW are faced with a multitude of unique site constraints that vary widely. Limited space outside of the roadway restricts opportunities for infiltration and evapotranspiration, and in many cases the width of the roadway cannot be reduced to create additional space. In the roadway itself, the structural integrity of the pavement is the prime concern. The weight and volume of traffic loads may limit the use of permeable pavements.

The PROW occupy approximately 25 percent of the impervious area of the District of Columbia, making the PROW one of the most significant sources of stormwater runoff impacting District water bodies. Stormwater runoff from roadways can present high pollutant loading. Despite the challenges to stormwater management faced by PROW projects, it is essential for the protection of District water bodies to strive to achieve full retention of the regulated stormwater volume through the use of BMPs to the MEP on all PROW projects. This means the design process of all PROW projects shall evaluate and implement all applicable and effective BMPs except those shown to be technically infeasible.

The aim for full retention on-site of a PROW project's regulated stormwater volume is consistent with the District of Columbia's Department of Transportation (DDOT) "Complete Streets" policy which states, "improvements to the right-of-way shall consider... environmental enhancements including, reducing right-of-way stormwater run-off, improving water quality, prioritizing and allocating sustainable tree space and planting areas (both surface and subsurface), ... wherever possible". It is also an effort consistent with the District's 2012 Municipal Separated Storm Sewer System (MS4) permit which requires the retrofit for on-site stormwater retention of 1,500,000 sf of PROW by 2016, which might translate to 35.5 miles of 8 foot wide pervious parking lanes or 4.7 miles of 60 foot wide full PROW cross section where the runoff is captured and managed from sidewalks, tree boxes, parking lanes, and the roadway.

The sections that follow, Design Considerations and Decision Process, are intended to provide structure for planners, designers and reviewers to evaluate whether or not a PROW project has exhausted every opportunity to achieve the full retention of the regulated stormwater volume. Achieving the regulated stormwater retention volume (SWR<sub>v</sub>) in the PROW projects will be technically infeasible on many occasions, even after going through the MEP process. Given this and the compelling interest of the ongoing reconstruction of the PROW for the maintenance of public safety and well-being, PROW projects can be excluded from the requirement to use Stormwater Retention Credits (SRCs) or pay an in-lieu fee to satisfy any shortfall in attaining the SWR<sub>v</sub> if the MEP is demonstrated. These PROW projects are the only type of projects that are excluded from this requirement.

DDOE's MEP process applies to two types of projects. One project type, MEP<sub>type1</sub>, is where the reconstruction of the existing PROW constitutes the entirety of a project, such as when the

District of Columbia Department of Transportation reconstructs multiple blocks of a roadway. The second project type, MEP<sub>type2</sub>, is a parcel based development that reconstructs the adjacent existing PROW as part of the development process. Under this project type the PROW reconstruction constitutes a portion of the project. Under the Type 2 scenario, the parcel portion of the application will be reviewed under the full stormwater management performance standards defined in Chapter 2 while the PROW portion of the application will be reviewed under the MEP<sub>Type2</sub> approach. The General Retention Compliance Calculator has a separate PROW worksheet that allows Type 2 applicants to keep separate parcel drainage area obligations from PROW obligations. The final compliance worksheet also presents these separately to keep the review process transparent and simple. An applicant wishing to use MEP<sub>Type 2</sub> review will follow the format used to the request “relief for extraordinarily difficult site conditions” which includes a request memo with supporting evidence in addition to the General Retention Compliance Calculator worksheets. The memo must address the six design steps spelled out in this appendix. Type 2 applicants can choose to follow the same table, plan view and narrative approach identified for Type 1 applicants without the multiple stage review process (30/65/90). Type 1 projects will use a stormwater report that contains information in spreadsheet, plan view and narrative formats for the submission and review of the 30 percent, 65 percent and 90 percent design stages typically of District of Columbia Department of Transportation (DDOT) projects. A sample chart is provided at the end of this appendix to indicate the information expected at each review stage and in which format.

### B.3 Codes

DDOT uses a “functional street classification” system that is defined in Chapter 30 of the Transportation Design and Engineering Manual. There are five functional categories including Freeways, Principal arterials, Minor arterials, Collector streets and Local streets. Table B.1 shows relative distribution of roadway classifications in the District. Each type has design criteria that are governed by traffic volumes, land use, and expected growth. These design criteria set the acceptable ranges for geometric design elements that will govern roadway geometry. The MEP process assumes transportation design criteria govern when conflicting demands exist.

**Table B.1 Roadway Classification and Extent Relative to Total Roadway System**

Type	Approximate Miles	% of District Roadway System
Freeways	46	4
Principal Arterials	92	8
Minor Arterials	178	15
Collectors	152	13
Local Roads	682	60

The MEP process assumes BMP designs will comply with the District of Columbia Department of Transportation Design and Engineering Manual Chapter 33, Chapter 47 and the Design and



Engineering Manual supplements for Low Impact Development and Green Infrastructure Standards and Specifications as well as Chapter 3 in this guidebook.

## **B.4 Design Considerations**

### **B.4.1 Looking Ahead**

**Considerations in the Planning Process (limited to Type 1).** The local capital authority for PROW projects is defined in the District of Columbia's Capital Improvement Program (CIP), a six-year-plan that is updated annually. Federally funded projects are listed in the Transportation Improvement Program (TIP), which is updated every other year according to the Metropolitan Washington Council of Government National Capital Region Transportation Planning Board's (MWCOG TPB) schedule and is also coordinated with the Constrained Long-Range Transportation Plan (CLRP). Each planning stage has an amendment process. Planners shall incorporate the MEP process into all future PROW projects and shall review and revisit, as needed, existing PROW plans for MEP analysis, revisions, and amendments. The TIP and CLRP are able to be amended and modified as allowed by the MWCOG TPB. As projects move from study to design and construction, DDOT will include necessary measures to include MEP analysis and implementation.

### **B.4.2 Site Assessment Considerations for the Retention Standard in Public Right-of-Way (PROW) Projects**

- 1. Level of Disturbance (Type 1 and Type 2).** If a PROW project includes major land-disturbing activity required for the operation and maintenance of existing commercial and residential streets, existing alleyways, and other existing transportation infrastructure designed and maintained for the safe conveyance of people and commerce, it is captured by the stormwater regulatory obligations of Chapter 5 of Title 21, of the District of Columbia Municipal Regulations, Water Quality and Pollution (2012). Routine maintenance such as surface asphalt milling of roadways, where the roadway base is not disturbed, is not considered a level of disturbance that will require compliance with the regulation.
- 2. Available Space (Type 1 and Type 2).** A PROW project must first and foremost seek to maximize landscape areas, maximize available space for stormwater retention, and minimize impervious surface, while coordinating with American Disability Act (ADA) requirements and emergency vehicle needs. Street widths should be reduced to the appropriate minimum width while maintaining traffic flow and public safety. A common rule of thumb is to equate the landscape space to be a minimum of ten percent within each drainage area within the PROW project limits of disturbance.

In the District of Columbia several hundred triangular islands, less than one acre in area, are created by diagonal street intersections. A PROW project must consider the opportunity for stormwater retention within traffic islands, or triangle parks, that fall within, or adjacent to, the project limits of disturbance. Streets that end as cul-de-sacs, are less prevalent in the District, however, when present cul-de-sacs within, or adjacent to, the limits of disturbance of a PROW project must be evaluated for stormwater retention opportunities. In the District "paper streets" exist throughout, as areas of the City dedicated as streets but not useable as transportation passageways. These areas, under the control of the DDOT, may be created by

the intersection of streets with parks and streams, and are often mowed grass areas. “Paper streets” within, or adjacent to, the limits of disturbance of a PROW project must be evaluated for stormwater retention opportunities.

- 3. Impervious Cover Removal (Type 1 & Type 2).** The elimination of impervious surface may be accomplished by closing diagonal roadways adjacent to triangle parks to create larger parks. Diagonal roadways that are adjacent to triangle parks and fall within, or are adjacent to, a PROW project must be evaluated for stormwater retention opportunities. PROW projects must evaluate the opportunity to integrate traffic calming measures including but not limited to, median islands, pedestrian curb extensions, bump outs and chicanes, and turning radius reductions that may double as areas for impervious surface removal and BMPs.

Replacing impervious cover with landscape area in the contributing drainage area converts the runoff coefficient from 95 percent to 25 percent in essence decreasing that area’s contribution to stormwater runoff by 70 percent without the use of an active stormwater facility. If an area can be converted to “natural cover” through conservation and reforestation strategies that area’s contribution to stormwater runoff is reduced to zero. Consult Appendix O for minimum thresholds and other required for each land cover designation. Further opportunities to reduce stormwater runoff in these drainage areas should be explored with adjacent property both public and private as source control may be the most cost effective approach to managing stormwater runoff, see Section 3.4 Impervious Surface Disconnection.

- 4. Drainage Areas (Type 1 and Type 2).** Overall conceptual drainage plans for PROW projects should identify drainage areas outside of the project’s limits of disturbance that generate runoff that may comeingle with on-site runoff. The project is not required to consider off-site runoff in the calculation for the regulated stormwater retention volume (SWRv); however BMPs sized for retention of comingled off-site runoff can be used to off-set the inability to capture and retain the SWRv in areas within the project for which significant constraints prevent retention.

For example, a typical city block will have at least two distinct drainage areas created by the crown in the center of the road. While one side of the road may have significant obstacles to the implementation of retention practices the other may not. If the limits of disturbance are defined by the boundaries of the sidewalks on either side of the roadway this is the area that is used to calculate the SWRv. However, in many circumstances stormwater runoff is entering the sidewalk and roadway from adjacent properties, both public and private, creating a comingled stormwater runoff. Under these conditions the side of the street that has the greater opportunity to implement retention strategies shall be designed to manage that comingled volume up to the full SWRv.

Type 1 and Type 2 projects must prioritize capturing roadway runoff. For Type 2 projects, where limits of disturbance do not extend into the roadway, the capture of roadway runoff from adjacent roadway drainage areas may be accomplished with curb cuts or sidewalk trenches used to direct roadway runoff from the curb line into sidewalk BMPs within the project’s limits of disturbance. This must be the first consideration to satisfy the SWRv calculated for the project’s PROW portion.

- 5. Ownership of Land Adjacent to Right-of-Ways (limited to Type 1).** The opportunity to incorporate stormwater retention may depend on the ownership of land adjacent to the right-of-way. Acquisition of additional right-of-way and/or access easements may only be feasible

if land bordering the project is publicly owned. PROW project must identify public lands and public rights of way adjacent to the project's limit of disturbance. PROW project planners and managers may need to consult with adjacent public property owners and managers to evaluate opportunities to direct stormwater runoff from the project drainage area to adjacent public lands.

6. **Location of Existing Utilities (Type 1 and Type 2).** The location of existing storm drainage utilities (grey infrastructure) can influence the opportunities for stormwater retention in PROW projects. Utilizing the existing grey infrastructure for the conveyance of large events with under drain connections and curb line overflows can reduce costs. Using existing grey infrastructure where possible frees funds for drainage areas within the project limits of disturbance where grey infrastructure does not exist or is more challenging to utilize. Standard peak-flow curb inlets, such as catch basins, should be located downstream of areas with potential for stormwater retention practices so that water can first flow into the BMP, and then overflow to the downstream inlet if capacity of the BMP is exceeded. It is more difficult to apply retention practices after water has entered the storm drain. The location of other utilities will influence the ability connect BMPs to storm drains, and may limit the allowable placement of BMPs to only those areas where a clear pathway to the storm drain exists.

Follow these steps when considering the design and location of BMPs in the existing PROW: 1) avoidance; 2) mitigation; 3) relocation; and 4) acceptance.

*The first step is avoidance.* Whenever possible, locate BMPs to avoid a conflict that either jeopardizes the functionality and longevity of the utility or complicates future utility maintenance. Consult with each utility company on their recommended offsets which will allow utility maintenance work with minimal disturbance to the BMP. A consolidated presentation of the various utility offset recommendations can be found in Chapter 33.14.5 of the District of Columbia Department of Transportation Design and Engineering Manual, latest edition. Consult the District of Columbia Water and Sewer Authority Green Infrastructure Utility Protection Guidelines, latest edition, for water and sewer line recommendations. Avoidance of utility conflicts may mean one BMP type is selected over another. It may mean the sizing of a BMP is altered.

*The second step is mitigation.* Under the mitigation approach the BMP design is adjusted to mitigate utility concerns. A BMP design may need to be resized or otherwise altered to satisfy utility offsets. This may include moving, adding, or deleting a key design feature of the BMP such as check dams, inlets, outlets and trees.

*The third step is relocation.* Under the relocation approach an attempt is made to coordinate with utility companies to allow them to replace or relocate their aging infrastructure while BMPs are being implemented. Where the capital budget and priorities of the utility can be aligned with the larger construction in the PROW, there are potential benefits, including cost savings, for both the utility and the entity undertaking the reconstruction of the PROW. The age of the utility line is a factor in selecting this solution. While a utility relocation during a street re-construction project may be advantageous to the utility provider, it is understood that the utility may not be able to align its capital budget or may be otherwise unable or unwilling to take advantage of the relocation opportunity.

*The fourth step is acceptance.* When the first three steps are inadequate to achieve the required stormwater retention, the fourth step is acceptance of conflicts that do not jeopardize the functionality, longevity and vehicular access to manholes and other key points of utility maintenance. This does not preclude the typical public right-of-way PROW BMP such as street trees, bioretention, or permeable pavement which the utility would be expected to replace if maintenance in those areas was required. In this scenario, a BMP location and design that complicates utility maintenance should be considered acceptable if it does not compromise the utility function, longevity, and major access points. When accepting utility conflict into the BMP location and design, it is understood the BMP will be temporarily impacted during utility work but the utility will replace the BMP or, alternatively, install a functionally comparable BMP according to the specifications in the current version of this Stormwater Management Guidebook and the District of Columbia Department of Transportation Design and Engineering Manual with special attention to Chapter 33, Chapter 47 and the Design and Engineering Manual supplements for Low Impact Development and Green Infrastructure Standards and Specifications. To clarify whether a conflict jeopardizes the functionality, longevity and access to a utility consider the latest editions of the District of Columbia Department of Transportation Design and Engineering Manual and the District of Columbia Water and Sewer Authority Green Infrastructure Utility Protection Guidelines.

7. **Grade Differential Between Road Surface and Storm Drain System (Type 1 and Type 2).** Some BMPs require more head from inlet to outlet than others; therefore, allowable head drop may be an important consideration in BMP selection. Storm drain elevations may be constrained by a variety of factors in a roadway project (utility crossings, outfall elevations, etc.) that cannot be overcome and may override stormwater retention volume considerations.
8. **Longitudinal Slope (limited to Type 1).** The suite of BMPs which may be installed on steeper road sections is more limited. Specifically, permeable pavement and swales are more suitable for gentle grades. Other BMPs may be more readily terraced to be used on steeper slopes. Check dams and weirs should be incorporated into BMP designs on steeper slopes.
9. **Potential Access Opportunities (limited to Type 1).** A significant concern with the installation of BMPs in high speed, high volume PROW is the ability to safely access the BMPs for maintenance considering traffic hazards. A PROW project involving high speed, high volume PROW should include a site assessment to identify vehicle travel lanes and areas of specific safety hazards for maintenance crews. Subsequent steps in the preparation of the stormwater management plan (SWMP) for the PROW project should attempt to avoid placing BMPs in these areas.
10. **Tree Canopy and Vegetation (Type 1 and Type 2).** Concern for the preservation of existing mature trees is a reasonable consideration when determining where and how to direct stormwater runoff from the curb line for retention goals in a PROW project. In general, stormwater retention practices should be installed outside the drip line of existing trees (more specific guidance is provided in Section 3.14). A guiding principal for PROW projects should be the improvement and maintenance of the most robust tree canopy possible along the PROW. The planting of trees and the preservation of trees should look to the latest science on the soil volume requirements, spacing needs and methods to connect stormwater runoff to tree roots to support healthy vigorous tree growth. PROW projects should clearly identify existing healthy trees and detail how to prevent tree losses during construction.

Additionally, diseased and dead trees should be removed. Soils in tree planting areas should be amended and volumes expanded whenever trees are replaced or new trees are planted.

- 11. Infiltration (Type 1 and Type 2).** Infiltration practices have very high storage and retention capabilities when sited and designed appropriately. Designers should evaluate the range of soil properties during initial site layout and seek to configure the site to conserve and protect the soils with the greatest recharge and infiltration rates. In particular, areas of Hydrologic Soil Group A or B soils shown on NRCS soil surveys should be considered as primary locations for infiltration practices. When designing a PROW project consult Appendix P, Geotechnical, and Chapter 3.7, Infiltration, as well as chapters on specific BMPs under consideration in this Stormwater Management Guidebook (SWMG) for specific design details and constraints.

In areas where a qualified professional engineer, soils scientist or geologist determines during an initial feasibility test the presence of soil characteristics which support the categorization as D soils, no further investigation is required. A designer of a PROW project should first consider reducing the impervious surface area draining to these poor soil areas. Other soil types may require further analysis to determine infiltration feasibility. Note: Areas with poor soils may still be sites for BMPs that are designed with underdrains.

If the seasonally high water table is determined to be less than two feet from the bottom of the proposed BMP infiltration may not be appropriate. If the site is one of known soil contamination or receiving uncontrolled stormwater runoff from a land use hotspot, as determined by guidance in Appendix Q. Stormwater Hotspots, infiltration must not be used.

- 12. Street Profile (limited to Type 1).** The profile of an impervious surface such as a street or an alleyway determines how stormwater runoff flows off the surface. District streets follow a crowned design with the high point in the center draining to both sides, alleyways are typically reverse crowned, draining to the center and sidewalks side shed, draining to one side. Flat drainage is a term used to denote vertical drainage through a permeable paving profile. A PROW project should consider all variations of drainage patterns when the standard drainage design does not provide retention for the full regulated stormwater retention volume (SWRV). The drainage patterns of the project should be developed so that drainage can be routed to areas with BMP opportunities before entering storm drains. For example, if a median strip is present, a reverse crown should be considered, so that stormwater can drain to a median swale.

- 13. Pedestrian Circulation (Type 1 and Type 2).** The design of stormwater retention facilities should harmonize with effective pedestrian circulation in PROW projects. PROW project BMPs commonly integrate the goals of stormwater retention and pedestrian safety by reducing pedestrian crossing distances, providing more space against vehicular traffic, and improving site angles at intersections. While pedestrian circulation and stormwater retention should not be at odds, conflicts can arise with on street parking. Considerations should be given to provide adequate egress for parking adjacent to a BMP (typically 3 feet). In addition, frequent walkways across BMPs can give pedestrians sufficient access to parking zones.

Retention facilities with vertical drops of greater than six inches in a PROW projects should provide pedestrians with visual or physical signals that denote a significant drop in grade, such as a raised curb edge, a detectable warning strip or a raised railing. Railings maybe

designed to perform additional functions such as seating or bicycle racks. In areas with the potential for high pedestrian volume railings may be needed to prevent pedestrians from cutting through landscaped areas, trampling vegetation and compacting soils.

### **B.4.3 Fundamental Tenets**

A PROW project shall demonstrate a design approach that indicates stormwater retention opportunities were evaluated to the MEP, which includes the following:

- (a) Selecting BMPs based on site opportunities to reduce stormwater runoff volumes.
- (b) Sizing BMPs opportunistically to provide the maximum stormwater retention while accounting for the many competing considerations in PROW projects.
- (c) Prioritizing capturing roadway runoff. By managing comingled stormwater runoff within some project drainage areas to offset minimum retention achieved in other project drainage areas.
- (d) Developing innovative stormwater management configurations integrating “green” with “grey” infrastructure,
- (e) Minimizing street width to the appropriate minimum width for maintaining traffic flow and public safety.
- (f) Maximizing tree canopy by planting or preserving trees/shrubs, amending soils, increasing soil volumes and connecting tree roots with stormwater runoff.
- (g) Using porous pavement or pavers for low traffic roadways, on-street parking, shoulders or sidewalks.
- (h) Integrating traffic calming measures that serve as stormwater retention BMPs.
- (i) Reducing stormwater runoff volume by converting impervious surfaces to land cover types that generate little or zero stormwater runoff.
- (j) Reducing stormwater runoff volume by employing impervious surface disconnection strategies within and adjacent to the project’s limits of disturbance.

## **B.5 Design Process**

### ***Step 1: Identify Drainage Areas and Calculate SWRv.***

- (a) Define the limits of disturbance for the PROW project.
- (b) Delineate all drainage areas both within, and contributing to, the limits of disturbance for the PROW project. Prioritize drainage areas conveying roadway runoff.
- (c) Identify proposed land covers within the limits of disturbance for the PROW project, including impervious cover, compacted cover, and natural cover. Area under proposed BMPs counts as impervious cover. A continuous planter strip may be consider compacted cover, or natural cover; consult Appendix O for the minimum thresholds an area needs to qualify for each designation. Individual street trees may count as compacted cover or as a BMP. Use the

General Retention Compliance Calculator PROW worksheet to determine which approach provides the greatest SWRv reduction.

- (d) Calculate the regulated stormwater retention volume (SWRv) based on land cover and area within the limits of disturbance for the entire PROW project. Calculate the portion of the SWRv for each drainage area within the limits of disturbance of the PROW project. Calculate any “unregulated” off-site stormwater retention volume contributing to the project limits of disturbance. Note: When off-site stormwater runoff volumes are managed their reduction will count toward a reduction in the SWRv. Off-site stormwater runoff volumes may be managed at the source or within the project’s limits of disturbance. Prioritize drainage areas conveying roadway runoff.
- (e) Consider land conversion and BMP designations in adjacent public lands. While these volumes are not counted in the calculation of the site’s SWRv, if controlled they will count towards the reduction of the site’s SWRv. Identify opportunities for land cover conversions or other source control measures that would reduce these off-site volumes.
- (f) Consider altering the drainage profile if that alteration would increase runoff capture opportunities. This consideration will typically be set aside until all other considerations have been exhausted (limited to Type 1).

**Step 2: Consider Infiltration.**

- (a) Determine historical and actual water table elevations to evaluate opportunities and restrictions for locating infiltration practices.
- (b) Consult a qualified professional engineer, soil scientist or geologist using initial infiltration feasibility tests, to identify the areas within the limits of disturbance with Hydrologic Soil groups that should be preserved and targeted for infiltration BMPs, and areas where infiltration BMPs will require amended soils and under drains.
- (c) Identify any areas within the limits of disturbance where there is a known issue of soil contamination. Infiltration BMPs in these areas are not allowed. Use the guidance in Appendix Q. Stormwater Hotspots to evaluate adjacent land use hotspots that may be a source of uncontrolled contaminants in stormwater runoff.

**Step 3: Demonstrate Full Consideration of Opportunities with Existing Infrastructure.**

- (a) Review substructure maps and utility plans; delineate areas of potential conflict as well as areas without conflict.
- (b) Identify the location and elevation of the existing the storm drainage system (grey infrastructure), including catch basins, drain inlets, and manholes in both the drainage areas within, and those drainage areas contributing stormwater runoff to, the limits of disturbance for the PROW project.
- (c) Identify all existing trees to be preserved. Identify and record tree species, size and preservation status.

**Step 4: Demonstrate Full Consideration of Land Cover Conversions and Optimum BMP Placement.**

- (a) Identify traffic islands, triangle parks, median islands, cul de-de-sacs, and paper streets within and adjacent to the PROW project’s limits of disturbance. These areas can be the

focus of land cover conversions and BMP locations (unless within LOD of Type 2 this is limited Type 1).

- (b) Evaluate the opportunity to integrate traffic calming measures including but not limited to, median islands, pedestrian curb extensions, bump outs and chicanes, and turning radius reductions. Delineate these areas out for consideration for impervious surface removal and BMP facilities. Delineate areas available for additional tree planting. Note whether soil volume increases and amended soils are required (unless within LOD of Type 2 this is limited Type 1).
- (c) Evaluate right-of-way widths; identify minimum requirements for trails, alleys, roadways and sidewalks. Delineate sections where existing conditions exceed minimum requirements. These areas can be the focus of land cover conversions and BMP locations (limited to Type 1).
- (d) Select areas delineated as optimum opportunities for land conversion or BMP location. Note: Land conversions can significantly reduce the project's SWRv without the use of an active stormwater facility. Designate land conversions and recalculate SWRv at the full project scale and the scale of the individual drainage areas within the project area.
- (e) Select most appropriate BMP types for each area delineated as optimum opportunities for BMP locations. Consult Table B.2 for potential BMPs recommended by US EPA for "Green Streets", DDOT's AWI Chapter 5 LID, DDOT's LID Action Plan, DDOT's LID Standards and Specifications, and Chapters 3.1 through 3.12 in this Guidance Manual.

**Step 5: Size BMPs.**

- (a) The following steps are used to size BMPs for PROW projects:
  1. Delineate drainage areas to BMP locations including any area outside the limits of disturbance contributing off-site stormwater runoff volume; prioritize roadway runoff; consider the land covers to compute optimum stormwater retention volume. Consider designing to the over control retention volume, above the regulated requirement of 1.2 inches, up to the regulated ceiling of 1.7 inches.
  2. Look up the recommended sizing methodology for the BMP selected in each drainage area and using the appropriate BMP chapter of this guidance manual to calculate target sizing criteria.
  3. Design BMPs per the appropriate chapter of this guidance manual and the District of Columbia Department of Transportation Design and Engineering Manual.
  4. Attempt to provide the calculated sizing criteria for the selected BMPs.
  5. If sizing criteria cannot be achieved, document the constraints that override the application of BMPs, and provide the largest portion of the sizing criteria that can be reasonably provided given constraints.

Note: If BMPs cannot be sized to provide the calculated volume for the drainage area, it is still essential to design the BMP inlet, energy dissipation, and overflow capacity for the full drainage area, including any area contributing off-site stormwater runoff volume, to ensure that flooding and scour is avoided. It is strongly recommended that BMPs which are designed to less than their target design volume be designed to bypass peak flows.



- (b) Aggregate the retention values achieved with the BMPs designed in Step 5 and compare with the regulated Stormwater Retention Volume (SWRv) for PROW project. If the aggregate retention value meets or exceeds the SWRv the project has meet its regulatory obligation.
- (c) If there is a retention volume deficiency, consider sizing BMPs to manage the comingled volume on-site.
- (d) If there is a retention volume deficiency, revisit Design Steps 1 through 4. Increase land conversion areas and BMP facilities. Depending on the extent and complexity of the PROW project this may require several iterations.

***Step 6: Drainage Areas where Zero-Retention Practices are Installed.***

It is possible, despite following the design consideration, fundamental tenants, and the iterative Steps 1 through 5 of the design process, that drainage areas within the proposed limits of disturbance may emerge without any retention practices. In these cases, those drainage areas will incorporate water quality catch basins, or other emergent technology, that provides water quality treatment for the SWRv of those drainage areas, if the project is in the Municipal Separate Storm Sewer System (MS4).

**Table B.2 Potential BMPs for Green Streets Projects (modified US EPA)**

BMP Type	Opportunity Criteria for PROW Projects
Street Trees, Canopy Interception	<ul style="list-style-type: none"> <li>▪ Access roads, residential streets, local roads and minor arterials</li> <li>▪ Drainage infrastructure, sea walls/break water</li> <li>▪ Effective for projects with any slope</li> <li>▪ Trees may be prohibited along high speed roads for safety reasons or must be setback behind the clear zone or protected with guard rails and barriers; planting setbacks may also be required for traffic and pedestrian lines of sight.</li> </ul>
Stormwater Curb Extensions / Stormwater Planters	<ul style="list-style-type: none"> <li>▪ Access roads, residential streets, and local roads with parallel or angle parking and sidewalks</li> <li>▪ Can be designed to overflow back to curb line and to standard inlet</li> <li>▪ Shape is not important and can be integrated wherever unused space exists</li> <li>▪ Can be installed on relatively steep grades with terracing</li> </ul>
Bioretention Areas	<ul style="list-style-type: none"> <li>▪ Low density residential streets without sidewalks; along roadways adjacent to park space; well suited for DC's triangle parks; ramp, slipways and road closings can make good conversion-sites</li> <li>▪ May require more space than curb extensions/ planters, consider combing with minimized road widths to maximize bioretention area.</li> </ul>
Permeable Pavement	<ul style="list-style-type: none"> <li>▪ Parking and sidewalk areas of residential streets, and local roads</li> <li>▪ If significant run-on from major roads is a possibility ensure design and maintenance protocols to accommodate potential TSS loads</li> <li>▪ Should not be subject to heavy truck/ equipment traffic</li> <li>▪ Light vehicle access roads and alleyways</li> </ul>
Permeable Friction Course Overlays	<ul style="list-style-type: none"> <li>▪ High speed roadways unsuitable for full depth permeable pavement</li> <li>▪ Suitable for parking lots and all roadway types</li> </ul>
Vegetated Swales (compost amended were possible)	<ul style="list-style-type: none"> <li>▪ Roadways with low to moderate slope or terraced systems</li> <li>▪ Residential streets with minimal driveway access</li> <li>▪ Minor to major arterials with medians or mandatory sidewalk set-backs</li> <li>▪ Access roads</li> <li>▪ Swales running parallel to storm drain can have intermittent discharge points to reduce required flow capacity</li> </ul>
Filter strips (amended road shoulder)	<ul style="list-style-type: none"> <li>▪ Access roads</li> <li>▪ Major roadways with excess PROW</li> <li>▪ Not practicable in most PROWs because of width requirements</li> </ul>
Proprietary Biotreatment	<ul style="list-style-type: none"> <li>▪ Constrained PROWs</li> <li>▪ Typically have small footprint to drainage area ratio</li> <li>▪ Simple install and maintenance</li> <li>▪ Can be installed on roadways of any slope</li> <li>▪ Can be designed to overflow back to curb line and to standard inlet</li> </ul>
Infiltration Trench	<ul style="list-style-type: none"> <li>▪ Constrained PROWs</li> <li>▪ Can require small footprint where soils are suitable</li> <li>▪ Low to moderate traffic roadways</li> <li>▪ Infiltration trenches are not suitable for high traffic roadways</li> <li>▪ Requires robust pretreatment</li> </ul>

## B.6 Supporting Forms

**Table B.3 Projects: MEP Submission Elements and Review Points**

Process Steps	Stormwater Report for Type 1 MEP projects								
	thirty percent (30%)			sixty-five percent (65%)			ninety percent (90%)		
	table	plan	narrative	table	plan	narrative	table	plan	narrative
<b>Step 1: Drainage Area and SWRV</b>									
Drainage Area Count	I		I	R		R	F		F
DA List & SWRV per DA	I			R			F		
Project LOD		I			R			F	
DA w/in LOD		I			R			F	
DA outside LOD		I			R			F	
Land cover ID w/in LOD	I			R			F		
Volume calculated per DA	I			R			F		
Volume calculated per DA outside LOD	I			R			F		
Will altered drainage profile increase SWRV?		I	I		R	R			F
Consider adjacent public lands		I			R	R			F
<b>Step 2: Infiltration Assessment</b>									
Water Table conflict per DA (Y/N)	I		I	R		R	F		F
Bedrock Conflict per DA (y/n)	I		I	R		R	F		F
Hydro Soil Group per DA (y/n)	I		I	R		R	F		F
Hotspot concern noted (y/n)	I		I	R		R	F		F
Water table historic & actual elevations evaluation for impact (y/n)					R	R	F	F	
Initial infiltration feasibility tests - id opportunities & restrictions (y/n)					R	R		F	
ID adjacent land use hotspots (y/n)		I			R	R		F	
<b>Step 3: Evaluate Existing Infrastructure</b>									
Utility plans		I			R			F	
Utility conflicts		I			R			F	
Existing Sewer Infrastructure Elevations		I			R			F	
Existing Trees	I	I			R			F	
<b>Step 4: Land Cover Change &amp; BMP Placement Opportunities</b>									
land conversion & BMP placement		I	I		R	R		F	F
Quantify number of BMP, land conversion	I			R			F		
<b>Step 5: Sizing BMPs</b>									
BMP drainage areas - w/in LOD & outside LOD (Y/N)					I			R	
Consider overcontrol of SWRV (Y/N)						I			R
Achieve BMP sizing criteria (Y/N)						I			R
Design sizing achieved/under/over				I			R		
Sizing constraints						I			R
<b>Step 6: Drainage Area w/ Zero Retention Achieved</b>									
SWRV achieved per DA				I		I	F		F
Note									
I = initial findings and presentation; this should define known facts and best opportunities.									
R = revisions based on further investigations and review comments; this will include some firm commitments.									
F = Final design decisions based on initial commitments, interim reviews and final findings.									

## B.7 References

District of Columbia Department of the Environment, 2010, Anacostia Waterfront Transportation Architecture Design Guidelines, Chapter 5: Low Impact Development (LID).

Washington D.C. <http://www.scribd.com/doc/83991242/Anacostia-Waterfront-Transportation-Architecture-Design-Guidelines>

City Council for Montgomery County, Maryland. 2007. Streets and Roads—comprehensive revision. enacted July 3, 2007. Montgomery County, MD.  
<http://www.montgomerycountymd.gov/content/council/pdf/bill/2007/48-06e.pdf>

Philadelphia Water Department, Office of Watersheds, 2009, Stormwater Manual v2.0 Chapter 6.1 Street Design. Philadelphia, PA. <http://www.scribd.com/doc/13322624/Stormwater-Management-Guidance-Manual-Ver-20>

Environmental Services City of Portland, 2008, Green Streets Construction Guide. Portland, OR.  
<http://www.portlandonline.com/bes/index.cfm?c=34602&>

City of Los Angeles, 2009, Green Streets & Green Alleys: design guidelines standards. Los Angeles, CA. [http://www.lastormwater.org/wp-content/files\\_mf/greenstreetguidelines.pdf](http://www.lastormwater.org/wp-content/files_mf/greenstreetguidelines.pdf)

Santa Ana Regional Water Quality Control Board, May 19, 2011. Exhibit 7.III Technical guidance document for the preparation of conceptual/preliminary and/or project water quality management plans (WQMPs); Santa Ana County, CA.  
<http://www.cityoforange.org/civicax/filebank/blobdload.aspx?blobid=9653>

San Francisco Planning Department, 2010, San Francisco Better Streets Plan, Final Draft, 2010,  
[http://www.sf-planning.org/ftp/BetterStreets/proposals.htm#Final\\_Plan](http://www.sf-planning.org/ftp/BetterStreets/proposals.htm#Final_Plan)

San Mateo Countywide Water Pollution Prevention Program, San Mateo County Sustainable Green Streets and Parking Lots Guide, 2009; San Mateo, CA.  
[http://www.flowstobay.org/ms\\_sustainable\\_guidebook.php](http://www.flowstobay.org/ms_sustainable_guidebook.php)

U.S. Environmental Protection Agency, Managing Wet Weather with Green Infrastructure Municipal Handbook, Green Streets, EPA Publication 833-F-08-009, 2008;  
[http://water.epa.gov/infrastructure/greeninfrastructure/upload/gi\\_munichandbook\\_green\\_streets.pdf](http://water.epa.gov/infrastructure/greeninfrastructure/upload/gi_munichandbook_green_streets.pdf)

# **Appendix C      Off-site Retention Forms for Regulated Sites**

This appendix includes the following off-site retention forms for regulated sites:

<b>Form</b>	<b>Page</b>
Application to Use Stormwater Retention Credits for Off-site Retention Volume	C-2
Notification of In-Lieu Fee Payment to Meet Off-Site Retention Volume	C-7



GOVERNMENT OF THE DISTRICT OF COLUMBIA  
DISTRICT DEPARTMENT OF THE ENVIRONMENT



1200 FIRST STREET NE, FIFTH FLOOR, WASHINGTON DC 20002

**APPLICATION TO USE STORMWATER RETENTION CREDITS  
FOR OFF-SITE RETENTION VOLUME**

**ACRONYMS**

<b>AWDZ</b>	ANACOSTIA WATERFRONT DEVELOPMENT ZONE	<b>MS4</b>	MUNICIPAL SEPARATE STORM SEWER SYSTEM
<b>CSS</b>	COMBINED SEWER SYSTEM	<b>OFFV</b>	OFF-SITE RETENTION VOLUME
<b>DDOE</b>	DISTRICT DEPARTMENT OF THE ENVIRONMENT	<b>SRC</b>	STORMWATER RETENTION CREDIT
<b>ILF</b>	IN-LIEU FEE	<b>SWMP</b>	STORMWATER MANAGEMENT PLAN
		<b>SWRV</b>	STORMWATER RETENTION VOLUME

**APPLICATION DATE:** \_\_\_\_\_

**ADDRESS OF REGULATED SITE FOR WHICH SRC USE IS PROPOSED:**

\_\_\_\_\_

LOT: \_\_\_\_\_ SQUARE: \_\_\_\_\_ WARD: \_\_\_\_\_

STORM SEWER SYSTEM (CSS OR MS4): \_\_\_\_\_

**IS THE SITE AN AWDZ SITE (YES OR NO)?** \_\_\_\_\_

**NAME OF SITE OWNER:** \_\_\_\_\_

**ADDRESS:** \_\_\_\_\_

**E-MAIL:** \_\_\_\_\_ **PHONE:** \_\_\_\_\_

**NAME OF OWNER'S AGENT (IF APPLICABLE):** \_\_\_\_\_

**ADDRESS:** \_\_\_\_\_

**E-MAIL:** \_\_\_\_\_ **PHONE:** \_\_\_\_\_

<b>INFORMATION FROM DDOE-APPROVED SWMP FOR REGULATED SITE</b>	
SWMP TRACKING NUMBER	
SWRV	
ON-SITE RETENTION VOLUME ACHIEVED	
OFFV	

**OFFV TO BE MET WITH SRCS (NUMBER OF GALLONS):** \_\_\_\_\_

**FOR AN AWDZ SITE, HOW MUCH OF THE OFFV WILL BE MET WITH SRCS FROM OUTSIDE THE ANACOSTIA RIVER WATERSHED?** \_\_\_\_\_

**OFFV TO BE MET WITH PAYMENT OF ILF (NUMBER OF GALLONS):** \_\_\_\_\_

**SRCS PROPOSED FOR USE (ATTACH ADDITIONAL SHEET IF NECESSARY):**

<b>STARTING DATE FOR USE</b> (INDICATE DATE OR "AS OF FINAL INSPECTION." MULTIPLE DATES MAY BE LISTED.)	<b>SERIAL NUMBERS</b> (MAY INDICATE AS RANGE, WHERE APPROPRIATE)

**APPLICANT'S SIGNATURE**

A. OWNER OF REGULATED PROPERTY: I HEREBY CERTIFY THAT I AM THE OWNER OF THE REGULATED PROPERTY AND OF THE SRCS PROPOSED FOR USE HEREIN AND THAT THIS APPLICATION IS CORRECT TO THE BEST OF MY KNOWLEDGE.

SIGNATURE OF OWNER

DATE:

B. AGENT: I HEREBY CERTIFY THAT I HAVE THE AUTHORITY OF THE REGULATED PROPERTY OWNER TO MAKE THIS APPLICATION. THE OWNER HAS ASSURED ME THAT HE/SHE OWNS THE SRCS PROPOSED FOR USE HEREIN. I DECLARE THAT THIS APPLICATION IS CORRECT TO THE BEST OF MY KNOWLEDGE.

SIGNATURE OF AGENT

DATE:

<b>FOR DEPARTMENT USE ONLY</b>		
APPROVED:	APPROVED IN PART:	DISAPPROVED:
SIGNATURE:		DATE:
NOTES:		





GOVERNMENT OF THE DISTRICT OF COLUMBIA  
DISTRICT DEPARTMENT OF THE ENVIRONMENT



1200 FIRST STREET NE, FIFTH FLOOR, WASHINGTON DC 20002

**INSTRUCTIONS FOR APPLICATION TO USE STORMWATER RETENTION CREDITS**

**FOR OFF-SITE RETENTION VOLUME**

PURPOSE OF FORM: THIS FORM PROVIDES DDOE WITH THE NECESSARY INFORMATION TO TRACK COMPLIANCE WITH AN OFFV BY USE OF SRCS.

NOTE: BUYERS, SELLERS, OR THEIR AGENTS MUST COMPLETE AN APPLICATION FOR TRANSFER OF STORMWATER RETENTION CREDIT OWNERSHIP BEFORE SRCS MAY BE USED TO SATISFY AN OFFV REQUIREMENT.

**INSTRUCTIONS**

**APPLICATION DATE:** ENTER THE DATE THAT THE APPLICANT COMPLETES THE APPLICATION.

**ADDRESS OF REGULATED SITE FOR WHICH SRC USE IS PROPOSED:** ENTER THE STREET ADDRESS FOR THE REGULATED SITE THAT SEEKS TO USE SRCS TO MEET AN OFFV REQUIREMENT. LOT, SQUARE, AND WARD INFORMATION IS AVAILABLE FROM THE BUILDING PERMIT AND THE APPROVED SWMP FOR THE SITE.

**IS THE SITE AN AWDZ SITE (YES OR NO)?** SELECT –YES” OR –NO”. AWDZ SITES MUST PURCHASE SRCS GENERATED OUTSIDE OF THE ANACOSTIA RIVER WATERSHED AT A 1.25:1 RATIO.

**NAME OF SITE OWNER:** ENTER THE NAME OF THE SITE OWNER. ALSO PROVIDE THE SITE OWNER’S CONTACT INFORMATION.

**NAME OF OWNER’S AGENT:** IF APPLICABLE, ENTER THE NAME OF A REPRESENTATIVE WHOM THE OWNER HAS CHARGED WITH ACHIEVING THE OFFV.

**INFORMATION FROM DDOE-APPROVED SWMP FOR REGULATED SITE:** ENTER INFORMATION FROM THE SWMP INCLUDING THE PLAN’S TRACKING NUMBER, TOTAL REQUIRED STORMWATER RETENTION VOLUME IN GALLONS, ON-SITE VOLUME ACHIEVED, AND REQUIRED OFFV.

**OFFV TO BE MET WITH SRCS:** ENTER THE NUMBER OF GALLONS OF THE OFFV REQUIREMENT THAT A SITE OWNER SEEKS TO ACHIEVE THROUGH SRCS.

**FOR AN AWDZ SITE, HOW MUCH OF THE OFFV WILL BE MET WITH SRCS FROM OUTSIDE THE ANACOSTIA RIVER WATERSHED?** AWDZ SITES MUST PURCHASE SRCS GENERATED OUTSIDE OF THE ANACOSTIA RIVER WATERSHED AT A 1.25:1 RATIO. THIS INFORMATION ASSISTS DDOE IN CALCULATING THE CORRECT NUMBER OF SRCS FOR THE REGULATED SITE TO ACHIEVE ITS OFFV REQUIREMENT.

**OFFV TO BE MET WITH PAYMENT OF ILF:** ENTER THE NUMBER OF GALLONS OF THE OFFV TO BE ACHIEVED THROUGH PAYMENT OF THE ILF. TO USE AN ILF PAYMENT FOR COMPLIANCE, SITES MUST ALSO SUBMIT A NOTIFICATION OF IN-LIEU FEE PAYMENT TO MEET OFF-SITE RETENTION VOLUME.

**SRCS PROPOSED FOR USE:** ENTER THE EFFECTIVE DATE WHEN SRCS WILL BE USED TO SATISFY AN OFFV REQUIREMENT. ALSO LIST THE SERIAL NUMBERS OF PURCHASED SRCS.



GOVERNMENT OF THE DISTRICT OF COLUMBIA  
DISTRICT DEPARTMENT OF THE ENVIRONMENT



1200 FIRST STREET NE, FIFTH FLOOR, WASHINGTON DC 20002

**Notification of In-Lieu Fee Payment to Meet  
Off-Site Retention Volume**

**Acronyms**

<b>AWDZ</b>	Anacostia Waterfront Development Zone	<b>MS4</b>	Municipal Separate Storm Sewer System
<b>CSS</b>	Combined Sewer System	<b>Offv</b>	Off-Site Retention Volume
<b>DDOE</b>	District Department of the Environment	<b>SRC</b>	Stormwater Retention Credit
<b>ILF</b>	In-Lieu Fee	<b>SWMP</b>	Stormwater Management Plan
		<b>SWRv</b>	Stormwater Retention Volume

**Application date:** \_\_\_\_\_

**Address of regulated site for which ILF use is proposed:**

\_\_\_\_\_

Lot: \_\_\_\_\_ Square: \_\_\_\_\_ Ward: \_\_\_\_\_ Storm Sewer System (CSS or MS4): \_\_\_\_\_

**Is the site an AWDZ site (Yes or No)?** \_\_\_\_\_

**Name of site owner:** \_\_\_\_\_

**Address:** \_\_\_\_\_

**E-Mail:** \_\_\_\_\_ **Phone:** \_\_\_\_\_

**Name of owner's agent (if applicable):** \_\_\_\_\_

Address: \_\_\_\_\_

E-Mail: \_\_\_\_\_ Phone: \_\_\_\_\_

<b>Information from DDOE-Approved SWMP for regulated site</b>	
SWMP tracking number	
SWR <sub>v</sub>	
On-site retention volume achieved	
Off <sub>v</sub>	

**Off<sub>v</sub> to be met with SRCs (number of gallons):** \_\_\_\_\_

**Off<sub>v</sub> to be met with payment of ILF (number of gallons):** \_\_\_\_\_

**Proposed use of ILF** (Attach additional sheet if necessary).

<b>Starting Date For Use</b> <small>(Indicate date or –as of final inspection.” Multiple years may be listed.)</small>	<b>Total Payment</b>

**Applicant's Signature**

A. Owner of regulated property: I hereby certify that I am the owner of the regulated property and that this application is correct to the best of my knowledge.

Signature of Owner

Date:

B. Agent: I hereby certify that I have the authority of the regulated property owner to make this application. I declare that this application is correct to the best of my knowledge.

Signature of Agent

Date:

<b>FOR DEPARTMENT USE ONLY</b>		
Payment Received:	Payment Received in Part:	Payment Not Received:
Signature:		Date:
Notes:		



GOVERNMENT OF THE DISTRICT OF COLUMBIA  
DISTRICT DEPARTMENT OF THE ENVIRONMENT



1200 FIRST STREET NE, FIFTH FLOOR, WASHINGTON DC 20002

**Instructions for Notification of In-Lieu Fee Payment to Meet  
Off-Site Retention Volume**

Purpose of form: This form provides DDOE with the necessary information to track compliance with an Offv by use of ILF

**Instructions**

**Application date:** Enter the date that the applicant completes the application.

**Address of regulated site for which ILF is proposed:** Enter the street address for the regulated site that seeks to make an ILF payment to meet an Offv. Lot, Square, Ward, and Storm Sewer System information is available from the building permit and the approved SWMP for the site.

**Is the site an AWDZ site (Yes or No)?** Select “yes” or “no”. AWDZ sites must purchase SRCs generated outside of the Anacostia River watershed at a 1.25:1 ratio.

**Name of site owner:** Enter the name of the site owner. Also provide the site owner’s contact information.

**Name of owner’s agent:** If applicable, enter the name of a representative whom the owner has charged with achieving the Offv.

**Information from DDOE-Approved SWMP for regulated site:** Enter information from the SWMP including the Plan’s tracking number, total required stormwater retention volume in gallons, on-site volume achieved, and required Offv.

**Offv to be met with SRCs:** Enter the number of gallons of the Offv requirement that a site owner seeks to achieve through SRCs.

**Offv to be met with payment of in-lieu fee:** Enter the number of gallons of the Offv that a site owner seeks to achieve through payment of the ILF. To use an ILF payment for compliance, sites must also submit a Notification of In-Lieu Fee Payment to Meet Off-Site Retention Volume.

**Proposed use of in-lieu fee:** Enter the effective date when in-lieu fee will be used to satisfy an Offv requirement.

**Appendix D      Stormwater Retention Credit Forms  
(Certification, Trading, and  
Retirement)**



GOVERNMENT OF THE DISTRICT OF COLUMBIA  
DISTRICT DEPARTMENT OF THE ENVIRONMENT



1200 FIRST STREET NE, FIFTH FLOOR, WASHINGTON DC 20002

**Application for Certification of Stormwater Retention Credits**

**Acronyms**

<b>BMP</b>	Best Management Practice	<b>MS4</b>	Municipal Separate Storm Sewer System
<b>CSS</b>	Combined Sewer System	<b>SRC</b>	Stormwater Retention Credit
<b>DDOE</b>	District Department of the Environment	<b>SWMP</b>	Stormwater Management Plan

**Application date:** \_\_\_\_\_

**Address of site with eligible retention capacity:**

\_\_\_\_\_

Lot: \_\_\_\_\_ Square: \_\_\_\_\_ Ward: \_\_\_\_\_ Storm Sewer System (CSS or MS4): \_\_\_\_\_

**Name of owner of proposed SRCs:** \_\_\_\_\_

Address: \_\_\_\_\_

E-Mail: \_\_\_\_\_ Phone: \_\_\_\_\_

**Name of site owner (if different from proposed SRC owner):**

\_\_\_\_\_

Address: \_\_\_\_\_

E-Mail: \_\_\_\_\_ Phone: \_\_\_\_\_



**Name of owner of retention capacity (if different from site owner):**

\_\_\_\_\_

Address: \_\_\_\_\_

E-Mail: \_\_\_\_\_ Phone: \_\_\_\_\_

**Name of agent for owner of proposed SRCs (if applicable):** \_\_\_\_\_

Address: \_\_\_\_\_

E-Mail: \_\_\_\_\_ Phone: \_\_\_\_\_

Should the agent be listed as the contact person for interested SRC buyers in DDOE's SRC registry (Yes or No)? \_\_\_\_\_

**DDOE tracking number for SWMP:** \_\_\_\_\_

**Identification number(s) for each BMP for which SRCs are requested:**

\_\_\_\_\_

**SRC-eligible retention capacity for each BMP or land cover for which SRCs are requested:**

\_\_\_\_\_

---

**Has DDOE previously certified SRCs for the retention capacity (Yes or No)?** \_\_\_\_\_

If no, attach the following:

- As-built SWMP, including site plan showing pre-project site conditions and retention.
- Signed maintenance contract or documentation of capacity and expertise to conduct maintenance for the time period for which SRCs are requested.
- Documentation of the legal right to the SRCs applied for, if the proposed SRC owner is not the property owner.
- Completed DDOE SRC calculator spreadsheet.

If yes, attach the following:

- Signed maintenance contract or documentation of capacity and expertise to conduct maintenance for the time period for which SRCs are requested.
- Documentation of the legal right to the SRCs applied for, if the proposed SRC owner is not the property owner.

**Is this application for SRCs for the maximum three-year period (Yes or No)?** \_\_\_\_\_

**If no, what is the period for which SRCs are requested?** \_\_\_\_\_

**What is the listing price for each SRC (optional)?** \_\_\_\_\_

**Should DDOE list these SRCs and corresponding name and contact information in DDOE's SRC registry (Indicate Yes or No and, if yes, who should be listed):**

\_\_\_\_\_

**Applicant’s Signature**

C. Proposed SRC Owner: I hereby certify that I have the legal right to the SRCs proposed for certification above; that the application, including supporting documentation, is complete and correct to the best of my knowledge; that access will be provided for DDOE inspections; that the retention capacity will be maintained in accordance with the maintenance plan for the period for which SRCs are requested; and that, if the retention capacity is not maintained, I will, for the volume from the period of failed maintenance, forfeit the SRCs, purchase replacement SRCs, or pay in-lieu fee to DDOE.

Signature of Proposed SRC Owner

Date:

D. Agent: I hereby certify that I have the authority of the proposed SRC owner to make this application and that the application and plans are complete and correct to the best of my knowledge. The owner has assured me that access will be provided for DDOE inspections and that the retention capacity will be maintained in accordance with the maintenance plan for the period for which SRCs are requested. If the retention capacity is not maintained in good working order, the proposed SRC owner has assured me that, for the volume from the period of failed maintenance, he will forfeit the SRCs, purchase replacement SRCs, or pay in-lieu fee to DDOE.

Signature of Agent

Date:

<b>FOR DEPARTMENT USE ONLY</b>		
Approved:	Approved in part:	Disapproved:
Signature:		Date:
Total SRCs certified:	Total time period for which SRCs are certified:	
SRCs certified year 1:	Serial numbers:	
SRCs certified year 2:	Serial numbers:	
SRCs certified year 3	Serial numbers:	
Notes:		



GOVERNMENT OF THE DISTRICT OF COLUMBIA  
DISTRICT DEPARTMENT OF THE ENVIRONMENT



1200 FIRST STREET NE, FIFTH FLOOR, WASHINGTON DC 20002

**Instructions for Application for Certification of Stormwater Retention Credits**

Purpose of form: This form provides DDOE with the necessary information to certify SRCs.

NOTE: Buyers, sellers, or their agents must complete an Application for Transfer of Storm Retention Credit Ownership before an SRC transaction may occur.

**Instructions**

**Application date:** Enter the date that the applicant completes the application.

**Address of site with eligible retention capacity:** Enter the street address for the site with retention capacity that complies with the eligibility requirements for SRC certification. Lot, square, and ward information is available from the building permit and the approved SWMP for the site.

**Name of owner of proposed SRCs:** Enter the name and contact information for the person proposed as the owner of the SRCs. Once DDOE certifies the SRCs, this person will become the original SRC owner, with associated maintenance obligation. This person or their agent signs the application form. Once SRCs are certified or the agent signs the application, DDOE will notify the proposed SRC owner of its determination for the application. DDOE will list the original SRC owner (or the owner's agent) and contact information in a public registry posted to the DDOE website.

**Name of site owner:** If different from the proposed SRC owner, enter the name and contact information for the person who owns the site where practices are installed to generate SRCs. DDOE recognizes that a site owner could assign the right to the SRCs to an SRC aggregator or other person. In such a case, the SRC aggregator or other person would presumably be the proposed SRC owner.

**Name of owner of retention capacity:** If different from site owner, enter the name and contact information for the owner of the retention capacity generating SRCs on a site. DDOE expects that typically the site owner would also be the owner of the retention capacity, but this may not always be the case.

**Name of agent for owner of proposed SRCs (if applicable):** Enter the name and contact information for a person who is authorized to represent the proposed SRC owner in applying for certification of SRCs. If the agent is also authorized to represent (and take the place of) the proposed SRC owner in DDOE's SRC registry as the contact for interested SRC buyers, that should be indicated.

**DDOE tracking number for SWMP:** Enter the tracking number assigned to the SWMP by DDOE.

**Identification number(s) for each BMP for which SRCs are requested:** Enter the tracking number for the BMP, as identified in the SWMP. This will allow DDOE to identify the specific BMP on a site for which SRCs are being requested and for which maintenance will be required. Some sites may have multiple BMPs.

**SRC-eligible retention capacity for each BMP or land cover for which SRCs are requested:** Enter the SRC-eligible volume, as identified in the as-built SWMP for a site. For a site with one SRC-eligible BMP or land cover, this will typically correspond to cell B:50 of the SRC calculator.

**Has DDOE previously certified SRCs for the retention capacity?** Select “yes” or “no”. DDOE certifies SRCs for three-year periods. If the retention capacity continues to be maintained and function properly, applicants may apply for an additional three years of SRCs.

**Is this application for SRCs for the maximum three-year period?** Select “yes” or “no”. DDOE certifies SRCs for three year periods, but applicants should apply for fewer years if they do not intend to maintain the retention capacity for the entire three-year time period.

**If no, what is the period for which SRCs are requested?** Enter the period of time for which the applicant requests SRCs.

**What is the listing price for for each SRC (optional)?** If the applicant would like DDOE to include an SRC price in the SRC registry, indicate that here. This is not binding, and the final price will be determined by the SRC seller and buyer.

**Should DDOE list these SRCs and corresponding name and contact information in DDOE’s SRC registry?** Indicate whether the proposed SRC owner or the owner’s agent would like the SRCs to be listed in DDOE’s SRC registry. Also indicate whether contact information for the owner or agent should be listed.



GOVERNMENT OF THE DISTRICT OF COLUMBIA  
DISTRICT DEPARTMENT OF THE ENVIRONMENT



1200 FIRST STREET NE, FIFTH FLOOR, WASHINGTON DC 20002

**Application for Transfer  
of Stormwater Retention Credit Ownership**

**Acronyms**

<b>DDOE</b>	District Department of the Environment	<b>SRC</b>	Stormwater Retention Credit
-------------	--	------------	-----------------------------

**Application date:** \_\_\_\_\_

**Number of SRCs to transfer:** \_\_\_\_\_

**Serial numbers of SRCs (may be listed as a range):**

**Purchase price for SRCs:** \_\_\_\_\_

**Name of current owner of SRCs:** \_\_\_\_\_

Address: \_\_\_\_\_

E-Mail: \_\_\_\_\_ Phone: \_\_\_\_\_

**Name of new owner of SRCs:** \_\_\_\_\_

Address: \_\_\_\_\_

E-Mail: \_\_\_\_\_ Phone: \_\_\_\_\_

**Name of agent for new owner of SRCs (if applicable):**

\_\_\_\_\_

Address: \_\_\_\_\_

E-Mail: \_\_\_\_\_ Phone: \_\_\_\_\_

**Should DDOE list these SRCs and the name and contact information for the owner or owner's agent in DDOE's SRC registry? (Indicate Yes or No and, if yes, who should be listed)**

\_\_\_\_\_

**Signature of Current Owner**

I hereby certify that I am the owner of the above SRCs; that I request the ownership of these SRCs to be transferred as stated above; and that this application is complete and correct to the best of my knowledge.

Signature:

Date:

**Signature of New Owner (or Owner's Agent)**

I hereby certify that this application is complete and correct to the best of my knowledge.

Signature:

Date:

<b>FOR DEPARTMENT USE ONLY</b>		
Approved:	Approved in part:	Disapproved:
Signature:		Date:
Notes:		





GOVERNMENT OF THE DISTRICT OF COLUMBIA  
DISTRICT DEPARTMENT OF THE ENVIRONMENT



1200 FIRST STREET NE, FIFTH FLOOR, WASHINGTON DC 20002

**Instructions for Application for Transfer  
of Stormwater Retention Credit Ownership**

Purpose of form: This form provides DDOE with the necessary information to verify and track ownership of SRCs and the price at which SRCs are traded.

**Instructions**

**Application date:** Enter the date that the applicant completes the application.

**Number of SRCs to transfer:** Enter the number of SRCs that are proposed for transfer from a seller to buyer.

**Serial numbers of SRCs (may be listed as a range):** Enter the serial numbers for SRCs to be transferred. Individually list serial numbers for SRCs that are not in sequential order. Use a range for sequential SRCs.

**Purchase price for SRCs:** Enter the price for each SRC to be transferred. If prices vary for different SRCs being transferred, enter each of the prices and the corresponding SRCs. DDOE will share price information on its website.

**Name of current owner of SRCs:** Enter the name and contact information for the current owner of SRCs to be transferred to the new owner.

**Name of new owner of SRCs:** Enter the name and contact information for the person to whom the SRCs will be transferred. DDOE will list the new owner on its SRC registry, unless the new owner requests not to be listed.

**Name of agent for new owner:** If applicable, enter the name and contact information for the agent of the new owner.

**Should DDOE list these SRCs and the new owner's name and contact information in DDOE's SRC registry?** Indicate whether the new SRC owner or the owner's agent would like the SRCs to be listed in DDOE's SRC registry. Also indicate whether the listed contact information should be for the new owner or the agent.



GOVERNMENT OF THE DISTRICT OF COLUMBIA  
DISTRICT DEPARTMENT OF THE ENVIRONMENT



1200 FIRST STREET NE, FIFTH FLOOR, WASHINGTON DC 20002

**Application to Retire Stormwater Retention Credits**

**Acronyms**

**DDOE** District Department of the Environment      **SRC** Stormwater Retention Credit

**Application date:** \_\_\_\_\_

**Number of SRCs to retire:** \_\_\_\_\_

**Serial numbers of SRCs (may be listed as a range):**

**Name of current owner of SRCs:** \_\_\_\_\_

**Address:** \_\_\_\_\_

**E-Mail:** \_\_\_\_\_ **Phone:** \_\_\_\_\_

**Signature of SRC Owner**

I hereby certify that I am the owner of the above SRCs; that I request these SRCs to be retired; and that this application is complete and correct to the best of my knowledge.

Signature:

Date:

<b>FOR DEPARTMENT USE ONLY</b>		
Approved:	Approved in part:	Disapproved:
Signature:		Date:
Notes:		



GOVERNMENT OF THE DISTRICT OF COLUMBIA  
DISTRICT DEPARTMENT OF THE ENVIRONMENT



1200 FIRST STREET NE, FIFTH FLOOR, WASHINGTON DC 20002

**Instructions for Application to Retire Stormwater Retention Credits**

Purpose of form: This form provides DDOE with the necessary information to retire SRCs and track accordingly.

**Instructions**

**Application date:** Enter the date that the applicant completes the application.

**Number of SRCs to retire:** Enter the number of SRCs that are proposed for retirement.

**Serial numbers of SRCs (may be listed as a range):** Enter the serial numbers for SRCs to be retired. Individually list serial numbers for SRCs that are not in sequential order. Use a range for sequential SRCs.

**Name of current owner of SRCs:** Enter the name and contact information for the owner of the SRCs.

# **Appendix E      Relief for Extraordinarily Difficult Site Conditions**

## **E.1 Relief from Extraordinarily Difficult Site Conditions**

Note that major land-disturbing activity in the existing public right-of-way (PROW) uses the maximum extent practicable process detailed in Appendix B to determine sizing criteria used to achieve the stormwater management performance requirements for regulated activity. These projects are not required to apply for relief from extraordinarily difficult site conditions.

Regulated activity located in the Anacostia Waterfront Development Zone (AWDZ) that are governed by the Anacostia Waterfront Environmental Standards Amendment Act of 2012 (see D.C. Official Code §§ 2-1226.36(c)(1)) must have all off-site retention and all off-site water quality treatment volume approved by DDOE through the process defined in this appendix, even if the District-wide minimum 50 percent on-site retention requirement is met. All development sites are required to address the Stormwater Retention Volume (SWRv), as described in Chapter 2. All development sites in the Anacostia Waterfront Development Zone (AWDZ), governed by the Anacostia Waterfront Environmental Standards Amendment Act of 2012, are required to address the Water Quality Treatment Volume (WQTV), as described in Chapter 2. If compliance with the minimum on-site retention requirement or on-site water quality treatment requirement is technically infeasible or environmentally harmful, the applicant may apply for relief from extraordinarily difficult site conditions. Additionally, if the regulated activity is in the Anacostia Waterfront Development Zone (AWDZ), governed by the Anacostia Waterfront Environmental Standards Amendment Act of 2012, consideration for a request for relief will include the limited appropriateness of on-site compliance in terms of impact on surrounding landowners or overall benefit to District waterbodies. In cases where an applicant claims extraordinarily difficult site conditions, it is the responsibility of the applicant to provide sufficient evidence to support the claim.

Once granted relief from extraordinarily difficult site conditions, an applicant is allowed to provide less than the minimum compliance requirements on-site by managing a greater retention volume or water quality treatment volume through off-site mitigation. This process does not relieve the applicant from the obligation to manage the full SWRv or the WQTV determined through compliance calculations. Additionally, stormwater runoff not receiving the minimum on-site retention must receive treatment to remove 80 percent of total suspended solids based on the treatment practices, as defined in Chapter 3 of this guidance manual. When DDOE finds the evidence presented is sufficient and compelling to grant relief, the Stormwater Management Plan (SWMP) for the project must the two conditions for relief have been satisfied: (1) removing 80 percent of total suspended solids from 50% of the SWRv and (2) identifying the requirement for the use of off-site retention to offset the entire on-site retention deficit.

## **E.2 Submission requirements for Relief from Extraordinarily Difficult Site Conditions**

A request for relief is made through a “relief request memo.” The memo is submitted as part of the SWMP with supporting evidence to demonstrate the claim of technical infeasibility or environmental harm. The memo shall provide a detailed explanation of each opportunity for on-site installation of retention BMPs that was considered and rejected, and the reasons for each rejection. The applicant shall address each retention practice specified in this guidance manual in BMP groups 1 through 13, specifically,

BMP Group 1	Green Roofs
BMP Group 2	Rainwater Harvesting
BMP Group 3	Impermeable Surface Disconnection
BMP Group 4	Permeable Pavement Systems
BMP Group 5	Bioretention
BMP Group 7	Infiltration
BMP Group 8	Open Channel Systems
BMP Group 13	Tree Planting

Evidence of site conditions limiting each opportunity for a retention BMP include the following:

1. Data on soil and groundwater contamination;
2. Data from soils testing consistent with the geotechnical requirements in Appendix P;
3. Documentation of the presence of utilities requiring impermeable protection or a setback;
4. Evidence of the applicability of a statute, regulation, court order, pre-existing covenant, or other restriction having the force of law;
5. Evidence that the installation of a retention BMP would conflict with the terms of a non-expired approval, applied for prior to the end of Transition Period Two A for a major land-disturbing activity or before the end of Transition Period Two B for a major substantial improvement activity, of a:
  - (a) Concept review by the Historic Preservation Review Board;
  - (b) Concept review by the Commission on Fine Arts;
  - (c) Preliminary or final design submission by the National Capital Planning Commission;
  - (d) Variance or special exception from the Board of Zoning Adjustment; or
  - (e) Large Tract Review by the District Office of Planning; and
6. For a utility, evidence that a property owner on or under whose land the utility is conducting work objects to the installation of a BMP; and

7. For a major substantial improvement activity, evidence that the structure cannot accommodate a BMP without significant alteration, because of a lack of available interior or exterior space or limited load-bearing capacity.

Projects in the AWDZ, governed by the Anacostia Waterfront Environmental Standards Amendment Act of 2012, may also discuss the limited appropriateness of on-site compliance verses a combination of off-site and on-site retention and or water quality treatment in terms of the impact on surrounding landowners or the overall benefit to District waterbodies.

### **E.3 Review of Requests for Relief from Extraordinarily Difficult Site Conditions**

In an application for Relief from Extraordinarily Difficult Site Conditions, a completed application and proof of payment of the applicable fee are required to begin the review of the request. DDOE cannot render a final decision until an application for relief is considered complete. However, if an application is substantially complete, DDOE may begin consideration of the request for relief. Upon accepting an application, DDOE will review and determine whether the application meets the requirements of this section, including the following:

- (a) Require additional information;
- (b) Grant relief;
- (c) Grant relief, with conditions;
- (d) Deny relief; or
- (e) Deny relief in part.

In determining whether to grant relief, DDOE may consider the following:

- (a) The applicant's submittal;
- (b) Other site-related information;
- (c) An alternative design;
- (d) DDOE's Stormwater Management Guidebook (SWMG);
- (e) Another BMP that meets the SWMG's approval requirements; and
- (f) Relevant scientific and technical literature, reports, guidance, and standards.





# Appendix F Stormwater Conveyance System Design

## F.1 Design of Stormwater Conveyance Systems

The Chezy-Manning formula is to be used to compute the system's transport capacities:

$$Q = \frac{1.486}{n} \times A \times R^{2/3} \times S^{1/2}$$

where:

- Q = channel flow (cfs)
- n = Manning's roughness coefficient (Table F.1)
- A = cross-sectional area of flow (ft<sup>2</sup>)
- R = hydraulic radius (ft)
- S = channel slope (ft/ft)
- W<sub>p</sub> = wetland perimeter
- R = A/WP

**Table F.1 Manning's Roughness Coefficient (n) Values for Various Channel Materials**

Channel Materials	Roughness Coefficient
Concrete pipe and precast culverts	
24 inches and smaller	0.015
27 inches and larger	0.013
Monolithic concrete in boxes, channels	0.015
Corrugated metal	0.022
PVC pipes	0.011
Sodded channel with water depth < 1.5'	0.050
Sodded channel with water depth > 1.5'	0.035
Smooth earth channel or bottom of wide channels with sodded slopes	0.025
Rip-rap channels	0.035

Note: Where drainage systems are composed of more than one of the above channel materials, a composite roughness coefficient must be computed in proportion to the wetted perimeter of the different materials.

Also, the computation for the flow velocity of the channel must use the continuity equation as follows:

$$Q = A \times V$$

where:

- $V$  = velocity (ft/s)
- $A$  = cross-sectional area of the flow (ft<sup>2</sup>)

### F.1.1 Gutters

With uniform cross slope and composite gutter section use the following equation:

$$Q = \frac{0.50}{n} \times S_x^{1.67} \times S^{0.5} \times T^{2.67}$$

where:

- $Q$  = flow rate (cfs)
- $n$  = Manning's roughness coefficient (Table F.1)
- $S_x$  = cross slope (ft/ft)
- $S$  = longitudinal slope (ft/ft)
- $T$  = width of flow (spread) (ft)

### F.1.2 Inlets

In accordance with the current requirements of the District of Columbia Plumbing Code, all inlets on private or public parcels, but outside the public right-of-way (PROW), must be sized to ensure safe conveyance of stormwater flows exceeding the capacity of the approved on-site stormwater management practices and the designated pervious land cover areas. These stormwater flows must not flow over property lines onto adjacent lots unless these flows run into an existing natural water course. Stormwater inlets in the PROW must be designed in accordance with the current requirements in Chapter 33 of the District of Columbia Department of Transportation Design and Engineering Manual and be approved for use by the District of Columbia Water and Sewer Authority.

### F.1.3 Street Capacity (Spread)

Design of the conveyance of stormwater runoff within the public right-of-way must follow the current requirements in the Design and Engineering Manual of the District of Columbia Department of Transportation. The roadway drainage design criteria for existing streets is a 15-year storm, 5-minute duration, and a maximum spread of 6 feet from the face of the curb (32.3.13 DDOT Design and Engineering Manual 2009). Proposed streets must use AASHTO Chapter VI for their design criteria.

### F.1.4 Manhole and Inlet Energy Losses

The following formulas must be used to calculate headloss:

$$HL = \frac{V_{outlet}^2 - V_r^2}{2g} + SL$$

$$V_r = \frac{Q(V \cos \frac{a}{2})(inlet1) + Q(V \cos \frac{a}{2})(inlet2) + \dots}{Q(outlet)}$$

where:

- $HL$  = headloss in the structure
- $V_r$  = resultant velocity
- $g$  = gravitational acceleration (32.2 ft/s<sup>2</sup>)
- $SL$  = minimum structure loss
- $a$  = angle between the inlet and outlet pipes (180°)

Table F.2 provides the minimum structure loss for inlets, manholes, and other inlet structures for use in the headloss calculation.

**Table F.2 Minimum Structure Loss to Use in Hydraulic Grade Line Calculation**

Velocity, $V_{outlet}$ (ft/s)*	Structure Loss, SL
2	0.00
3	0.05
4	0.10
5	0.15
6	0.20
6	0.25

\* Velocities leaving the structure.

Headloss at the field connection is to be calculated like those structures, eliminating the structure loss. For the angular loss coefficient,  $\cos a/2$  is assumed to be 1.

### F.1.5 Open Channels

- Calculations must be provided for all channels, streams, ditches, swales and etc., including a typical section of each reach and a plan view with reach locations. In the case of existing natural streams/swales, a field survey of the stream (swale) cross sections may be required prior to the final approval.

- The final designed channel must provide a 6-inch minimum freeboard above the designated water surface profile of the channel.
- If the base flow exists for a long period of time or velocities are more than five feet per second in earth and sodded channel linings, gabion or rip-rap protection must be provided at the intersection of the inverts and side slopes of the channels unless it can be demonstrated that the final bank and vegetation are sufficiently erosion-resistant to withstand the designed flows, and the channel will stay within the floodplain easement throughout the project life.
- Channel inverts and tops of bank are to be shown in plan and profile views.
- For a designed channel, a cross section view of each configuration must be shown.
- For proposed channels, a final grading plan must be provided.
- The limits of a recorded 100-year floodplain easement or surface water easement sufficient to convey the 100 year flow must be shown.
- The minimum 25-foot horizontal clearance between a residential structure and 100 year floodplain must be indicated in the plan.
- For designed channels, transition at the entrance and outfall is to be clearly shown on the site plan and profile views.

#### **F.1.6 Pipe Systems**

- Individual stormwater traps must be installed on the storm drain branch serving each structural best management practice, or a single trap must be installed in the main storm drain after it leaves the structural best management practice and before it connects with the city's combined sewer. Such traps must be provided with an accessible cleanout. The traps must not be required for storm drains which are connected to a separate storm sewer system.
- The pipe sizes used for any part of the storm drainage system within the public right-of-way must follow District of Columbia Water and Sewer Authority Standard and Specifications. The minimum pipe size to be used for any part of a private storm drainage system must follow the current requirements of the District of Columbia Plumbing Code.
- The material and installation of the storm drain for any part of public storm sewer must follow District of Columbia Water and Sewer Authority Standard and Specifications.
- An alternative overflow path for the 100-year storm is to be shown on the plan view if the path is not directly over the pipe. Where applicable, proposed grading must ensure that overflow will be into attenuation facilities designed to control the 100-year storm.
- A pipe schedule tabulating pipe lengths by diameter and class is to be included on the drawings. Public and private systems must be shown separately.
- Profiles of the proposed storm drains must indicate size, type, and class of pipe, percent grade, existing ground and proposed ground over the proposed system, and invert elevations at both ends of each pipe run. Pipe elevations and grades must be set to avoid hydrostatic surcharge during design conditions. Where hydrostatic surcharge greater than one foot of head cannot be avoided, a rubber gasket pipe is to be specified.

### F.1.7 Culverts

Culverts must be built at the lowest point to pass the water across embankment of pond or highway. Inlet structure must be designed to resist long term erosion and increased hydraulic capacities of culverts. Outlet structures must be designed to protect outlets from future scouring. The following formulas are to be used in computing the culvert:

If the outlet is submerged then the culvert discharge is controlled by the tail water elevation:

$$h = h_e + h_f + h_v$$

where:

- $h$  = head required to pass given quantity of water through culvert flowing in outlet control with barrel flowing full throughout its length
- $h_e$  = entrance loss
- $h_f$  = friction loss
- $h_v$  = velocity head

and

$$h = k_e \left( \frac{V^2}{2g} \right) + \frac{n^2 V^2 L}{2.21R^{4/3}} + \frac{V^2}{2g}$$

$$h = \left[ k_e + \frac{n^2 L}{2.21R^{4/3}} \times 2g + 1 \right] \times \left( \frac{V^2}{2g} \right)$$

$$h = \left[ k_e + \frac{n^2 L}{2.21R^{4/3}} \times 2g + 1 \right] \times \left( \frac{8Q^2}{9.87gD^4} \right)$$

where:

- $k_e$  = entrance loss coefficient = 0.5 for a square-edged entrance  
entrance loss coefficient = 0.1 for a well-rounded entrance
- $V$  = mean or average velocity in the culvert barrel (ft/s)
- $g$  = 32.2ft/s<sup>2</sup> (gravitational acceleration)
- $n$  = Manning's roughness coefficient = 0.012 for concrete pipe
- $L$  = length of culvert barrel (ft)
- $R$  = 0.25D = hydraulic radius (ft)
- $Q$  = flow (cfs)
- $D$  = diameter (ft)

If the normal depth of the culvert is larger than the barrel height, the culvert will flow into a full or partially full pipe. The culvert discharge is controlled by the entrance conditions or entrance control.

$$Q = C_d A (2gh)^{0.5}$$

where:

$Q$	=	discharge (cfs)
$C_d$	=	discharge coefficient = 0.62 for square-edged entrance discharge coefficient = 0.1 for well-rounded entrance
$A$	=	cross sectional area (ft <sup>2</sup> )
$g$	=	32.2ft/s <sup>2</sup> (gravitational acceleration)
$h$	=	hydrostatic head above the center of the orifice (ft)

If the hydrostatic head is less than 1.2D, the culvert will flow under no pressure as an open channel system.

If the flows are submerged at both ends of the culvert, use Figure F.1.

### F.1.8 Hydraulic Grade Line

A hydraulic grade line (HGL) must be clearly indicated on the system profiles and identified with the initials HGL on the line and identified in the legend key. This grade line must take into consideration pipe and channel friction losses, computing structures losses, tail water conditions and entrance losses. All pipe systems must be designed so that they will operate without building up a surcharged hydrostatic head under design flow conditions. It is recommended that the HGL be no more than 1 foot above the pipe crown. If pipes have a HGL more than 1 foot above the pipe crown, rubber gaskets are required.

If the structural best management practice discharges into a storm sewer or a combined sewer system, a detailed HGL analysis of the system including the receiving system must be submitted with the final stormwater management plans for the 15- and 100-year flow frequencies. If the time characteristics of the HGL are unknown, the designed structural best management practice must be functional under expected minimum and maximum grade lines.

### F.1.9 Manholes and Inlets

- District of Columbia Water and Sewer Authority Standards and Specifications must be used. All structures are to be numbered and listed in the structure schedule and must include type, standard detail number, size, top elevation, slot elevation and locations, and modification notes.
- Access structures must be spaced according to the District of Columbia Water and Sewer Authority Standards and Specifications and the Design and Engineering Manual of the District of Columbia Department of Transportation.
- A minimum drop of 0.1 foot must be provided through the structure invert.
- Drainage boundary and contours must be shown around each inlet to ensure that positive drainage to the proposed inlet is provided.
- Invert elevations of the pipes entering and leaving the structures must be shown in the profile view.

- Yard or grate inlets must show the 15-year and 100-year ponding limits (if applicable). A depth of not more than two feet is allowed from the throat or grate to the 100-year storm elevation.
- Public street inlets must follow District of Columbia Water and Sewer Authority and District of Columbia Department of Transportation criteria.
- Additional structures are recommended and may be required on steep slopes to reduce excessive pipe depths and/or to provide deliberate drops in the main line to facilitate safe conveyance to a proper outfall discharge point. In order to provide an outfall at a suitable slope (i.e., less than 5 percent slope), drop structures may need to be used to reduce the velocity before discharging on a rip-rap area.
- Curb inlets located on private cul-de-sacs must have a maximum 10 linear feet opening.
- Where two or more pipes enter a structure, a minimum of two feet horizontal clearance must be maintained between the pipes connected to the structure at the same elevation.

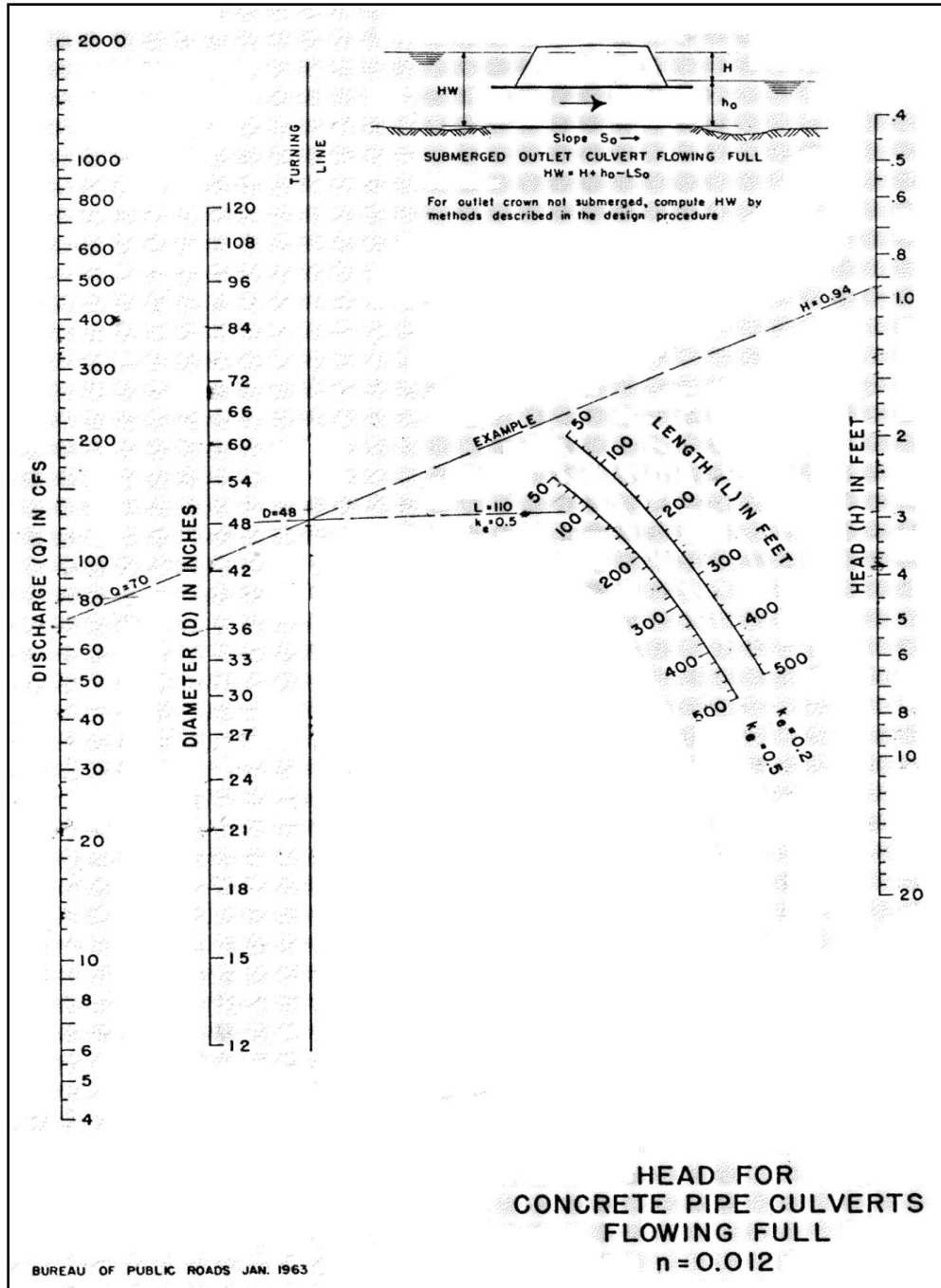


Figure F.1 Typical nomograph for culverts under outlet control.

- For commercial/industrial areas, inlets must be kept at least five feet away from the driveway aprons.

The determination of the minimum width of a structure based on incoming pipes is based on the following formula:



$$W = \frac{D}{\sin \theta} + \frac{T}{\tan \theta}$$

where:

- $D$  = pipe diameter (outside)
- $T$  = inlet wall thickness
- $W$  = minimum structure width (inside)
- $\theta$  = angle of pipe entering structure

#### **F.1.10 Clearance with Other Utilities**

- All proposed and existing utilities crossing or parallel to designed storm sewer systems must be shown on the plan and profile.
- Storm drain and utility crossings must not have be less than a 45-degree angle between them.
- A minimum vertical clearance of one foot and a minimum horizontal clearance of five feet, wall to wall, must be provided between storm drainage lines and other utilities. Exceptions may be granted by the District of Columbia Water and Sewer Authority (DC Water) on a case-by-case basis when justified. Consult DC Water’s Project Design Manual, latest addition, for details.



# Appendix G Design of Flow Control Structures

## G.1 Design of Flow Control Structures

Flow control devices are orifices and weirs. The following formulas shall be used in computing maximum release rates from the designed stormwater management facility.

### G.1.1 Circular Orifices

$$Q = CA(2gh)^{0.5}$$

where:

- $Q$  = orifice discharge (cfs)
- $C$  = discharge coefficient = 0.6
- $A$  = orifice cross-sectional area (ft<sup>2</sup>) = 3.1416(D<sup>2</sup>/4)
- $g$  = gravitational acceleration (ft/s<sup>2</sup>) = 32.2
- $h$  = hydraulic head above the center of the orifice (ft)

When  $h < D$ , the orifice shall be treated as a weir:

$$Q = CLH^{3/2}$$

where:

- $Q$  = flow through the weir (cfs)
- $C$  = 3
- $L$  = diameter of orifice (ft)
- $H$  = hydraulic head above bottom of weir opening (ft)

### G.1.2 Flow Under Gates

Flow under a vertical gate can be treated as a square orifice. For submerged conditions:

When outflow is not influenced by downstream water level:

$$Q = b \times a \times C \times \left[ 2g \times \left( \frac{H_0}{H_0 + H_i} \right) \right]^{0.5}$$

where:

- $Q$  = flow through the gate (cfs)
- $b$  = width of gate (ft)
- $a$  = gate opening height (ft)

- $C$  = discharge coefficient
- $G$  = 32.2 ft/s<sup>2</sup> (gravitational acceleration)

When outflow is influenced by downstream water level:

$$Q' = KQ$$

where:

- $Q$  = flow through the gate (cfs)
- $K$  = coefficient found in Figure G.1

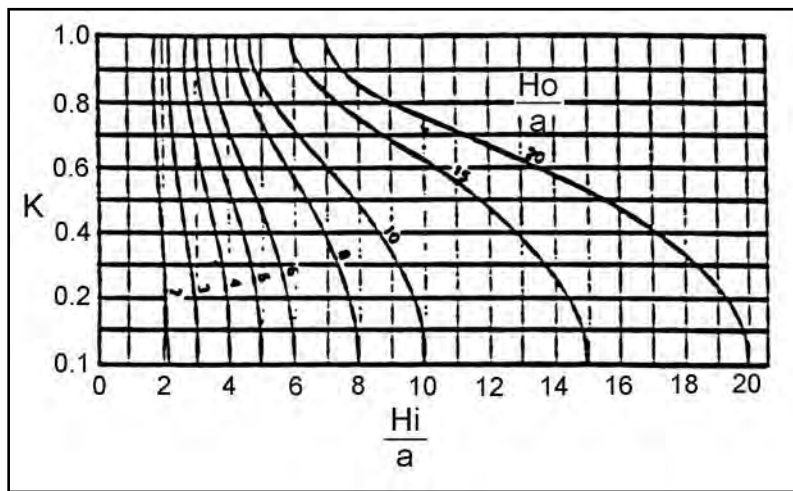


Figure G.1 Absolute downstream control of flow under gate.

### G.1.3 Weirs

Rectangular:

$$Q = 3.33H^{1.5}(L - 0.2H)$$

60o V-notch:

$$Q = 1.43H^{2.5}$$

90o V-notch:

$$Q = 2.49H^{2.48}$$

where:

- $Q$  = flow through the weir (cfs)
- $H$  = hydraulic head above the bottom of the weir (ft)
- $L$  = length of the weir crest (ft)



# Appendix H      Acceptable Hydrological Methods and Models

## H.1    Acceptable Hydrologic Methods and Models

The following are the acceptable methodologies and computer models for estimating runoff hydrographs before and after development. These methods are used to predict the runoff response from given rainfall information and site surface characteristic conditions. The design storm frequencies used in all of the hydrologic engineering calculations will be based on design storms required in this guidebook unless circumstances make consideration of another storm intensity criterion appropriate:

- Urban Hydrology for Small Watersheds TR-55 (TR-55)
- Storage-Indication Routing
- HEC-1, WinTR-55, TR-20, and SWMM Computer Models
- Rational Method (limited to sites under five acres)

These methods are given as valid in principle, and are applicable to most stormwater management design situations in the District. Other methods may be used when the District reviewing authority approves their application.

Note: Of the above methods, TR-55 and SWMM allow for the easiest correlation of the benefits of retention BMPs used to meet the SWRV with peak flow detention requirements, and are therefore strongly recommended. Appendix A includes more information on using the Stormwater Compliance Spreadsheet to account for retention BMPs in calculating peak flow detention requirements.

The following conditions should be assumed when developing pre-development, pre-project, and post-development hydrology, as applicable:

- Pre-development runoff conditions (used for the 2-year storm) shall be computed independent of existing developed land uses and conditions and shall be based on “Meadow in good condition” or better, assuming good hydrologic conditions and land with grass cover.
- Pre-project runoff conditions (used for the 15-year storm) shall be based on the existing condition of the site
- Post-development shall be computed for future land use assuming good hydrologic and appropriate land use conditions. If a NRCS CN Method-based approach, such as TR-55, is used, this curve number may be reduced based upon the application of retention BMPs, as indicated in the Stormwater Compliance Spreadsheet (see Appendix A). This curve number reduction will reduce the required detention volume for a site, but it should not be used to reduce the size of conveyance infrastructure.

- The rainfall intensity - duration - frequency curve should be determined from the most recent version of the Hydrometeorological Design Studies Center's Precipitation Frequency Data Server (NOAA Atlas 14, Volume 2). <http://hdsc.nws.noaa.gov/hdsc/pfds/index.html>
- Pre-development time of concentration shall be based on the sum total of computed or estimated overland flow time and travel in natural swales, streams, creeks and rivers, but never less than six minutes.
- Post-development time of concentration shall be based on the sum total of the inlet time and travel time in improved channels or storm drains, but shall not be less than six minutes.
- Drainage areas exceeding 25 acres that are heterogeneous with respect to land use, RCN or Time of Concentration (Tc) shall require a separate hydrological analysis for each sub-area including Tc, RCN, soils and land use.
- Hydrologic Soil Groups approved for use in the District are contained in the Soil Survey of the District of Columbia Handbook. Where the Hydrologic Soil Group is not available through the Soil Survey due to the listed soil type being "Urban Soils" or similar, a Hydrologic Soil Group of C shall be used.

## **H.2 Urban Hydrology for Small Watersheds TR-55**

Chapter 6 of Urban Hydrology for Small Watersheds TR-55, Storage Volume for Detention Basins, or TR-55 shortcut procedure, is based on average storage and routing effects for many structures, and can be used for multistage outflow devices. Refer to TR-55 for more detailed discussions and limitations.

### **Information Needed**

To calculate the required storage volume using TR-55, the pre-development hydrology for the 2-year storm, and the pre-project hydrology for the 15-year storm are needed, along with post-development hydrology for both the 2-year and 15-year storms. The pre-development hydrology for the 2-year storm is based on natural conditions (meadow), and will determine the site's pre-development peak rate of discharge, or allowable release rate,  $q_{o2}$ , for the 2-year storm, where as the pre-project hydrology for the 15-year storm is based on existing conditions, and will determine the site's pre-project peak rate of discharge, or allowable release rate,  $q_{o15}$ , for the 15-year storm.

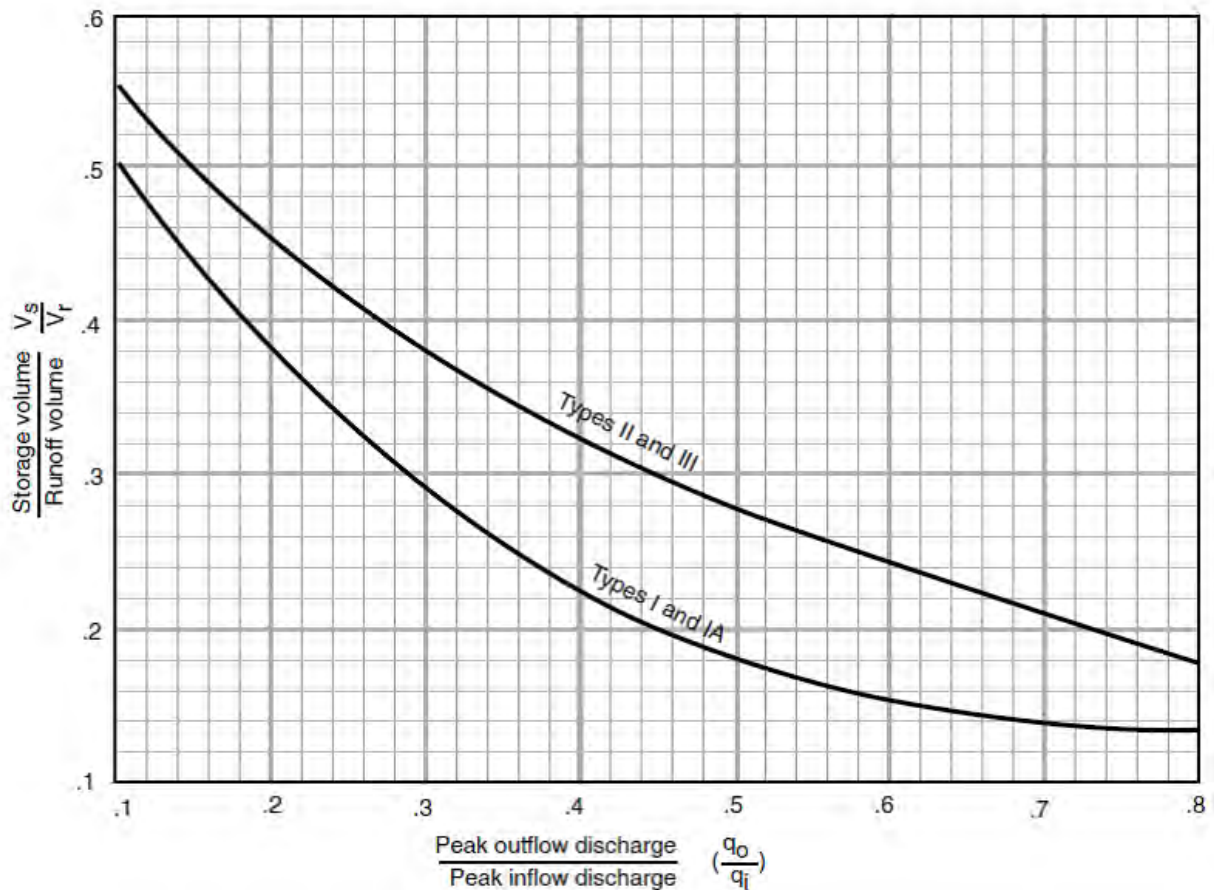
The post-development hydrology may be determined using the reduced curve numbers calculated in the Stormwater Compliance Spreadsheet (See Appendix A) or more detailed routing calculations. This will determine the site's post-development peak rate of discharge, or inflow for both the 2-year and 15-year storms,  $q_{i2}$  and  $q_{i15}$ , respectively, and the site's post-developed runoff,  $Q_2$  and  $Q_{15}$ , in inches. (Note that this method does not require a hydrograph.) Once the above parameters are known, the TR-55 Manual can be used to approximate the storage volume required for each design storm. The following procedure summarizes the TR-55 shortcut method.



**Procedure**

1. Determine the peak development inflows,  $q_{i2}$  and  $q_{i15}$ , and the allowable release rates,  $q_{o2}$  and  $q_{o15}$ , from the hydrology for the appropriate design storm.

Using the ratio of the allowable release rate,  $q_o$ , to the peak developed inflow,  $q_i$ , or  $q_o/q_i$ , for both the 2-year and 15-year design storms, use Figure H.1 (or Figure 6.1 in TR-55) to obtain the ratio of storage volume,  $V_s$ , to runoff volume,  $V_r$ , or  $V_{s2}/V_{r2}$  and  $V_{s15}/V_{r15}$  for Type II storms.



**Figure H.1** Approximate detention basin routing for rainfall types I, IA, II and III.

2. Determine the runoff volumes,  $V_{r2}$  and  $V_{r15}$ .

$$V_{r2} = 53.33 \times Q_2 \times Am$$

where:

- 53.33 = conversion factor from in-mi<sup>2</sup> to acre-feet
- $Q_2$  = post-development runoff, in inches for the 2-year storm
- $Am$  = drainage area, in square miles

$$Vr_{15} = 53.33 \times Q_{15} \times Am$$

where:

- 53.33 = conversion factor from in-mi<sup>2</sup> to acre-feet
- $Q_{15}$  = post-development runoff for the 15-year storm (in.)
- $Am$  = drainage area (mi<sup>2</sup>)

3. Multiply the  $V_s / V_r$  ratios from Step 1 by the runoff volumes,  $Vr_2$  and  $Vr_{15}$ , from Step 2, to determine the required storage volumes,  $Vs_2$  and  $Vs_{15}$ , in acre-feet.

$$\left(\frac{Vs_2}{Vr_2}\right)Vr_2 = Vs_2$$

$$\left(\frac{Vs_{15}}{Vr_{15}}\right)Vr_{15} = Vs_{15}$$

Note: In most cases,  $Vs_{15}$  represents the total storage required for the 2-year storm and the 15-year storm, and the outflow,  $q_{o15}$ , includes the outflow  $q_{o2}$ . In some cases,  $Vs_{15}$  may be less than  $Vs_2$ . In these cases, the storage volume provided for the 2-year storm ( $Vs_2$ ) may or may not be sufficient to meet the 15-year requirements, and must be checked via stage-storage curve analysis.

The design procedure presented above may be used with Urban Hydrology for Small Watersheds TR-55 Worksheet 6a. The worksheet includes an area to plot the stage-storage curve, from which actual elevations corresponding to the required storage volumes can be derived. The characteristics of the stage-storage curve are dependent upon the topography of the proposed storage practice and the outlet structure design (see Appendix G), and may be best developed using a spreadsheet or appropriate hydraulics software.

### Limitations

This routing method is less accurate as the  $q_o/q_i$  ratio approaches the limits shown in Figure H.1. The curves in Figure H.1 depend on the relationship between available storage, outflow device, inflow volume, and shape of the inflow hydrograph. When storage volume ( $V_s$ ) required is small, the shape of the outflow hydrograph is sensitive to the rate of the inflow hydrograph. Conversely, when  $V_s$  is large, the inflow hydrograph shape has little effect on the outflow hydrograph. In such instances, the outflow hydrograph is controlled by the hydraulics of the

outflow device and the procedure therefore yields consistent results. When the peak outflow discharge ( $q_o$ ) approaches the peak flow discharge ( $q_i$ ) parameters that affect the rate of rise of a hydrograph, such as rainfall volume, curve number, and time of concentration, become especially significant.

The procedure should not be used to perform final design if an error in storage of 25 percent cannot be tolerated. Figure H.1 is biased to prevent undersizing of outflow devices, but it may significantly overestimate the required storage capacity. More detailed hydrograph development and storage indication routing will often pay for itself through reduced construction costs.

### **H.3 Storage-Indication Routing**

Storage-Indication Routing may be used to analyze storage detention practices. This approach requires that the inflow hydrograph be developed through one of the methods listed in this appendix (TR-55, WinTR-55, SWMM, etc.), as well as the required maximum outflows,  $q_{o2}$  and  $q_{o15}$ . Using the stage-discharge relationship for a given combination outlet devices, the detention volume necessary to achieve the maximum outflows can be determined.

### **H.4 HEC-1, WinTR-55, TR-20, and SWMM Computer Models**

If the application of the above computer models is needed, the complete input data file and printout will be submitted with the stormwater management plans at the 85 percent submittal stage. Submission of stormwater management plans shall include the following computer model documentation:

- For all computer models, supporting computations prepared for the data input file shall be submitted with the stormwater management plans.
- Inflow-outflow hydrographs shall be computed for each design storm presented graphically, and submitted for all plans.
- Schematic (node) diagrams must be provided for all routings.

### **H.5 Rational Method**

While this method is not recommended, as it cannot account for the retention/detention benefits of the BMPs applied on a site, this method will be permitted for use in a development of five acres or less. When applying this method, the following steps must be taken in the design consideration:

- In the case of more than one sub-drainage area, the longest time of concentration shall be selected.
- Individual sub-drainage flows shall not be summed to get the total flow for the watershed.
- The runoff coefficient,  $C$ , shall be a composite of the future site development conditions for all contributing areas to the discharge point. Runoff coefficient factors for typical District land uses are provided in Table H.1.

- The flow time in storm sewers shall be taken into account in computing the watershed time of concentration.
- The storm duration shall be dependent upon the watershed time of concentration.
- The storm intensity can be selected from the selected storm duration.

**Table H.1 Runoff Coefficient Factors for Typical District of Columbia Land Uses**

Zone	Predominant Use	Minimum Lot Dimensions		Runoff Coefficient C
		Width (ft)	Area (ft <sup>2</sup> )	
R-1-A	One-family detached dwelling	75	7,500	0.60
R-1-B	One-family detached dwelling	50	5,000	0.65
R-2	One-family semi-detached dwelling	30	3,000	0.65
R-3	Row dwelling	20	2,000	0.70
R-4	Row dwelling	18	1,800	0.75
R-5-A	Low density apartment	–	–	0.70
R-5-B	Medium density apartment house	–	–	0.75
R-5-C	Medium high density apartment house	–	–	0.80
R-5-D	High density building	–	–	0.80
C	Commercial	–	–	0.85–0.95
M	General Industry	–	–	0.80–0.90
Park	Open green space	–	–	0.35

## H.6 Stormwater Retention Volume Peak Discharge

The peak rate of discharge for individual design storms may be required for several different components of water quality BMP design. While the primary design and sizing factor for most stormwater retention BMPs is the design Stormwater Retention Volume (SWRv), several design elements will require a peak rate of discharge for specified design storms. The design and sizing of pretreatment cells, level spreaders, by-pass diversion structures, overflow riser structures, grass swales and water quality swale geometry, etc., all require a peak rate of discharge in order to ensure non-erosive conditions and flow capacity.

The peak rate of discharge from a drainage area can be calculated from any one of several calculation methods discussed in this appendix. The two most commonly used methods of computing peak discharges for peak runoff calculations and drainage system design are NRCS

TR-55 Curve Number (CN) methods (NRCS TR-55, 1986) and the Rational Formula. The Rational Formula is highly sensitive to the time of concentration and rainfall intensity, and therefore should only be used with reliable Intensity-Duration-Frequency (IDF) curves or tables for the rainfall depth and region of interest (Claytor and Schueler, 1996). Unfortunately, there are no IDF curves available at this time for the 1.2-inch rainfall depth.

The NRCS CN methods are very useful for characterizing complex sub-watersheds and drainage areas and estimating the peak discharge from large storms (greater than two inches), but can significantly under estimate the discharge from small storm events (Claytor and Schueler, 1996). Since the  $T_v$  is based on a one-inch rainfall, this underestimation of peak discharge can lead to undersized diversion and overflow structures, potentially bypassing a significant volume of the design SWR<sub>v</sub> around the retention practice. Undersized overflow structures and outlet channels can cause erosion of the BMP conveyance features which can lead to costly and frequent maintenance, gnashing of teeth, and unacceptable levels of misery and despair.

In order to maintain consistency and accuracy, the following Modified CN Method is recommended to calculate the peak discharge for the SWR<sub>v</sub> 1.2-inch rain event. The method utilizes the Small Storm Hydrology Method (Pitt, 1994) and NRCS Graphical Peak Discharge Method (USDA 1986) to provide an adjusted curve number that is more reflective of the runoff volume from impervious areas within the drainage area. The design rainfall is a NRCS type II distribution so the method incorporates the peak rainfall intensities common in the eastern United States, and the time of concentration is computed using the method outlined in TR-55.

The following provides a step by step procedure for calculating the Stormwater Retention Volume peak rate of discharge (Q):

**Step 1:** Calculate the adjusted curve number for the site or contributing drainage area.

The following equation is derived from the NRCS CN Method and is described in detail in the National Engineering Handbook Chapter 4: Hydrology (NEH-4), and NRCS TR-55 Chapter 2: Estimating Runoff:

$$CN = \left[ \frac{100_0}{10 + 5P + 1_0 Q_a - 1_0 (Q_a^2 + 1.2_5 Q_a P)^{0.5}} \right]$$

where:

- $C$  = adjusted curve number
- $P$  = rainfall (in.), (1.2 in.)
- $Q_a$  = runoff volume (watershed inches), equal to SWR<sub>v</sub> divided by drainage area

Note: When using hydraulic/hydrologic model for sizing a retention BMP or calculating the SWR<sub>v</sub> peak discharge (Q), designers must use this modified CN for the drainage area to generate runoff equal to the SWR<sub>v</sub> for the 1.2-inch rainfall event.

**Step 2:** Compute the site or drainage area Time of Concentration (T<sub>c</sub>).

TR-55 Chapter 3: Time of Concentration and Travel Time provides a detailed procedure for computing the T<sub>c</sub>.

**Step 3:** Calculate the Stormwater Retention Volume peak discharge ()

**Step 4:** The  $q_{pSWRv}$  is computed using the following equation and the procedures outlined in TR-55, Chapter 4: Graphical Peak Discharge Method. Designers can also use WinTR-55 or an equivalent TR-55 spreadsheet to compute  $q_{pSWRv}$ :

- Read initial abstraction ( $I_a$ ) from TR-55 Table 4.1 or calculate using
- Compute  $I_a/P$  ( $P = 1.0$ )
- Read the Unit Peak Discharge ( $q_u$ ) from exhibit 4-II using  $T_c$  and  $I_a/P$
- Compute the  $Q_{Tv}$  peak discharge:

$$q_{pSWRv} = q_u \times A \times Q_a$$

where:

$$\begin{aligned} q_{pSWRv} &= \text{Stormwater Retention Volume peak discharge (cfs)} \\ q_u &= \text{unit peak discharge (cfs/mi}^2\text{/in.)} \\ A &= \text{drainage area (mi}^2\text{)} \\ Q_a &= \text{runoff volume (watershed inches = } SWRv/A \text{)} \end{aligned}$$

This procedure is for computing the peak flow rate for the 1.2-inch rainfall event. All other calculations of peak discharge from larger storm events for the design of drainage systems, culverts, etc., should use published curve numbers and computational procedures.

## H.7 References

- Claytor, R. and T. Schueler. 1996. Design of Stormwater Filtering Systems. Chesapeake Research Consortium and the Center for Watershed Protection. Ellicott City, MD.  
<http://www.cwp.org/online-watershed-library?view=docman>
- Pitt, R., 1994, Small Storm Hydrology. University of Alabama - Birmingham. Unpublished manuscript. Presented at design of stormwater quality management practices. Madison, WI, May 17-19 1994.
- United States Department of Agriculture Natural Resources Conservation Service Urban Hydrology for Small Watersheds TR-55. June 1986.
- Virginia Department of Conservation and Recreation DRAFT 2009 Virginia Stormwater Management Handbook. September 2009.

# Appendix I      Rooftop Storage Design Guidance and Criteria

## I.1      Rooftop Storage Design Guidance and Criteria

Note: Rooftop storage, as described in this Appendix, is intended as a detention practice only. The rules and guidelines presented in this Appendix do not apply to green roofs (Section 3.2).

1. Rooftop storage may be used to provide detention for the 2-year and 15-year storms, as applicable. Detention calculations must follow the procedures identified in Chapter 2 and Appendix H.
2. Rainfall from the 2-year, 24-hour storm results in an accumulated rainfall of approximately 3.2 inches, and rainfall from the 15-year, 24-hour storm results in an accumulated rainfall of approximately 5.2 inches. Peak flow detention calculations for either of these storms will require less than these depths (assuming there is no run-on from other rooftop areas).
  - (a) Based on a snow load of 30 pounds per square foot or 5.8 inches of water, properly designed roofs must be structurally capable of holding the required detention volume with a reasonable factor of safety.
  - (b) Roofs calculated to store depths greater than three inches shall be required to show structural adequacy of the roof design.
3. No less than two roof drains shall be installed in roof areas of 10,000 square feet or less, and at least four drains shall be installed in roof areas over 10,000 square feet in area. Roof areas exceeding 40,000 square feet shall have one drain for each 10,000 square foot area.
4. Emergency overflow measures adequate to discharge the 100-year, 45-minute storm must be provided.
  - (a) If parapet walls exceed 5 inches in height, the designer shall provide openings (scuppers) in the parapet wall sufficient to discharge the design storm flow at a water level not exceeding 5 inches.
  - (b) One scupper shall be provided for every 20,000 square feet of roof area, and the invert of the scupper shall not be more than 5 inches above the roof level. (If such openings are not practical, then detention rings shall be sized accordingly).
5. Detention rings shall be placed around all roof drains that do not have controlled flow.
  - (a) The number of holes or size of openings in the rings shall be computed based on the area of roof drained and run-off criteria.
  - (b) The minimum spacing of sets of holes is 2 inches center-to-center.
  - (c) The height of the ring is determined by the roof slope and detention requirements, and shall be 5 inches maximum.

- (d) The diameter of the rings shall be sized to accommodate the required openings and, if scuppers are not provided, to allow the 100-year design storm to overtop the ring (overflow design is based on weir computations with the weir length equal to the circumference of the detention ring).
  - (e) Conductors and leaders shall also be sized to pass the expected flow from the 100-year design storm.
6. The maximum time of drawdown on the roof shall not exceed 17 hours.
  7. Josam Manufacturing Company and Zurn Industries, Inc. market “controlled-flow” roof drains. These products, or their equivalent, are acceptable.
  8. Computations required on plans:
    - (a) Roof area in square feet.
    - (b) Storage provided at design depth.
    - (c) Maximum allowable discharge rate.
    - (d) Inflow-outflow hydrograph analysis or acceptable charts (for Josam Manufacturing Company and Zurn Industries, Inc. standard drains, the peak discharge rates as given in their charts are acceptable for drainage calculation purposes without requiring full inflow-outflow hydrograph analysis).
    - (e) Number of drains required.
    - (f) Sizing of openings required in detention rings.
    - (g) Sizing of ring to accept openings and to pass 100-year design storm.



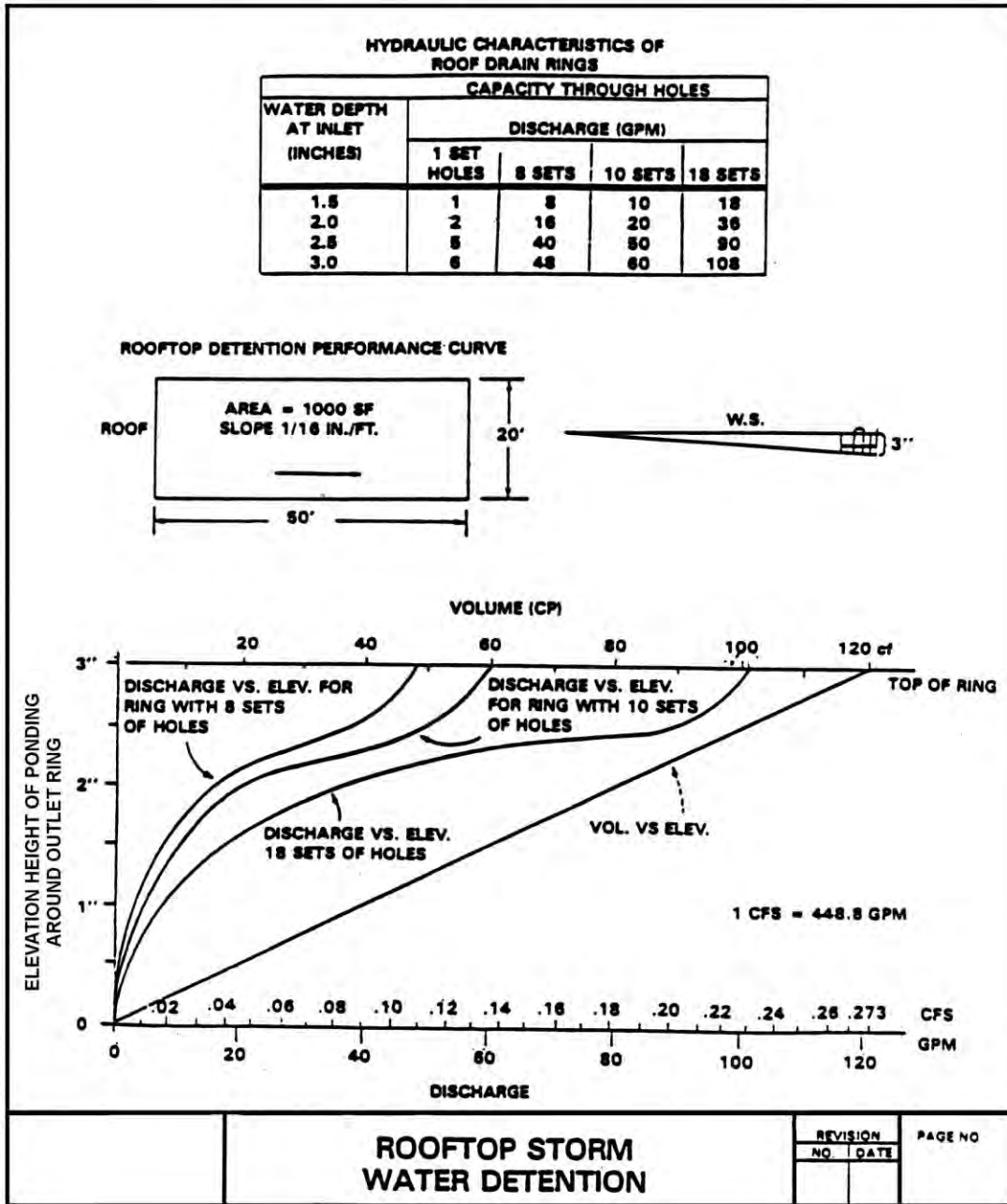


Figure I.1 Rooftop stormwater detention.

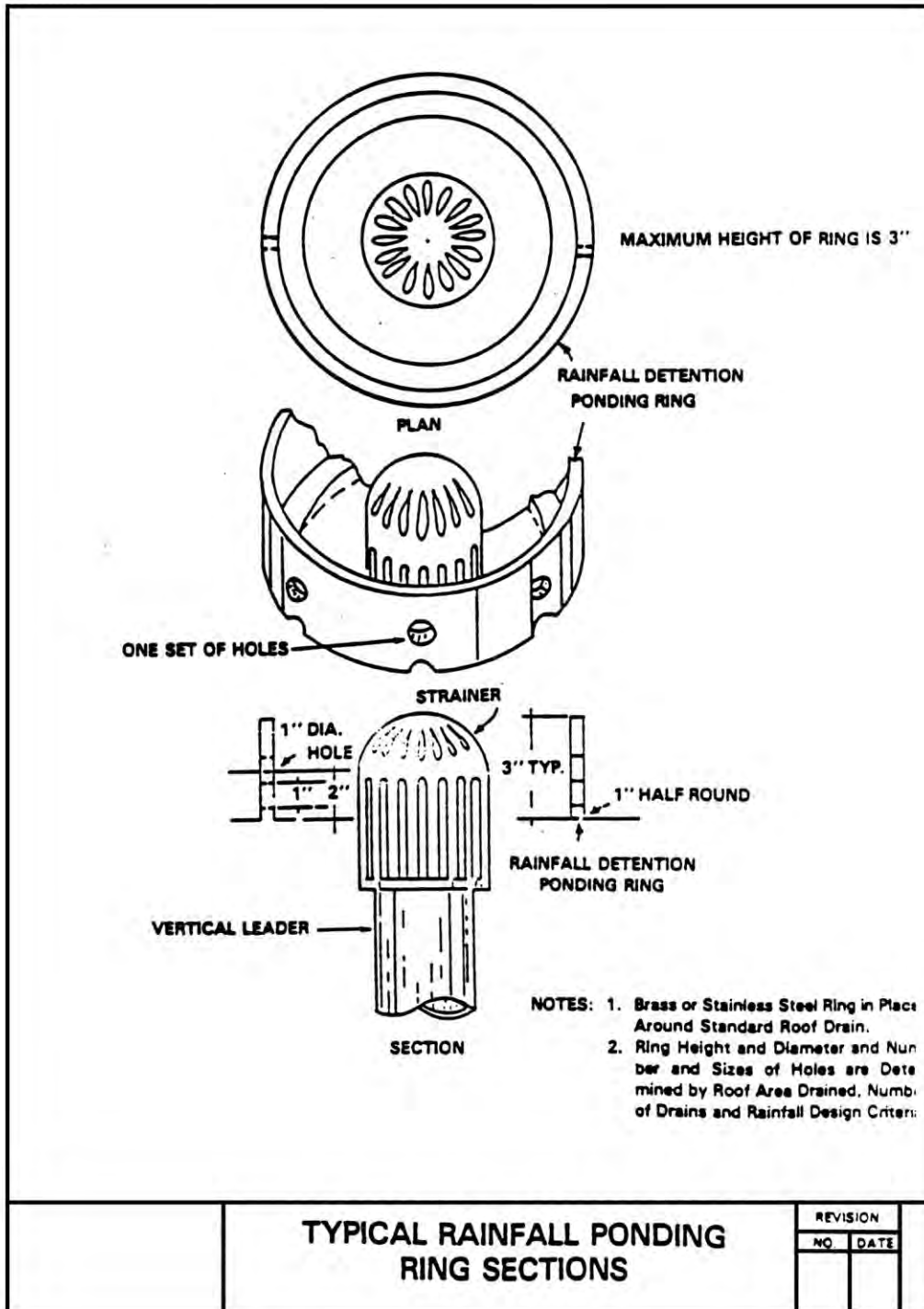


Figure I.2 Typical rainfall ponding ring sections.

# **Appendix J      Reserved**

The appendix on the Green Area Ratio (GAR) was removed. Guidance on the GAR will be through separate guidance documents available on DDOE's website when the GAR Rule is finalized.



# Appendix K      Soil Compost Amendment Requirements

Soil amendment (also called soil restoration) is a technique applied after construction to deeply till compacted soils and restore their porosity by amending them with compost. These soil amendments can be used to enhance the performance of impervious cover disconnections and grass channels.

## K.1 Physical Feasibility and Design Applications

Amended soils are suitable for any pervious area where soils have been or will be compacted by the grading and construction process. They are particularly well suited when existing soils have low infiltration rates (HSG C and D) and when the pervious area will be used to filter runoff (downspout disconnections and grass channels). The area or strip of amended soils should be hydraulically connected to the stormwater conveyance system. Soil restoration is recommended for sites that will experience mass grading of more than a foot of cut and fill across the site.

Compost amendments are not recommended where:

- Existing soils have high infiltration rates (e.g., HSG A and B), although compost amendments may be needed at mass-graded B soils in order to maintain infiltration rates.
- The water table or bedrock is located within 1.5 feet of the soil surface.
- Slopes exceed 10 percent (compost can be used on slopes exceeding 10 percent as long as proper erosion and sediment control measures are included in the plan).
- Existing soils are saturated or seasonally wet.
- They would harm roots of existing trees (keep amendments outside the tree drip line).
- The downhill slope runs toward an existing or proposed building foundation.
- Areas that will be used for snow storage.

## K.2 Design Criteria

**Performance.** When Used in Conjunction with Other Practices. As referenced in several of the Chapter 3 specifications, soil compost amendments can be used to enhance the performance of allied practices by improving runoff infiltration. The specifications for each of these practices contain design criteria for how compost amendments can be incorporated into those designs:

- Impermeable Surface Disconnection – See Section 3.4 Impervious Surface Disconnection.
- Grass Channels –See Section 3.9 Open Channel Systems.

**Soil Testing.** Soil tests are required during two stages of the compost amendment process. The first testing is done to ascertain preconstruction soil properties at proposed amendment areas.

The initial testing is used to determine soil properties to a depth 1 foot below the proposed amendment area, with respect to bulk density, pH, salts, and soil nutrients. These tests should be conducted every 5000 square feet, and are used to characterize potential drainage problems and determine what, if any, further soil amendments are needed.

The second soil test is taken at least one week after the compost has been incorporated into the soils. This soil analysis should be conducted by a reputable laboratory to determine whether any further nutritional requirements, pH adjustment, and organic matter adjustments are necessary for plant growth. This soil analysis must be done in conjunction with the final construction inspection to ensure tilling or subsoiling has achieved design depths.

**Determining Depth of Compost Incorporation.** The depth of compost amendment is based on the relationship of the surface area of the soil amendment to the contributing area of impervious cover that it receives. Table K.1 presents some general guidance derived from soil modeling by Holman-Dodds (2004) that evaluates the required depth to which compost must be incorporated. Some adjustments to the recommended incorporation depth were made to reflect alternative recommendations of Roa Espinosa (2006), Balousek (2003), Chollak and Rosenfeld (1998) and others.

**Table K.1 Method to Determine Compost and Incorporation Depths**

Ratio of Area of Contributing Impervious Cover to Soil Amendment <sup>a</sup> (IC/SA)	Compost Depth <sup>b</sup> (in.)	Incorporation Depth (in.)	Incorporation Method
0.5	3–6 <sup>c</sup>	8–12 <sup>c</sup>	Tiller
0.75	4–8 <sup>c</sup>	15–18 <sup>c</sup>	Subsoiler
1.0 <sup>d</sup>	6–10 <sup>c</sup>	18–24 <sup>c</sup>	Subsoiler

Notes:

<sup>a</sup> IC = contrib. impervious cover (ft<sup>2</sup>) and SA = surface area of compost amendment (ft<sup>2</sup>)

<sup>b</sup> Average depth of compost added

<sup>c</sup> Lower end for B soils, higher end for C/D soils

<sup>d</sup> In general, IC/SA ratios greater than 1 should be avoided

Once the area and depth of the compost amendments are known, the designer can estimate the total amount of compost needed, using an estimator developed by TCC, (1997):

$$C = A \times D \times 0.0031$$

where:

- C* = compost needed (yd<sup>3</sup>)
- A* = area of soil amended (ft<sup>2</sup>)
- D* = depth of compost added (in.)

**Compost Specifications.** The basic material specifications for compost amendments are outlined below:

- Compost shall be derived from plant material and provided by a member of the U.S. Composting Seal of Testing Assurance (STA) program. See [www.compostingcouncil.org](http://www.compostingcouncil.org) for a list of local providers.
- Alternative specifications and/or certifications, such as those administered by the Maryland Department of Agriculture or other agencies, may be substituted, as authorized by DDOE. In all cases, compost material must meet standards for chemical contamination and pathogen limits pertaining to source materials, as well as reasonable limits on phosphorus and nitrogen content to avoid excessive leaching of nutrients.
- The compost shall be the result of the biological degradation and transformation of plant-derived materials under conditions that promote anaerobic decomposition. The material shall be well composted, free of viable weed seeds, and stable with regard to oxygen consumption and carbon dioxide generation. The compost shall have a moisture content that has no visible free water or dust produced when handling the material. It shall meet the following criteria, as reported by the U.S. Composting Council STA Compost Technical Data Sheet provided by the vendor:
  - (a) 100 percent of the material must pass through a half-inch screen
  - (b) The pH of the material shall be between 6 and 8
  - (c) Manufactured inert material (plastic, concrete, ceramics, metal, etc.) shall be less than 1.0 percent by weight
  - (d) The organic matter content shall be between 35 and 65 percent
  - (e) Soluble salt content shall be less than 6.0 mmhos/cm
  - (f) Maturity must be greater than 80 percent
  - (g) Stability shall be 7 or less
  - (h) Carbon/nitrogen ratio shall be less than 25:1
  - (i) Trace metal test result = ~~pass~~
  - (j) The compost must have a dry bulk density ranging from 40 to 50 lb/ft<sup>3</sup>

### **K.3 Construction Sequence**

The construction sequence for compost amendments differs depending whether the practice will be applied to a large area or a narrow filter strip, such as in a rooftop disconnection or grass channel. For larger areas, a typical construction sequence is as follows:

**Step 1:** A deep tilling to a depth of 12 to 18 inches after final building lots have been graded is recommended prior to the addition of compost.

**Step 2:** It is important to have dry conditions at the site prior to incorporating compost.

**Step 3:** The required depth of compost (as indicated in Table K.1) is then incorporated into the soil to the required depth using appropriate equipment.

**Step 4:** The site should be leveled and seeds or sod used to establish a vigorous grass cover. Lime or irrigation may initially be needed to help the grass grow quickly.

**Step 5:** Areas of compost amendments exceeding 2500 square feet should employ simple erosion control measures, such as silt fence, to reduce the potential for erosion and trap sediment.

**Construction Inspection.** Construction inspection by a qualified professional involves digging a test pit to verify the depth of amended soil and scarification. A rod penetrometer should be used to establish the depth of uncompacted soil at a minimum of one location per 10,000 square feet.

## K.4 Maintenance

**First-Year Maintenance Operations.** In order to ensure the success of soil compost amendments, the following tasks must be undertaken in the first year following soil restoration:

- **Initial inspections.** For the first six months following the incorporation of soil amendments, the site should be inspected by a qualified professional at least once after each storm event that exceeds 1/2-inch of rainfall.
- **Spot Reseeding.** Inspectors should look for bare or eroding areas in the contributing drainage area or around the soil restoration area and make sure they are immediately stabilized with grass cover.
- **Fertilization.** Depending on the amended soils test, a one-time, spot fertilization may be needed in the fall after the first growing season to increase plant vigor.
- **Watering.** Water once every three days for the first month, and then weekly during the first year (April-October), depending on rainfall.

**Ongoing Maintenance.** There are no major ongoing maintenance needs associated with soil compost amendments, although the owners may want to de-thatch the turf every few years to increase permeability. The owner should also be aware that there are maintenance tasks needed for filter strips, grass channels, and reforestation areas. DDOE's maintenance inspection checklist for an area of Soil Compost Amendments can be accessed in Appendix M.

**Declaration of Covenants.** A maintenance covenant is required for all stormwater management practices. The covenant specifies the property owner's primary maintenance responsibilities, and authorizes DDOE staff to access the property for inspection or corrective action in the event the proper maintenance is not performed. The covenant is attached to the deed of the property (see standard form, variations exist for scenarios where stormwater crosses property lines). The covenant is between the property and the District Government. It is submitted through the Office of the Attorney General. All SWMPs have a maintenance agreement stamp that must be signed for a building permit to proceed. There may be a maintenance schedule on the drawings themselves or the plans may refer to the maintenance schedule (schedule c in the covenant).

Covenants are not required on government properties, but maintenance responsibilities must be defined through a partnership agreement or a memorandum of understanding.



## **K.5 References**

- Balusek. 2003. Quantifying decreases in stormwater runoff from deep-tilling, chisel-planting and compost amendments. Dane County Land Conservation Department. Madison, Wisconsin.
- Chollak, T. and P. Rosenfeld. 1998. Guidelines for Landscaping with Compost-Amended Soils. City of Redmond Public Works. Redmond, WA. Available online at: [www.redmond.gov/common/pages/UserFile.aspx?fileId=14766](http://www.redmond.gov/common/pages/UserFile.aspx?fileId=14766)
- The Composting Council (TCC). 1997. Development of a Landscape Architect Specification for Compost Utilization. Alexandria, VA. <http://www.cwc.org/organics/org972rpt.pdf>
- Holman-Dodds, L. 2004. Chapter 6. Assessing Infiltration-Based Stormwater Practices. PhD Dissertation. Department of Hydroscience and Engineering. University of Iowa. Iowa City, IA.
- Low Impact Development Center. 2003. Guideline for Soil Amendments. Available online at: <http://www.lowimpactdevelopment.org/epa03/soilamend.htm>
- Roa-Espinosa. 2006. An Introduction to Soil Compaction and the Subsoiling Practice. Technical Note. Dane County Land Conservation Department. Madison, Wisconsin.



# Appendix L Construction Inspection Checklists

Inspections before, during and after construction are required to ensure that SWMPs are built in accordance with the approved plan specifications. Inspectors will use detailed inspection checklists that require sign-offs by qualified individuals at critical stages of construction to ensure the contractor's interpretation of the plan is consistent with the designer's intent.

This appendix includes the following construction phase inspection checklists:

<b>Practice Type</b>	<b>Page</b>
Green Roof Construction Inspection	L-5
Rainwater Harvesting Construction Inspection	L-8
Impervious Cover Disconnection Construction Inspection	L-10
Permeable Pavement Construction Inspection	L-12
Bioretention Construction Inspection	L-14
Filtering System Construction Inspection	L-16
Infiltration Facility Construction Inspection	L-18
Open Channel Construction Inspection	L-20
Ponds, Wetland, and Storage Facility Construction Inspection	L-22
Tree Planting and Preservation Construction Inspection	L-24
Generic Stormwater Management Facility Construction Inspection	L-26
Stormwater Facility Leak Test	L-28

Inspections before, during and after construction are required to ensure that SWMPs are built in accordance with the approved plan specifications. Inspectors will use detailed inspection checklists that require sign-offs by qualified individuals at critical stages of construction to ensure the contractor's interpretation of the plan is consistent with the designer's intent.

This appendix includes the following construction phase inspection checklists:

<b>Practice Type</b>	<b>Page</b>
Green Roof Construction Inspection	L-5
Rainwater Harvesting Construction Inspection	L-8
Impervious Cover Disconnection Construction Inspection	L-10
Permeable Pavement Construction Inspection	L-12
Bioretention Construction Inspection	L-14
Filtering System Construction Inspection	L-16
Infiltration Facility Construction Inspection	L-18
Open Channel Construction Inspection	L-20
Ponds, Wetland, and Storage Facility Construction Inspection	L-22
Tree Planting and Preservation Construction Inspection	L-24
Generic Stormwater Management Facility Construction Inspection	L-26
Stormwater Facility Leak Test	L-28

This Page Intentionally Left Blank



**GOVERNMENT OF THE DISTRICT OF COLUMBIA**  
**DISTRICT DEPARTMENT OF THE ENVIRONMENT**  
**WATERSHED PROTECTION DIVISION**  
**INSPECTION AND ENFORCEMENT BRANCH**  
**Green Roof Construction Inspection Report**

Building Permit # \_\_\_\_\_ Plan # \_\_\_\_\_ Lot: \_\_\_\_\_ Square: \_\_\_\_\_

Project Name and Address: \_\_\_\_\_ Ward: \_\_\_\_\_

Contractor: \_\_\_\_\_ Telephone # \_\_\_\_\_

Engineer: \_\_\_\_\_ Telephone # \_\_\_\_\_

Date Started: \_\_\_\_\_ Final Inspection Date: \_\_\_\_\_

Green Roof Type: Extensive \_\_ Intensive \_\_ New Construction \_\_ Retrofit of Existing Roof \_\_

If this is a Retrofit Green Roof Attach a Copy of the Roof Structural Certification \_\_

As-Built Plan Due Date: \_\_\_\_\_



Appendix L Construction Inspection Checklists

Inspection Item	No	Yes	Remarks	Date
<p><b>Deck Preparation :</b></p> <p>Is the deck free of all trash, debris, grease, oil, water and moisture?</p> <p>Are all concrete surfaces properly cured, dry and free of voids, cracks, or holes?</p> <p>For <b>retrofitted</b> roofs are all existing membranes and flashing removed to the bare concrete or deck?</p> <p>Are all expansion joints free of broken edges or loose aggregate and sealed to a depth at least twice as wide as the joint?</p> <p>Is a leak detection device installed? <i>(include manufacturer and testing information)</i></p>				
<p><b>Water Proofing:</b></p> <p>Certification: identify type: Hot or Cold applied?</p> <p>Does the waterproofing system require an applicator –certified” by the manufacturer? <i>(attach certifications)</i></p> <p>Are site conditions appropriate for application of water proofing materials? <i>(note temperature and moisture conditions)</i></p> <p>Have the correct number of water proofing layers been installed as per the approved green roof plan?</p> <p>Does the membrane reinforcement and flashing meet plan specifications? <i>(attach invoice and/or manufactures certifications)</i></p> <p>Is protection provided for water proofing membrane? <i>(specify membrane type, indicate the duration between installation of membrane and media)</i></p>				
<p><b>Water Test:</b></p> <p>Has a water test been conducted? Verify the water test is conducted according to test standards demonstrating two inches of water ponding for a 24- 48 hour period. <i>(attach water test report)</i></p>				

**GOVERNMENT OF THE DISTRICT OF COLUMBIA**  
**DISTRICT DEPARTMENT OF THE ENVIRONMENT**  
**WATERSHED PROTECTION DIVISION**  
**INSPECTION AND ENFORCEMENT BRANCH**  
**Green Roof Construction Inspection Report--Continued**

Project Name and Address: \_\_\_\_\_ File and WPD No \_\_\_\_\_

Inspection Item	No	Yes	Remarks	Date
<p><b>Green Roof Components:</b>            Do the <b>over flow drains</b> meet plan specifications?            Verify dimensions, materials and locations.</p> <p>Do <b>drain boxes, vent pipes and other penetrations</b> meet plan specifications? Verify locations, water proofing details, flashing details and finish details. Verify materials selection and construction.</p> <p>Identify if this is a tray system or a built in place system.</p> <p>Do the <b>root barrier, insulation, moisture retention layer, filter fabric, and drainage layers</b> meet plan specifications? (<i>attach invoice and manufactures' certifications</i>)</p> <p>Does the <b>growing media</b> meet plan specifications? Verify depth of growing material. (<i>attach invoice and manufactures' certifications</i>)</p> <p>Does the <b>vegetation layer</b> meet plan specifications? Verify <b>vegetation source—plugs, seeds, pre grown mat, species mixture, coverage.</b> (<i>attach invoice and laboratory certification</i>)</p> <p>Does the <b>metal curbing and flashing</b> meet plan specifications (<i>attach invoice and manufactures' certifications</i>)?</p> <p>Are all <b>seams, joints and edges</b> caulked and sealed with approved grade of caulk or sealant (<i>Attach Invoice</i>)?</p> <p>Do <b>pedestals and pavers</b> and non -vegetated areas meet plan specifications (type, and location)?</p>				



**GOVERNMENT OF THE DISTRICT OF COLUMBIA**  
**DISTRICT DEPARTMENT OF THE ENVIRONMENT**  
**WATERSHED PROTECTION DIVISION**  
**INSPECTION AND ENFORCEMENT BRANCH**  
**Green Roof Construction Inspection Report--Continued**

Project Name and Address: \_\_\_\_\_ File and WPD No \_\_\_\_\_

Inspection Item	No	Yes	Remarks	Date
<p><b>Irrigation:</b></p> <p>Is there an irrigation system?</p> <p>Is the system installed to plan specifications?  Verify <b>water source, location, service access, and pressure.</b></p>				
<p><b>Plantings and Housekeeping:</b></p> <p>Modular System _Vegetated Mats _Plugs_ Other_</p> <p>Do plants meet size and variety specifications?</p> <p>Are all plants installed as per plan specifications?  Note the planting <b>distribution, the depth of media,</b> and whether or not <b>adequate watering</b> was provided.</p> <p>Is temporary netting or wind uplift protection required?</p> <p>Have all planting waste materials, and construction trash and debris been pickup and removed from the roof?</p>				

Contractor/Engineer \_\_\_\_\_ Inspector \_\_\_\_\_ Date \_\_\_\_\_

This Page Intentionally Left Blank



**GOVERNMENT OF THE DISTRICT OF COLUMBIA**  
**DISTRICT DEPARTMENT OF THE ENVIRONMENT**  
**WATERSHED PROTECTION DIVISION**  
**INSPECTION AND ENFORCEMENT BRANCH**  
**Rainwater Harvesting - Construction Inspection Report**

Building Permit # \_\_\_\_\_ Plan and File # \_\_\_\_\_ Lot: \_\_\_\_\_ Square: \_\_\_\_\_

Project Name and Address: \_\_\_\_\_ Ward: \_\_\_\_\_

Contractor: \_\_\_\_\_ Telephone # \_\_\_\_\_

Engineer: \_\_\_\_\_ Telephone # \_\_\_\_\_

Responsible For Maintenance: \_\_\_\_\_ Telephone # \_\_\_\_\_

Date Started: \_\_\_\_\_ Final Inspection Date: \_\_\_\_\_ As-Built Plan Due Date: \_\_\_\_\_

Inspection Items	Yes	No	Remarks	Date
<p><b>Subgrade Preparation:</b></p> <p>Has the subgrade been properly prepared and tank foundation installed as shown on plans?</p>				
<p><b>Contributing Drainage Area:</b></p> <p>Does the rooftop area draining to the tank match the plans?</p>				
<p><b>Conveyance and First Flush Diversion:</b></p> <p>Do the gutters meet specifications with the correct sizing, elevation, and slope?</p>				
<p>Is the first flush diversion system properly sized and installed?</p>				
<p>Are mosquito screens properly installed on all tank openings?</p>				
<p><b>Pump System (where Applicable):</b></p> <p>The pump and piping to end-uses (indoor, outdoor irrigation, or tank dewatering release) has been properly installed</p>				
<p><b>Overflow System:</b></p> <p>Overflow device is directed as shown on plans</p>				
<p>Catchment area and overflow area are stabilized</p>				
<p>Secondary stormwater treatment practice(s) (if applicable) is installed as shown on plans</p>				
<p><b>Final Inspection:</b></p> <p>Is water conveyed into tank and to end-uses appropriately?</p>				

Owner/Agent \_\_\_\_\_ Inspector \_\_\_\_\_ Date \_\_\_\_\_

DDOE(WHITE)

OWNER/AGENT(YELLOW)

INSPECTOR (PINK)

This Page Intentionally Left Blank



**GOVERNMENT OF THE DISTRICT OF COLUMBIA**  
**DISTRICT DEPARTMENT OF THE ENVIRONMENT**  
**WATERSHED PROTECTION DIVISION**  
**INSPECTION AND ENFORCEMENT BRANCH**

**Impervious Cover Disconnection - Construction Inspection Report**

Building Permit # \_\_\_\_\_ Plan and File # \_\_\_\_\_ Lot: \_\_\_\_\_ Square: \_\_\_\_\_

Project Name and Address: \_\_\_\_\_ Ward: \_\_\_\_\_

Contractor: \_\_\_\_\_ Telephone # \_\_\_\_\_

Engineer: \_\_\_\_\_ Telephone # \_\_\_\_\_

Responsible For Maintenance: \_\_\_\_\_ Telephone # \_\_\_\_\_

Type of Disconnection: Simple \_\_\_\_\_ Dry Well \_\_\_\_\_ Rain Garden \_\_\_\_\_ Other \_\_\_\_\_

Date Started: \_\_\_\_\_ Final Inspection Date: \_\_\_\_\_ As-Built Plan Due Date: \_\_\_\_\_

Appendix L Construction Inspection Checklists

Inspection Items	Yes	No	Remarks	Date Completed
<b>Site Preparation:</b> Have erosion and sediment controls been properly installed and maintained according to approved plans?				
Do site excavation and grading conform to the site plans?				
Has the pervious receiving area avoided compaction during excavation?				
<b>Contributing Drainage Area:</b> Does the impervious area draining to the receiving pervious area match the plans?				
<b>Practice Geometry:</b> Does the receiving pervious area match the dimensions and slopes shown on the plan?				
Has a secondary practice been installed according to plan (if required)?				
<b>Vegetation:</b> Does the pervious area vegetation comply with the approved planting plan and specification?				
Topsoil mixture, soil amendments, and soil compaction comply with plan (if required)				
<b>Final Inspection:</b> Have the contributing impervious area and the receiving pervious area been stabilized?				
Can water flow properly into the receiving pervious area?				

Owner/Agent \_\_\_\_\_ Inspector \_\_\_\_\_ Date \_\_\_\_\_

DDOE(WHITE)

OWNER/AGENT(YELLOW)

INSPECTOR (PINK)

This Page Intentionally Left Blank





**GOVERNMENT OF THE DISTRICT OF COLUMBIA**  
**DISTRICT DEPARTMENT OF THE ENVIRONMENT**  
**WATERSHED PROTECTION DIVISION**  
**INSPECTION AND ENFORCEMENT BRANCH**  
**Permeable Pavement - Construction Inspection Report**

Building Permit # \_\_\_\_\_ Plan and File # \_\_\_\_\_ Lot: \_\_\_\_\_ Square: \_\_\_\_\_

Project Name and Address: \_\_\_\_\_ Ward: \_\_\_\_\_

Contractor: \_\_\_\_\_ Telephone # \_\_\_\_\_

Engineer: \_\_\_\_\_ Telephone # \_\_\_\_\_

Responsible For Maintenance: \_\_\_\_\_ Telephone # \_\_\_\_\_

Date Started: \_\_\_\_\_ Final Inspection Date: \_\_\_\_\_ As-Built Plan Due Date: \_\_\_\_\_

Inspection Items	Yes	No	Remarks	Date
<b>Site Preparation:</b>				
Have erosion and sediment controls been properly installed and maintained according to approved plans?				
Is stormwater runoff being diverted around the facility?				
Has the contributing drainage area been fully stabilized?				
<b>Subgrade Preparation:</b>				
Is subgrade suitable free of debris, standing water, proper grading				

Appendix L Construction Inspection Checklists

Inspection Items	Yes	No	Remarks	Date
If design is for infiltration, verify soils have not been compacted.				
Excavated soil stockpile is located away from facility with erosion and sediment controls in place?				
<p><b>Filter Layer or Geotextile Fabric (where Applicable):</b></p> <p>The filter layer and/or geotextile fabric have been installed according to the specifications.</p>				
<p><b>Underdrain and Reservoir Layer:</b></p> <p>Does the underdrain meet specifications with correct perforation pattern, elevation, and slope?</p>				
Caps are placed on the upstream (but not the downstream) ends of the underdrains				
Does the stone reservoir meet specifications (clean, washed, free of fines) and is it installed to design depth?				
Is at least 2 inches of aggregate provided above and below the underdrains?				
<p><b>Surface Material:</b></p> <p>Does the surface material meet the specification and has it been properly installed?</p>				
Is the surface even and can runoff spread evenly across it?				
Has the surface material had adequate curing time (for porous asphalt and pervious concrete)				
Is the surface free of fines and areas of clogging?				
<p><b>Over Flow Drain (where Applicable):</b></p> <p>Is overflow invert at correct elevation?</p>				
<p><b>Final Inspection:</b></p> <p>Can water infiltrate properly into the practice?</p>				
Does the reservoir storage layer drain within 48 hours?				

Owner/Agent \_\_\_\_\_ Inspector \_\_\_\_\_ Date \_\_\_\_\_

DDOE(WHITE)

OWNER/AGENT(YELLOW)

INSPECTOR (PINK)

This Page Intentionally Left Blank



**GOVERNMENT OF THE DISTRICT OF COLUMBIA**  
**DISTRICT DEPARTMENT OF THE ENVIRONMENT**  
**WATERSHED PROTECTION DIVISION**  
**INSPECTION AND ENFORCEMENT BRANCH**  
**Bioretention - Construction Inspection Report**

Building Permit # \_\_\_\_\_ Plan and File # \_\_\_\_\_ Lot: \_\_\_\_\_ Square: \_\_\_\_\_

Project Name and Address: \_\_\_\_\_ Ward: \_\_\_\_\_

Contractor: \_\_\_\_\_ Telephone # \_\_\_\_\_

Engineer: \_\_\_\_\_ Telephone # \_\_\_\_\_

Responsible For Maintenance: \_\_\_\_\_ Telephone # \_\_\_\_\_

Date Started: \_\_\_\_\_ Final Inspection Date: \_\_\_\_\_ As-Built Plan Due Date: \_\_\_\_\_

Inspection Items	Yes	No	Remarks	Date
<p><b>Inflow/Overflow:</b></p> <p>Is overflow invert at correct elevation?</p> <p>Is inflow pipe to filter plugged with watertight seal (prior to stabilization)?</p>				
<p><b>Basin and Impermeable Liner</b> (where applicable):</p>				

Appendix L Construction Inspection Checklists

---

Inspection Items	Yes	No	Remarks	Date
<p>Basin graded as per approved plan?</p> <p>Basin liner material and installation meets specification of approved plan? (attach labeled sample)</p>				
<p><b>Underdrains:</b></p> <p>Do collector pipes meet specifications with correct hole pattern? (attach materials invoice)</p> <p>Do collector stone and stone beneath sand meet specifications and is installed to design depth?</p>				
<p><b>Filter Media:</b></p> <p>Does filter media meet specifications? (attach lab report and material certification)</p> <p>Filter media installed to design depth and compacted on _____ (date) and refilled to designed depth?</p>				



**GOVERNMENT OF THE DISTRICT OF COLUMBIA**  
**DISTRICT DEPARTMENT OF THE ENVIRONMENT**  
**WATERSHED PROTECTION DIVISION**  
**INSPECTION AND ENFORCEMENT BRANCH**

**Bioretention Construction Inspection Report--Continued**

Project Name and Address: \_\_\_\_\_ File and WPD No \_\_\_\_\_

Inspection Item	No	Yes	Remarks	Date
<p><b>Bioretention Plant Materials:</b></p> <p>Do plants meet size and variety specifications?</p> <p>Are all plants installed as per landscape plan?</p> <p>Is mulch and cover crop installed as per plan specifications?</p> <p>Are plant/ trees staked as per specifications?</p> <p>Has watering of plant material been provided once a week during first two months for fourteen consecutive days after planting has been completed , then as needed during first growing season.?</p>				
<p><b>Observation Well Inlets:</b></p> <p>Is observation well free of construction debris and soil?</p>				

Appendix L Construction Inspection Checklists

Inspection Item	No	Yes	Remarks	Date
Is outflow pipe invert at the design elevation?				
<p><b>Notes:</b></p> <p>1. A qualified professional must treat disease plants.</p> <p>2. Deficient stakes and wires must be replaced.</p> <p>3. Dead plants or plants diseased beyond treatment must be replaced by plant meeting original specifications.</p> <p>3. New plants must be watered every day for the first 14 days after planting.</p>				

Owner/Agent \_\_\_\_\_ Inspector \_\_\_\_\_ Date \_\_\_\_\_

DDOE(WHITE)

OWNER/AGENT(YELLOW)

INSPECTOR (PINK)

Bioretention construction inspection 03/2011



**GOVERNMENT OF THE DISTRICT OF COLUMBIA**  
**DISTRICT DEPARTMENT OF THE ENVIRONMENT**  
**WATERSHED PROTECTION DIVISION**  
**INSPECTION AND ENFORCEMENT BRANCH**  
**Filtering System Construction Inspection Report**

Building Permit # \_\_\_\_\_ Plan # \_\_\_\_\_ Lot: \_\_\_\_\_ Square: \_\_\_\_\_

Project Name and Address: \_\_\_\_\_ Ward: \_\_\_\_\_

Contractor: \_\_\_\_\_ Telephone # \_\_\_\_\_

Engineer: \_\_\_\_\_ Telephone # \_\_\_\_\_

Date Started: \_\_\_\_\_ Final Inspection Date: \_\_\_\_\_

Structure Type: Cast in placed \_\_\_ Prefabricated \_\_\_ Name of Plant: \_\_\_\_\_

As-Built Plan Due Date: \_\_\_\_\_

---

Inspection Item	No	Yes	Remarks	Date
<b>Subgrade:</b>				
Is sub grade suitable? ( free of debris, standing water)				
Is a subgrade Suitability Certification provided?				



Appendix L Construction Inspection Checklists

Inspection Item	No	Yes	Remarks	Date
<p><b>Prefabricated Structure:</b></p> <p>Are shop drawings provided?</p> <p>Do type and location of openings meet specifications?</p>				
<p><b>Cast-In-Place Structure:</b></p> <p>Are structural drawings provided?</p> <p>Is a certification provided on steel placement?</p> <p>Provide load ticket showing concrete plant mix, strength certification, and load time.</p> <p>Is a certification provided for concrete placement?</p> <p>Do the 28 day break results meet design specifications?</p>				
<p><b>Access:</b></p> <p>Is access for each chamber provided? (manholes, doors, steps, ladder)</p>				
<p><b>Leak Test:</b></p> <p>Does the leak test meet specifications? (attach form)</p>				



**GOVERNMENT OF THE DISTRICT OF COLUMBIA**  
**DISTRICT DEPARTMENT OF THE ENVIRONMENT**  
**WATERSHED PROTECTION DIVISION**  
**INSPECTION AND ENFORCEMENT BRANCH**

**Filtering System Construction Inspection Report--Continued**

Project Name and Address: \_\_\_\_\_ File and WPD No \_\_\_\_\_

Inspection Item	No	Yes	Remarks	Date
<p><b>Inflow Chamber:</b></p> <p>Does the orifice/ submerged weir opening meet specifications of the approved plan? (dimensions)</p> <p>Is overflow/bypass installed per approved plan? (size, support, sealed)</p>				
<p><b>Filter Chamber :</b></p> <p>Is under drain installed per approved plan? (specifications, number size and spacing of holes )</p> <p>Is filter bed installed per approved plan? (specifications of sand, gravel and filter cloth) (attach materials invoice)</p>				

Appendix L Construction Inspection Checklists

---

Inspection Item	No	Yes	Remarks	Date
<p><b>Outflow Chamber:</b></p> <p>Dewatering valve installed per approved plan?</p> <p>Are perforated pipe openings installed?</p> <p>Sump pit required?</p>				
<p><b>Back Fill:</b></p> <p>Does backfill soil conform to specifications?</p> <p>Is a certification for lift, thickness and density test provided?</p>				

Owner/Agent \_\_\_\_\_ Inspector \_\_\_\_\_ Date \_\_\_\_\_

DDOE(WHITE)

OWNER/AGENT(YELLOW)

INSPECTOR (PINK)

Sand Filter construction inspection 03/2011



**GOVERNMENT OF THE DISTRICT OF COLUMBIA**  
**DISTRICT DEPARTMENT OF THE ENVIRONMENT**  
**WATERSHED PROTECTION DIVISION**  
**INSPECTION AND ENFORCEMENT BRANCH**  
**Infiltration Facility - Construction Inspection Report**

Building Permit # \_\_\_\_\_ Plan and File # \_\_\_\_\_ Lot: \_\_\_\_\_ Square: \_\_\_\_\_

Project Name and Address: \_\_\_\_\_ Ward: \_\_\_\_\_

Contractor: \_\_\_\_\_ Telephone # \_\_\_\_\_

Engineer: \_\_\_\_\_ Telephone # \_\_\_\_\_

Responsible For Maintenance: \_\_\_\_\_ Telephone # \_\_\_\_\_

Infiltration Device Type: Dry Well \_\_\_\_\_ Infiltration Trench \_\_\_\_\_ Infiltration Basin \_\_\_\_\_ Other \_\_\_\_\_

Date Started: \_\_\_\_\_ Final Inspection Date: \_\_\_\_\_ As-Built Plan Due Date: \_\_\_\_\_

Inspection Items	Yes	No	Remarks	Date Completed
<b>Site Preparation:</b>				
Have erosion and sediment controls been properly installed and maintained according to approved plans?				
Is stormwater runoff being diverted around the facility?				
Has the contributing drainage area been fully				

Appendix L Construction Inspection Checklists

Inspection Items	Yes	No	Remarks	Date Completed
stabilized?				
<b>Subgrade Preparation:</b> Is subgrade suitable? (free of debris, standing water, properly graded)				
Has compaction of the soils been avoided?				
Excavated soil stockpile is located away from facility with erosion and sediment controls in place?				
<b>Practice Bottom:</b> Has a 6 to 8 inch sand layer been installed beneath the practice according to the approved plans?				
<b>Geotextile Fabric:</b> Have the filter layer and/or geotextile fabric been installed on the sides of the practice <u>only</u> according to the specifications?				
<b>Stone Reservoir Layer:</b> Does the stone reservoir meet specifications (clean, washed, free of fines) and is it installed to design depth?				
<b>Surface Material:</b> Does the surface material meet the specification and has it been properly installed?				
Is the surface free of fines and areas of clogging?				



**GOVERNMENT OF THE DISTRICT OF COLUMBIA**  
**DISTRICT DEPARTMENT OF THE ENVIRONMENT**  
**WATERSHED PROTECTION DIVISION**  
**INSPECTION AND ENFORCEMENT BRANCH**

**Infiltration Facility Construction Inspection Report--Continued**

Project Name and Address: \_\_\_\_\_ File and WPD No \_\_\_\_\_

Inspection Item	No	Yes	Remarks	Date
<p><b>Pretreatment:</b></p> <p>Are the pretreatment facilities installed according to the approved plans?</p>				
<p><b>Over Flow (where Applicable):</b></p> <p>Is overflow invert at correct elevation?</p> <p>Has the outfall been constructed with adequate protection as specified on the plans?</p>				
<p><b>Final Inspection:</b></p> <p>Can water infiltrate properly into the practice?</p> <p>Does the practice include an observation well?</p> <p>Does the reservoir storage layer drains within 72 hours?</p>				

Owner/Agent \_\_\_\_\_ Inspector \_\_\_\_\_ Date \_\_\_\_\_

DDOE(WHITE)

OWNER/AGENT(YELLOW)

INSPECTOR (PINK)

Infiltration Facility construction inspection 03/2011



**GOVERNMENT OF THE DISTRICT OF COLUMBIA**  
**DISTRICT DEPARTMENT OF THE ENVIRONMENT**  
**WATERSHED PROTECTION DIVISION**  
**INSPECTION AND ENFORCEMENT BRANCH**  
**Open Channels - Construction Inspection Report**

Building Permit # \_\_\_\_\_ Plan and File # \_\_\_\_\_ Lot: \_\_\_\_\_ Square: \_\_\_\_\_

Project Name and Address: \_\_\_\_\_ Ward: \_\_\_\_\_

Contractor: \_\_\_\_\_ Telephone # \_\_\_\_\_

Engineer: \_\_\_\_\_ Telephone # \_\_\_\_\_

Responsible For Maintenance: \_\_\_\_\_ Telephone # \_\_\_\_\_

Type of Open Channel System : Grass Channel \_\_\_\_\_ Dry Swale \_\_\_\_\_ Wet Swale \_\_\_\_\_ Other \_\_\_\_\_

Date Started: \_\_\_\_\_ Final Inspection Date: \_\_\_\_\_ As-Built Plan Due Date: \_\_\_\_\_

Inspection Items	Yes	No	Remarks	Date Completed
<b>Site Preparation:</b>				
Have erosion and sediment controls been properly installed and maintained according to approved plans?				
Is stormwater runoff being diverted around the facility?				
Has the contributing drainage area been fully stabilized?				

Appendix L Construction Inspection Checklists

Inspection Items	Yes	No	Remarks	Date Completed
<b>Practice Geometry:</b> Are the practice dimensions and longitudinal slope correct as shown on the plans?				
Are the channel side slopes no steeper than 3:1?				
Have the check dams been properly installed and to the correct elevations (where applicable)?				
<b>Pretreatment:</b>  Are the pretreatment facilities installed according to the approved plans?				
<b>Vegetation:</b>  Does the channel surface vegetation comply with the approved planting plan and specification?				
Topsoil mixture, soil amendments, and soil compaction comply with plan (if required)				
<b>Over Flow (where Applicable):</b>  Is overflow invert at correct elevation?				
Has the outfall been constructed with adequate protection as specified on the plans?				
<b>Dry Swale Designs (where Applicable):</b>  Does planting soil meet design specifications?				
Does the underdrain meet specifications with correct hole pattern, elevation, and slope?				
Are at least 2 inches of aggregate provided above and below the underdrains?				
Does the reservoir storage layer drains within 72 hours?				

Owner/Agent \_\_\_\_\_ Inspector \_\_\_\_\_ Date \_\_\_\_\_

DDOE(WHITE)

OWNER/AGENT(YELLOW)

INSPECTOR (PINK)

Open Channel construction inspection 03/2011



This Page Intentionally Left Blank



**GOVERNMENT OF THE DISTRICT OF COLUMBIA**  
**DISTRICT DEPARTMENT OF THE ENVIRONMENT**  
**WATERSHED PROTECTION DIVISION**  
**INSPECTION AND ENFORCEMENT BRANCH**

**Pond, Wetland, And Storage Practices - Construction Inspection Report**

Building Permit # \_\_\_\_\_ Plan and File # \_\_\_\_\_ Lot: \_\_\_\_\_ Square: \_\_\_\_\_

Project Name and Address: \_\_\_\_\_ Ward: \_\_\_\_\_

Contractor: \_\_\_\_\_ Telephone # \_\_\_\_\_

Engineer: \_\_\_\_\_ Telephone # \_\_\_\_\_

Responsible For Maintenance: \_\_\_\_\_ Telephone # \_\_\_\_\_

Type of Facility: Wet Pond \_\_\_\_\_ Wetland \_\_\_\_\_ Dry Pond \_\_\_\_\_ Underground Detention \_\_\_\_\_ Other \_\_\_\_\_

Date Started: \_\_\_\_\_ Final Inspection Date: \_\_\_\_\_ As-Built Plan Due Date: \_\_\_\_\_

Inspection Items	Yes	No	Remarks	Date Completed
<b>Contributing Drainage Area:</b> Does the area draining to the practice match the plans?				
<b>Practice Geometry:</b> Are the practice dimensions correct as shown on the plans?				
Are the pond side slopes no steeper than 3:1?				

Appendix L Construction Inspection Checklists

---

Inspection Items	Yes	No	Remarks	Date Completed
Is a geotextile or clay lining provided (where appropriate)?				
Is the practice installed to the proper depth as shown on the plans?				
<p><b>Pretreatment:</b></p> <p>Has the forebay been properly sized and designed as according to the plans?</p>				
<p><b>Outfall:</b></p> <p>Has the outfall been constructed with adequate protection as specified on the plans?</p>				
Is the outfall channel lined with filter cloth and is large rip-rap provided?				
Is an emergency spillway provided?				



**GOVERNMENT OF THE DISTRICT OF COLUMBIA**  
**DISTRICT DEPARTMENT OF THE ENVIRONMENT**  
**WATERSHED PROTECTION DIVISION**  
**INSPECTION AND ENFORCEMENT BRANCH**

**Pond, Wetland, and Storage Practices Construction Inspection Report--Continued**

Project Name and Address: \_\_\_\_\_ File and WPD No \_\_\_\_\_

Inspection Item	No	Yes	Remarks	Date
<b>Overflow and Trash Rack:</b>				
Has the riser or outflow structure been properly installed and to the correct elevations?				
Has a trash rack been properly installed according to the approved SWM plan?				
<b>Pond Buffer/Vegetation (where applicable):</b>				
Do the buffer dimensions match the plans?				
Is an aquatic bench properly installed?				
Does the vegetation comply with the approved planting plan and specification?				
<b>Final Inspection:</b>				
Has the contributing drainage area been properly stabilized?				
Does the site have proper maintenance and inspection access?				

Owner/Agent \_\_\_\_\_ Inspector \_\_\_\_\_ Date \_\_\_\_\_

DDOE(WHITE)

OWNER/AGENT(YELLOW)

INSPECTOR (PINK)

Pond, Wetland, and Storage Practice construction inspection 03/2011



**GOVERNMENT OF THE DISTRICT OF COLUMBIA**  
**DISTRICT DEPARTMENT OF THE ENVIRONMENT**  
**WATERSHED PROTECTION DIVISION**  
**INSPECTION AND ENFORCEMENT BRANCH**  
**Tree Planting And Preservation - Construction Inspection Report**

Building Permit # \_\_\_\_\_ Plan and File # \_\_\_\_\_ Lot: \_\_\_\_\_ Square: \_\_\_\_\_

Project Name and Address: \_\_\_\_\_ Ward: \_\_\_\_\_

Contractor: \_\_\_\_\_ Telephone # \_\_\_\_\_

Engineer: \_\_\_\_\_ Telephone # \_\_\_\_\_

Responsible For Maintenance: \_\_\_\_\_ Telephone # \_\_\_\_\_

Date Started: \_\_\_\_\_ Final Inspection Date: \_\_\_\_\_ As-Built Plan Due Date: \_\_\_\_\_

Inspection Item	No	Yes	Remarks	Date
<b>Inventory of Trees:</b>				
Did a licensed forester or arborist inventory existing trees?				
Were the size, species, condition, ecological value, and location of the trees recorded?				
<b>Identification of Trees to Preserve:</b>				

Appendix L Construction Inspection Checklists

---

<p>Average mature spread of at least 35'?</p> <p>Were the trees selected to be conserved selected based on species, size, condition, and location?</p>				
<p><b>Protection of Trees and Soil During Construction:</b></p> <p>Did a licensed forester or arborist identify the Critical Root Zone (CRZ) around the trees?</p> <p>Were physical barriers properly installed and maintained around the CRZ?</p> <p>If excavating next to CRZ, were roots properly pruned to depth of 18"?</p>				
<p><b>Protection of Trees and Soil After Construction:</b></p> <p>Is there a Maintenance Covenant in place to protect the preserved trees?</p>				



**GOVERNMENT OF THE DISTRICT OF COLUMBIA**  
**DISTRICT DEPARTMENT OF THE ENVIRONMENT**  
**WATERSHED PROTECTION DIVISION**  
**INSPECTION AND ENFORCEMENT BRANCH**

**Tree Planting and Preservation Construction Inspection Report--Continued**

Project Name and Address: \_\_\_\_\_ File and WPD No \_\_\_\_\_

Inspection Item	No	Yes	Remarks	Date
<p><b>Selection of Tree Species:</b></p> <p>Does the tree species have an average mature spread of at least 35'?</p> <p>Are the trees container grown or ball and burlap?</p> <p>Do the trees have a minimum caliper size of 1.5"?</p>				
<p><b>Planting Sites:</b></p> <p>Was the appropriate tree planted in the best location based on urban planting constraints?</p> <p>Are clear sight lines provided along street and in parking lots?</p> <p>Is there enough overhead clearance for pedestrians and vehicles?</p> <p>Is there at least 2 cubic feet of useable soil per square foot of average mature tree canopy?</p>				

Appendix L Construction Inspection Checklists

Inspection Item	No	Yes	Remarks	Date
<p><b>Planting Techniques:</b></p> <p>Is the root collar exposed?</p> <p>Are erosion control blankets or other appropriate practices in place on steep slopes?</p> <p>With slopes steeper than 3:1, are trees planted on a level space on the slope?</p>				
<p><b>Post-Planting Tree Protection:</b></p> <p>Has 2–4 inches of organic mulch been spread over the soil surface out to the drip line of the tree?</p> <p>Are trees staked only if there is a concern of vandalism or windy exposure?</p>				

Owner/Agent \_\_\_\_\_ Inspector \_\_\_\_\_ Date \_\_\_\_\_

DDOE(WHITE)

OWNER/AGENT(YELLOW)

INSPECTOR (PINK)

Tree Planting and Preservation construction inspection 01/2013





**GOVERNMENT OF THE DISTRICT OF COLUMBIA**  
**DISTRICT DEPARTMENT OF THE ENVIRONMENT**  
**WATERSHED PROTECTION DIVISION**  
**INSPECTION AND ENFORCEMENT BRANCH**

**Stormwater Management Facilities - Construction Inspection Report**

Building Permit # \_\_\_\_\_ Plan and File # \_\_\_\_\_ Lot: \_\_\_\_\_ Square: \_\_\_\_\_

Project Name and Address: \_\_\_\_\_ Ward: \_\_\_\_\_

Contractor: \_\_\_\_\_ Telephone # \_\_\_\_\_

Engineer: \_\_\_\_\_ Telephone # \_\_\_\_\_

Responsible For Maintenance: \_\_\_\_\_ Telephone # \_\_\_\_\_

Date Started: \_\_\_\_\_ Final Inspection Date: \_\_\_\_\_ As-Built Plan Due Date: \_\_\_\_\_

Inspection Items	Yes	No	Remarks	Date
<b>Site Preparation:</b>				
Have erosion and sediment controls been properly installed and maintained according to approved plans?				
Is stormwater runoff being diverted around the facility?				
Has the contributing drainage area been fully stabilized?				

Appendix L Construction Inspection Checklists

---

<p><b>Structure:</b> Do type and location of openings meet plan specifications?</p> <p>Are all components installed as per plan specifications? (media cartridges, weirs, inverted pipes, tees and ports)</p>				
<p><b>Access:</b> Access for each chamber, including inlets where applicable provided? (manholes, doors, steps, ladders)</p>				
<p><b>Backfill :</b> Does back fill meet specifications?</p> <p>Is a certification for lift, thickness and density test provided?</p>				
<p><b>System Cleaned:</b></p>				

Owner/Agent \_\_\_\_\_ Inspector \_\_\_\_\_ Date \_\_\_\_\_

DDOE(WHITE)                      OWNER/AGENT(YELLOW)                      INSPECTOR (PINK)

This Page Intentionally Left Blank



**GOVERNMENT OF THE DISTRICT OF COLUMBIA  
DISTRICT DEPARTMENT OF THE ENVIRONMENT  
NATURAL RESOURCES ADMINISTRATION  
WATERSHED PROTECTION DIVISION/INSPECTION AND ENFORCEMENT  
BRANCH**

**STORMWATER MANAGEMENT STANDARD TESTING RECORD**

PLAN # \_\_\_\_\_ WPD/ FILE # \_\_\_\_\_ BUILDING PERMIT # \_\_\_\_\_

SQUARE \_\_\_\_\_ LOT \_\_\_\_\_ PARCEL \_\_\_\_\_

NAME AND LOCATION: \_\_\_\_\_

TYPE OF STRUCTURE: \_\_\_\_\_

BUILT:  Cast-in place  Pre-Cast  Other \_\_\_\_\_

METHOD OF TESTING:  H<sub>2</sub>O  Visual  Other \_\_\_\_\_

READINGS: Start \_\_\_\_\_

Difference \_\_\_\_\_

Allowable \_\_\_\_\_

Results \_\_\_\_\_

DURATION: (24 Hour Reading) \_\_\_\_\_ Time: \_\_\_\_\_ Date: \_\_\_\_\_

(48 Hour Reading) \_\_\_\_\_ Time: \_\_\_\_\_ Date: \_\_\_\_\_

(72 Hour Reading) \_\_\_\_\_ Time: \_\_\_\_\_ Date: \_\_\_\_\_

READINGS TAKEN BY: \_\_\_\_\_ DATE: \_\_\_\_\_

WITNESS: \_\_\_\_\_ DATE: \_\_\_\_\_

TITLE: \_\_\_\_\_

FOR: \_\_\_\_\_

Inspector \_\_\_\_\_ Owner/Agent \_\_\_\_\_ Date \_\_\_\_\_

DDOE (WHITE)

OWNER/AGENT (YELLOW)

INSPECTOR (PINK)

SWM STANDARD TESTING/ WPD 7/2007

This Page Intentionally Left Blank



# Appendix M Maintenance Inspection Checklists

It is recommended that an annual maintenance inspection and cleanup be conducted at each BMP site, particularly at large-scale applications.

This appendix includes the following maintenance inspection checklists:

<b>Practice Type</b>	<b>Page</b>
Green Roof Maintenance Inspection	M-2
Rainwater Harvesting Maintenance Inspection	M-4
Impervious Cover Disconnection Maintenance Inspection	M-6
Permeable Pavement Maintenance Inspection	M-6
Bioretention Maintenance Inspection	M-7
Filtering System Maintenance Inspection	M-8
Infiltration Facility Maintenance Inspection	M-9
Open Channel Maintenance Inspection	M-10
Wet Ponds and Wetlands Maintenance Inspection	M-11
Storage and Underground Detention Facilities Maintenance Inspection	M-12
Tree Planting and Preservation Maintenance Inspection	M-13
Generic Stormwater Management Facility Maintenance Inspection	M-14
Maintenance Service Completion Inspection	M-16

**GOVERNMENT OF THE DISTRICT OF COLUMBIA**  
**DISTRICT DEPARTMENT OF THE ENVIRONMENT**  
**WATERSHED PROTECTION DIVISION**  
**INSPECTION AND ENFORCEMENT BRANCH**

**Green Roof Maintenance Inspection**

Name / Address: \_\_\_\_\_ WPD No \_\_\_\_\_

Mailing Address: \_\_\_\_\_ Ward: \_\_\_\_\_

Owner / Agent: \_\_\_\_\_ Telephone : \_\_\_\_\_ Lot: \_\_\_\_\_ Square: \_\_\_\_\_

As-Built Plan Available Y/N Last Inspection Date: \_\_\_\_\_ Last Service Date: \_\_\_\_\_ Service Contract Y/N, Type: \_\_\_\_\_

Accessibility: Public \_\_ Private \_\_ Maintenance Personal Only \_\_ (Number of Stories) \_\_ Roof type: Flat \_\_ Sloped \_\_

List all other Stormwater Management Facilities on Site: \_\_\_\_\_

Note: Insert section to record review of on-site maintenance logs

1. Roof Condition:

Overflow Drains, Drain boxes Eves and Scuppers Condition \_\_\_\_\_ Total Number \_\_\_\_\_

Membrane Condition \_\_\_\_\_ Flashing and Caulked Areas Condition \_\_\_\_\_ Roof Repair Needed \_\_\_\_\_

Debris/Sediment Accumulation \_\_ Evidence of Root Penetration \_\_ Peeling or Physical Damage \_\_ Standing Water or Seepage \_\_



## Appendix M Maintenance Inspection Checklists

---

Observations \_\_\_\_\_  
\_\_\_\_\_

Note: Insert measure of plant coverage

### 2. Vegetated Areas:

Roof Type: Intensive \_ Extensive \_ Semi-intensive \_ Vegetative System: Plant in place \_\_ Modular Tray System \_ Vegetated Mat \_

Dead or diseased plants \_\_ Weeds, Moss, Invasive Plants or Pest \_\_ Thatch accumulation \_\_ Erosion or loss of media \_ Other \_

Note: Consider clarifying this relative to the green roof design; sometimes the presence of moss is appropriate

Approximate Number of Growing Seasons \_\_\_\_\_ Date of last Fertilizer, Pesticide or Top Dressing Application: \_\_

Observations \_\_\_\_\_  
\_\_\_\_\_

Note Insert section to record observations of growing media that includes measure of media depth

### 3. Watering, Irrigation and Leak Detection:

Method of Watering : Soaker or Drip Hose \_\_\_\_\_ Sprinkler \_\_\_\_\_ Misting System \_\_\_\_\_

Hose Condition \_\_\_\_\_ Mechanical Systems Components (timers, valves, sensors and filters) \_\_\_\_\_ Last Service Date \_\_\_\_\_

Leak Detection Provided Y/N Last Service Date \_\_\_\_\_

Observations \_\_\_\_\_  
\_\_\_\_\_

Inspector \_\_\_\_\_ Received By \_\_\_\_\_ Date \_\_\_\_\_

DDOE(WHITE)

OWNER/AGENT(YELLOW)

INSPECTOR (PINK)

Green Roof maintenance inspection 03/2011



**GOVERNMENT OF THE DISTRICT OF COLUMBIA**  
**DISTRICT DEPARTMENT OF THE ENVIRONMENT**  
**WATERSHED PROTECTION DIVISION**  
**INSPECTION AND ENFORCEMENT BRANCH**  
**Rainwater Harvesting Maintenance Inspection**

Name / Address: \_\_\_\_\_ WPD No \_\_\_\_\_

Mailing Address: \_\_\_\_\_ Ward: \_\_\_\_\_

Owner / Agent : \_\_\_\_\_ Telephone : \_\_\_\_\_ Lot: \_\_\_\_\_ Square: \_

As-Built Plan Available Y/N Last Inspection Date: \_\_\_\_\_ Last Service Date: \_\_\_\_\_ Service Contract Y/N, Type: \_\_\_\_\_

List all other Stormwater Management Facilities on Site: \_\_\_\_\_

1. Tank and System Condition:

Tank Condition \_\_\_\_\_ Gutter and Pipe Condition \_\_\_\_\_ Pump and Electrical System Functioning Properly \_\_\_\_\_

Replacement Parts Needed \_\_\_\_\_ (specify components): \_\_\_\_\_

Observations \_\_\_\_\_

\_\_\_\_\_

Appendix M Maintenance Inspection Checklists

---

2. Inflow and Storage:

Debris in Gutters/ Downspouts \_\_\_\_ Debris in Pre-screening Devices \_\_\_\_ Debris in First Flush Diverters \_\_\_\_

Mosquito Screens Inadequate \_\_ Sediment Accumulation in Tank \_\_ Inadequate Tank Drawdown \_\_ Inconsistent Reuse \_\_

Observations \_\_\_\_\_  
\_\_\_\_\_

3. Overflow:

Over flow Device Y/N, Type: \_\_\_\_\_ Outlet Erosion \_\_\_\_ Debris/ Sediment in Overflow \_\_\_\_ Repair Needed \_\_\_\_

Observations \_\_\_\_\_  
\_\_\_\_\_

Inspector \_\_\_\_\_ Received By \_\_\_\_\_ Date \_\_\_\_\_

DDOE(WHITE)

OWNER/AGENT(YELLOW)

INSPECTOR (PINK)



**GOVERNMENT OF THE DISTRICT OF COLUMBIA**  
**DISTRICT DEPARTMENT OF THE ENVIRONMENT**  
**WATERSHED PROTECTION DIVISION**  
**INSPECTION AND ENFORCEMENT BRANCH**  
**Impervious Cover Disconnection Maintenance Inspection**

Name / Address: \_\_\_\_\_ WPD No \_\_\_\_\_

Mailing Address: \_\_\_\_\_ Ward: \_\_\_\_\_

Owner / Agent : \_\_\_\_\_ Telephone : \_\_\_\_\_ Lot: \_\_\_\_\_ Square: \_\_\_\_\_

Last Inspection Date: \_\_\_\_\_ Last Service Date: \_\_\_\_\_ Service Contract Y/N, Type: \_\_\_\_\_

Type of Disconnection: Simple \_\_\_\_\_ Dry Well \_\_\_\_\_ Rain Garden \_\_\_\_\_  
Other \_\_\_\_\_

List all other Stormwater Management Facilities on Site: \_\_\_\_\_

1. Contributing Drainage Area:

Type of Drainage Area: Rooftop \_\_\_\_\_ Parking Lot \_\_\_\_\_ Other \_\_\_\_\_

Observations \_\_\_\_\_

\_\_\_\_\_

Appendix M Maintenance Inspection Checklists

---

2. Receiving Area:

Improper Conveyance to Receiving Pervious Area \_\_\_\_\_ Receiving Area Encroachment \_\_\_\_\_ Compaction Receiving Area \_\_\_\_\_

Erosion at Inflow Points \_\_\_\_\_ Erosion in Flow Path \_\_\_\_\_ Dead Vegetation \_\_\_\_\_ Exposed Soil \_\_\_\_\_ Sediment Accumulation \_\_\_\_\_

Evidence of Standing Water \_\_\_\_\_

Observations \_\_\_\_\_

\_\_\_\_\_

Inspector \_\_\_\_\_ Received By \_\_\_\_\_ Date \_\_\_\_\_

DDOE(WHITE)

OWNER/AGENT(YELLOW)

INSPECTOR (PINK)

Impervious Cover Disconnection maintenance inspection 03/2011



**GOVERNMENT OF THE DISTRICT OF COLUMBIA**  
**DISTRICT DEPARTMENT OF THE ENVIRONMENT**  
**WATERSHED PROTECTION DIVISION**  
**INSPECTION AND ENFORCEMENT BRANCH**  
**Permeable Pavement Maintenance Inspection**

Name / Address: \_\_\_\_\_ WPD No \_\_\_\_\_

Mailing Address: \_\_\_\_\_ Ward: \_\_\_\_\_

Owner / Agent : \_\_\_\_\_ Telephone : \_\_\_\_\_ Lot: \_\_\_\_\_ Square: \_\_\_\_\_

As-Built Plan Available Y/N Last Inspection Date: \_\_\_\_\_ Last Service Date: \_\_\_\_\_ Service Contract Y/N, Type: \_\_\_\_\_

List all other Stormwater Management Facilities on Site: \_\_\_\_\_

1. Surface Condition:

Debris/ Sediment Accumulation \_\_\_ Weed Accumulation \_\_\_\_\_ Evidence of Surface Clogging \_\_\_ Sweeping Needed \_\_\_\_\_

Surface Deformation or Spalling \_\_\_\_\_ Structural Repair Needed \_\_\_\_\_

Observations \_\_\_\_\_

\_\_\_\_\_

Appendix M Maintenance Inspection Checklists

---

2. Underdrains and Cleanouts:

Underdrains Y/N, Number: \_\_\_\_\_ Observation Wells Y/N, Number: \_\_\_\_\_

Evidence of Subsurface Clogging\_\_ Inadequate Drawdown\_\_\_\_\_ Standing Water \_\_\_\_\_ Last Rain Event >1” +/- \_\_ Days/Hours

Observations \_\_\_\_\_  
\_\_\_\_\_

3. Overflow:

Over flow Device Y/N, Type: \_\_\_\_\_ Debris/ Sediment in Overflow\_\_\_\_\_ Repair Needed \_\_\_\_\_

Observations \_\_\_\_\_  
\_\_\_\_\_

Inspector \_\_\_\_\_ Received By \_\_\_\_\_ Date \_\_\_\_\_

DDOE(WHITE)

OWNER/AGENT(YELLOW)

INSPECTOR (PINK)



**GOVERNMENT OF THE DISTRICT OF COLUMBIA**  
**DISTRICT DEPARTMENT OF THE ENVIRONMENT**  
**WATERSHED PROTECTION DIVISION**  
**INSPECTION AND ENFORCEMENT BRANCH**  
**Bioretention Facility Maintenance Inspection**

Name / Address: \_\_\_\_\_ WPD No \_\_\_\_\_

Mailing Address: \_\_\_\_\_ Ward: \_\_\_\_\_

Owner / Agent : \_\_\_\_\_ Telephone : \_\_\_\_\_ Lot: \_\_\_\_\_ Square: \_\_\_\_\_

As-Built Plan Available Y/N Last Inspection Date: \_\_\_\_\_ Last Service Date: \_\_\_\_\_ Service Contract Y/N, Type: \_\_\_\_\_

List all other Stormwater Management Facilities on Site: \_\_\_\_\_

1. Inlets and Drainage Area Stabilization:

Inlet Type (s) \_\_\_\_\_ Total Number \_\_\_\_\_ Repair Needed \_\_\_\_\_ Debris/ Sediment Accumulation \_\_\_\_\_

Evidence of Erosion in Drainage Area \_\_\_\_\_ Area Needs Mowing or Clipping Removal \_\_\_\_\_ Drainage Area Debris Accumulation \_\_\_\_\_

Observations \_\_\_\_\_

\_\_\_\_\_



Appendix M Maintenance Inspection Checklists

---

2. Bioretention Facility:

Sediments/Trash Accumulation \_\_\_ Filter Surface Clogging \_\_\_ Erosion in Facility \_\_\_ Inadequate Mulch Thickness or Cover \_\_\_

Outlet: Condition of Outlet \_\_\_ Debris/ Sediment in Overflow \_\_\_ Repair Needed \_\_\_

Underdrains and Cleanouts: Underdrains Y/N, Number: \_\_\_\_\_ Observation Wells Y/N, Number: \_\_\_\_\_

Evidence of subsurface clogging \_\_\_ Inadequate drawdown \_\_\_ Standing Water \_\_\_ Last Rain Event >1" +/- \_\_\_ Days/Hours

Observations \_\_\_\_\_  
\_\_\_\_\_

3. Plants:

Specific Number and Types of Plants in Place \_\_\_ Dead or Diseased plants \_\_\_ Stakes and Wires \_\_\_ Inadequate Watering \_\_\_

Observations \_\_\_\_\_  
\_\_\_\_\_

Note: A qualified professional must treat disease plants. Deficient stakes or wires must be replaced. Dead plants or plants beyond treatment must be replaced by plants meeting original specifications. New plants must be watered every day for the first 14 days after planting.

Inspector \_\_\_\_\_ Received By \_\_\_\_\_ Date \_\_\_\_\_

DDOE(WHITE)

OWNER/AGENT(YELLOW)

INSPECTOR (PINK)

Bioretention maintenance inspection 3/2010



**GOVERNMENT OF THE DISTRICT OF COLUMBIA**  
**DISTRICT DEPARTMENT OF THE ENVIRONMENT**  
**WATERSHED PROTECTION DIVISION**  
**INSPECTION AND ENFORCEMENT BRANCH**  
**Filtering System Maintenance Inspection**

Name / Address: \_\_\_\_\_ WPD No \_\_\_\_\_

Mailing Address: \_\_\_\_\_ Ward: \_\_\_\_\_

Owner / Agent : \_\_\_\_\_ Telephone : \_\_\_\_\_ Lot: \_\_\_\_\_ Square: \_

As-Built Plan Available Y/N Last Inspection Date: \_\_\_\_\_ Last Service Date: \_\_\_\_\_ Service Contract Y/N, Type: \_\_\_\_\_

List all other Stormwater Management Facilities on Site: \_\_\_\_\_

1. Structural Components and Filter Bed:

Pretreatment Y/N, Type: \_\_\_\_\_ Condition: \_\_\_\_\_ Chambers Y/N, Number: \_\_\_\_ Condition: \_\_\_\_\_

Filter Bed Condition: \_\_\_\_\_ Oil/Grease Accumulation \_\_\_\_ Debris Accumulation \_\_\_\_ Evidence of Bypass \_\_\_\_

Observation Wells Y/N, Condition: \_\_\_\_\_ Maintenance Doors Y/N, Condition: \_\_\_\_\_ Manholes Y/N, Condition: \_\_\_\_

Valves/Drains Y/N, Condition: \_\_\_\_\_ Water Seal Y/N, Condition: \_\_\_\_\_ Other \_\_\_\_\_

Inadequate drawdown \_\_\_\_ Standing Water \_\_\_\_ Last Rain Event > 1" +/- \_\_\_\_\_ Hours/ Days

Observations

---

---

Appendix M Maintenance Inspection Checklists

---

2. Inlets:

Type \_\_\_\_\_ Total Number \_\_\_\_\_ Repair Needed \_\_\_\_\_ Debris/Sediment Accumulation \_\_\_\_\_

Observations \_\_\_\_\_

\_\_\_\_\_

3. Outlets

Over flow Device Y/N, Type: \_\_\_\_\_ Debris/ Sediment in Overflow \_\_\_\_\_ Repair Needed \_\_\_\_\_

Observations \_\_\_\_\_

\_\_\_\_\_

Inspector \_\_\_\_\_ Received By \_\_\_\_\_ Date \_\_\_\_\_

DDOE(WHITE)

OWNER/AGENT(YELLOW)

INSPECTOR (PINK)

Sand Filter maintenance inspection 3/2010



**GOVERNMENT OF THE DISTRICT OF COLUMBIA**  
**DISTRICT DEPARTMENT OF THE ENVIRONMENT**  
**WATERSHED PROTECTION DIVISION**  
**INSPECTION AND ENFORCEMENT BRANCH**  
**Infiltration Facility Maintenance Inspection**

Name / Address: \_\_\_\_\_ WPD No \_\_\_\_\_

Mailing Address: \_\_\_\_\_ Ward: \_\_\_\_\_

Owner / Agent : \_\_\_\_\_ Telephone : \_\_\_\_\_ Lot: \_\_\_\_\_ Square: \_

As-Built Plan Available Y/N Last Inspection Date: \_\_\_\_\_ Last Service Date: \_\_\_\_\_ Service Contract Y/N, Type: \_\_\_\_

Infiltration Device Type: Dry Well \_\_\_\_\_ Infiltration  
Trench \_\_\_\_\_ Other \_\_\_\_\_

List all other Stormwater Management Facilities on Site: \_\_\_\_\_

1. Inlets and Drainage Area Stabilization:

Inlet Type (s) \_\_\_\_\_ Total Number \_\_\_\_\_ Repair Needed \_\_\_\_\_ Debris/ Sediment Accumulation \_\_\_\_\_

Erosion in Drainage Area\_ Area Needs Mowing/Clipping Removal\_ Drainage Area Debris Accumulation \_Pretreatment Bypass

Observations \_\_\_\_\_  
\_\_\_\_\_

2. Structural Components and Function:

Vegetation and Ground Cover Type: \_\_\_\_\_ Surface Erosion Present? Y/N

Appendix M Maintenance Inspection Checklists

---

Condition of Infiltration Area \_\_\_\_\_ Observation Wells Y/N, Number: \_\_\_\_\_ Condition:  
\_\_\_\_\_

Inadequate Drawdown \_\_\_\_\_ Standing Water \_\_\_\_\_ Debris/Sediment Accumulation \_\_\_\_\_ Last Rain Event >1" +/- \_\_\_\_\_  
Days/Hours

Observations \_\_\_\_\_  
\_\_\_\_\_

3. Overflow:

Over flow Device Y/N, Type: \_\_\_\_\_ Debris/ Sediment in Overflow \_\_\_\_\_ Repair Needed \_\_\_\_\_

Observations \_\_\_\_\_  
\_\_\_\_\_

Inspector \_\_\_\_\_ Received By \_\_\_\_\_ Date \_\_\_\_\_

DDOE(WHITE)

OWNER/AGENT(YELLOW)

INSPECTOR (PINK)

Infiltration Facility maintenance inspection 03/2011



**GOVERNMENT OF THE DISTRICT OF COLUMBIA**  
**DISTRICT DEPARTMENT OF THE ENVIRONMENT**  
**WATERSHED PROTECTION DIVISION**  
**INSPECTION AND ENFORCEMENT BRANCH**  
**Open Channels Maintenance Inspection**

Name / Address: \_\_\_\_\_ WPD No \_\_\_\_\_

Mailing Address: \_\_\_\_\_ Ward: \_\_\_\_\_

Owner / Agent : \_\_\_\_\_ Telephone : \_\_\_\_\_ Lot: \_\_\_\_\_ Square: \_\_\_\_\_

As-Built Plan Available Y/N Last Inspection Date: \_\_\_\_\_ Last Service Date: \_\_\_\_\_ Service Contract Y/N, Type: \_\_\_\_\_

Type of Open Channel System : Grass Channel \_\_\_\_\_ Dry Swale \_\_\_\_\_ Wet Swale \_\_\_\_\_ Other \_\_\_\_\_

List all other Stormwater Management Facilities on Site: \_\_\_\_\_

1. Inlets and Drainage Area Stability:

Type \_\_\_\_\_ Total Number \_\_\_\_\_ Repair Needed \_\_\_\_\_ Clear of Debris/Sediment \_\_\_\_\_

Erosion at Inlets \_\_\_\_\_ Evidence of Pretreatment Bypass \_\_\_\_\_ Evidence of Erosion in drainage area \_\_\_\_\_

Observations \_\_\_\_\_

\_\_\_\_\_

Appendix M Maintenance Inspection Checklists

---

2. Open Channel Facility:

Debris/ Sediment Accumulation \_\_\_ Erosion within Facility \_\_\_ Inappropriate Ponding of Water \_\_\_ Erosion at Outlets \_\_\_

Condition of Check Dams (if applicable) \_\_\_ Condition of Underdrain (if applicable) \_\_\_ Condition of Outlet \_\_\_

Observations \_\_\_\_\_

\_\_\_\_\_

3. Vegetation:

Dead Vegetation \_\_\_ Bare Spots \_\_\_ Presence of Invasive Species \_\_\_ Re-vegetation Needed \_\_\_

Observations \_\_\_\_\_

\_\_\_\_\_

Inspector \_\_\_\_\_ Received By \_\_\_\_\_ Date \_\_\_\_\_

DDOE(WHITE)

OWNER/AGENT(YELLOW)

INSPECTOR (PINK)

DDOE(WHITE)

OWNER/AGENT(YELLOW)

INSPECTOR (PINK)

Open Channel maintenance inspection 03/2011



**GOVERNMENT OF THE DISTRICT OF COLUMBIA**  
**DISTRICT DEPARTMENT OF THE ENVIRONMENT**  
**WATERSHED PROTECTION DIVISION**  
**INSPECTION AND ENFORCEMENT BRANCH**

**Wet Ponds And Wetlands Maintenance Inspection**

Name / Address: \_\_\_\_\_ WPD No \_\_\_\_\_

Mailing Address: \_\_\_\_\_ Ward: \_\_\_\_\_

Owner / Agent : \_\_\_\_\_ Telephone : \_\_\_\_\_ Lot: \_\_\_\_\_ Square: \_\_\_\_\_

As-Built Plan Available Y/N Last Inspection Date: \_\_\_\_\_ Last Service Date: \_\_\_\_\_ Service Contract Y/N, Type: \_\_\_\_\_

Type of Facility: Wet Pond \_\_\_\_\_ Wetland \_\_\_\_\_ Other \_\_\_\_\_

List all other Stormwater Management Facilities on Site: \_\_\_\_\_

1. Inlets and Drainage Area Stabilization:

Inlet Type (s) \_\_\_\_\_ Total Number \_\_\_\_\_ Repair Needed \_\_\_\_\_ Debris/ Sediment Accumulation \_\_\_\_\_

Erosion in Drainage Area \_\_\_\_\_ Drainage Area Debris Accumulation \_\_\_\_\_ Pretreatment Bypass \_\_\_\_\_

Observations \_\_\_\_\_

\_\_\_\_\_



Appendix M Maintenance Inspection Checklists

---

2. Facility Function and Structural Components:

Erosion within Facility \_\_\_\_\_ Debris/Sediment Accumulation \_\_\_\_\_ Inadequate Water Level \_\_\_\_\_ Excessive Algal Growth \_\_\_\_\_

Over flow Device Y/N, Type: \_\_\_\_\_ Debris/ Sediment in Overflow \_\_\_\_\_ Repair Needed \_\_\_\_\_

Observations \_\_\_\_\_

\_\_\_\_\_

3. Vegetation:

Dead or Diseased plants \_\_\_\_\_ Inadequate Vegetation \_\_\_\_\_ Lack of Aquatic Bench \_\_\_\_\_ Lack of Plant Diversity \_\_\_\_\_

Observations \_\_\_\_\_

\_\_\_\_\_

Inspector \_\_\_\_\_ Received By \_\_\_\_\_ Date \_\_\_\_\_

DDOE(WHITE)

OWNER/AGENT(YELLOW)

INSPECTOR (PINK)

Wet Pond and Wetland maintenance inspection 03/2011



**GOVERNMENT OF THE DISTRICT OF COLUMBIA**  
**DISTRICT DEPARTMENT OF THE ENVIRONMENT**  
**WATERSHED PROTECTION DIVISION**  
**INSPECTION AND ENFORCEMENT BRANCH**

**Storage And Underground Detention Facilities Maintenance Inspection**

Name / Address: \_\_\_\_\_ WPD No \_\_\_\_\_

Mailing Address: \_\_\_\_\_ Ward: \_\_\_\_\_

Owner / Agent : \_\_\_\_\_ Telephone : \_\_\_\_\_ Lot: \_\_\_\_\_ Square: \_\_\_\_\_

As-Built Plan Available Y/N Last Inspection Date: \_\_\_\_\_ Last Service Date: \_\_\_\_\_ Service Contract Y/N, Type: \_\_\_\_\_

Type of Storage Practice: Dry Pond \_\_\_\_\_ Underground Detention \_\_\_\_\_ Other \_\_\_\_\_

List all other Stormwater Management Facilities on Site: \_\_\_\_\_

1. Inlets and Drainage Area Stabilization:

Inlet Type (s) \_\_\_\_\_ Total Number \_\_\_\_\_ Repair Needed \_\_\_\_\_ Debris/ Sediment Accumulation \_\_\_\_\_

Erosion in Drainage Area \_\_\_\_\_ Drainage Area Debris Accumulation \_\_\_\_\_ Pretreatment Bypass \_\_\_\_\_

Observations \_\_\_\_\_

Appendix M Maintenance Inspection Checklists

---

2. Facility Function:

Inadequate Vegetation and/or Ground Cover (if applicable) \_\_\_\_\_ Surface Erosion in Facility \_\_\_\_\_ Debris/Sediment Accumulation \_\_\_\_\_

Inadequate Drawdown \_\_\_\_\_ Standing Water \_\_\_\_\_ Last Rain Event >1" +/- \_\_\_\_\_ Days/Hours

Observations \_\_\_\_\_  
\_\_\_\_\_

3. Structural Components:

Over flow Device Y/N, Type: \_\_\_\_\_ Debris/ Sediment in Overflow \_\_\_\_\_ Repair Needed \_\_\_\_\_

Vaults/Chambers Y/N, Type: \_\_\_\_\_ Debris/ Sediment in Chambers \_\_\_\_\_ Repair Needed \_\_\_\_\_

Observations \_\_\_\_\_  
\_\_\_\_\_

Inspector \_\_\_\_\_ Received By \_\_\_\_\_ Date \_\_\_\_\_

DDOE(WHITE)

OWNER/AGENT(YELLOW)

INSPECTOR (PINK)

Storage Facility maintenance inspection 03/2011



**GOVERNMENT OF THE DISTRICT OF COLUMBIA**  
**DISTRICT DEPARTMENT OF THE ENVIRONMENT**  
**WATERSHED PROTECTION DIVISION**  
**INSPECTION AND ENFORCEMENT BRANCH**  
**Tree Planting And Preservation Maintenance Inspection**

Name / Address: \_\_\_\_\_ WPD No \_\_\_\_\_

Mailing Address: \_\_\_\_\_ Ward: \_\_\_\_\_

Owner / Agent : \_\_\_\_\_ Telephone : \_\_\_\_\_ Lot: \_\_\_\_\_ Square: \_\_\_\_\_

As-Built Plan Available Y/N Last Inspection Date: \_\_\_\_\_ Last Service Date: \_\_\_\_\_ Service Contract Y/N, Type: \_\_\_\_\_

List all other Stormwater Management Facilities on Site: \_\_\_\_\_

1. Tree Condition:

Adequately watered \_\_\_\_\_ Dead/broken/diseased branches pruned \_\_\_\_\_ Trunk protected \_\_\_\_\_ Root collar exposed \_\_\_\_\_

Mower/weed whip damage, vandal damage, animal damage \_\_\_\_\_ Insect or disease problems \_\_\_\_\_

Observations \_\_\_\_\_  
\_\_\_\_\_  
\_\_\_\_\_

Appendix M Maintenance Inspection Checklists

---

2. Mulching:

2"-4" deep mulch \_\_\_\_\_ Mulch not against trunk \_\_\_\_\_

Observations \_\_\_\_\_  
\_\_\_\_\_

3. Staking (if needed):

Tree age < 1 year: Stakes in place \_\_\_\_\_ Webbing or ties hampering growth of tree \_\_\_\_\_

Tree age > 1 year: Stakes removed \_\_\_\_\_

Observations \_\_\_\_\_  
\_\_\_\_\_

Inspector \_\_\_\_\_ Received By \_\_\_\_\_ Date \_\_\_\_\_

DDOE(WHITE)

OWNER/AGENT(YELLOW)

INSPECTOR (PINK)

Tree Planting and Preservation maintenance inspection 01/2013



**GOVERNMENT OF THE DISTRICT OF COLUMBIA  
DISTRICT DEPARTMENT OF THE ENVIRONMENT**

**WATERSHED PROTECTION DIVISION**

**INSPECTION AND ENFORCEMENT BRANCH**

**Stormwater Management Facilities Maintenance Inspection**

Name / Address: \_\_\_\_\_ WPD No. \_\_\_\_\_

Mailing Address: \_\_\_\_\_ Lot \_\_\_\_\_ Sq \_\_\_\_\_

Owner/ Agent: \_\_\_\_\_ Telephone: \_\_\_\_\_ Ward \_\_\_\_\_

Last Inspection Date: \_\_\_\_\_ Last Service Date: \_\_\_\_\_

Type of Facility: \_\_\_\_\_ Other Stormwater Facilities on Site: \_\_\_\_\_

**1. Inlets and Above Ground Condition:**

Type \_\_\_\_\_ Total Number \_\_\_\_\_ Repair \_\_\_\_\_ Clear of debris \_\_\_\_\_ Graded Areas \_\_\_\_\_

Observations

---

---

**2. Structure:**

Access \_\_\_\_\_ Outlets \_\_\_\_\_ Elbows and Connections \_\_\_\_\_ Vaults and Chambers \_\_\_\_\_ Trash Racks \_\_\_\_\_

Observations

---

---

**3. Overall function:**

Oil and Grease Accumulation \_\_\_\_\_ Sediment \_\_\_\_\_ Debris Accumulation \_\_\_\_\_ Last Rain > 1" +/- \_\_\_\_\_ Hours/Days

Observations

---

---

Inspector \_\_\_\_\_ Received By \_\_\_\_\_ Date \_\_\_\_\_

DDOE(WHITE)

OWNER/AGENT(YELLOW)

INSPECTOR (PINK)

Stormwater Management Facility/WPD/7/2007



**GOVERNMENT OF THE DISTRICT OF COLUMBIA  
DISTRICT DEPARTMENT OF THE ENVIRONMENT  
WATERSHED PROTECTION DIVISION**

**INSPECTION AND ENFORCEMENT BRANCH**

**STORMWATER MANAGEMENT STANDARD TESTING RECORD**

PLAN # \_\_\_\_\_ WPD/ FILE # \_\_\_\_\_ BUILDING PERMIT # \_\_\_\_\_

SQUARE \_\_\_\_\_ LOT \_\_\_\_\_ PARCEL \_\_\_\_\_

NAME AND LOCATION: \_\_\_\_\_

TYPE OF STRUCTURE: \_\_\_\_\_

BUILT:  Cast-in place  Pre-Cast  Other \_\_\_\_\_

METHOD OF TESTING:  H<sub>2</sub>O  Visual  Other \_\_\_\_\_

READINGS: Start \_\_\_\_\_

Difference \_\_\_\_\_

Allowable \_\_\_\_\_

Results \_\_\_\_\_

DURATION: (24 Hour Reading) \_\_\_\_\_ Time: \_\_\_\_\_ Date: \_\_\_\_\_

(48 Hour Reading) \_\_\_\_\_ Time: \_\_\_\_\_ Date: \_\_\_\_\_

(72 Hour Reading) \_\_\_\_\_ Time: \_\_\_\_\_ Date: \_\_\_\_\_

READINGS TAKEN BY: \_\_\_\_\_ DATE: \_\_\_\_\_

WITNESS: \_\_\_\_\_ DATE: \_\_\_\_\_

TITLE: \_\_\_\_\_

FOR: \_\_\_\_\_

Inspector \_\_\_\_\_ Owner/Agent \_\_\_\_\_ Date \_\_\_\_\_

DDOE(WHITE)  
Stormwater Management Facility/WPD/7/2007

OWNER/AGENT(YELLOW)

INSPECTOR (PINK)



**GOVERNMENT OF THE DISTRICT OF COLUMBIA  
DISTRICT DEPARTMENT OF THE ENVIRONMENT  
WATERSHED PROTECTION DIVISION  
INSPECTION AND ENFORCEMENT BRANCH**

**MAINTENANCE SERVICE COMPLETION INSPECTION**

Name / Address: \_\_\_\_\_

Owner/Agent: \_\_\_\_\_ WPD No: \_\_\_\_\_

Mailing Address: \_\_\_\_\_

Service Providers: \_\_\_\_\_

Maintenance Service Start Date: \_\_\_\_\_

Maintenance Service Completion Date: \_\_\_\_\_

Type of Stormwater Facility Serviced: \_\_\_\_\_

Description of Work: \_\_\_\_\_

\_\_\_\_\_

Is the maintenance service satisfactory? Yes/No If no, list items to be completed: \_\_\_\_\_

\_\_\_\_\_

\_\_\_\_\_

Inspector \_\_\_\_\_ Received By \_\_\_\_\_ Date \_\_\_\_\_

DDOE(WHITE)

OWNER/AGENT(YELLOW)

INSPECTOR (PINK)



# **Appendix N      Tiered Risk Assessment Management: Water Quality End Use Standards**

## **N.1 Tiered Risk Assessment Management (TRAM): Water Quality End Use Standards for Harvested Stormwater for Non-potable Uses**

This work was commissioned by the District of Columbia Department of the Environment (DDOE) to provide a frame work for applicants to follow when proposing a non-potable use of harvested stormwater runoff to comply with site stormwater retention regulations. Suggested water quality standards are drawn from a literature review of the field and rely largely on international guidance developed in Australia and the United Kingdom, guidance has also been drawn from the State of Texas and from the California County of Los Angeles. The proposed application process presented here requires the assessment of contaminates of concerns based on the collection surface(s), along with an assessment of the public health threat for categories of microbial and chemical contaminants. Under this scheme, an applicant is required to consider the potential risk of exposure and related magnitude of human health impacts with exposure. A tiered risk assessment-management (TRAM) approach is provided to evaluate site conditions and determine treatment level if needed. If treatment is required this guidance provides a procedure for evaluating any remaining public health risk (residual risk) at the time of the commissioning of treatment practices, as well an ongoing procedure to ensure those practices meet public health standards throughout their maintenance and operation.

## **N.2 Health Risks**

Rainwater collection systems have a long history going back as far as 3000 BC in India. It was used widely for agriculture throughout South East Asia over 2,000 years ago and in early Rome rainwater harvesting systems provided central air conditioning. Although rainwater harvesting has a significant and successful history, its popularity has declined as the large urban central water distribution system has grown. The return to rainwater harvesting in current times is driven largely by two factors, water scarcity and pollution of receiving waters. However, as we reconsider the collection of stormwater for non-potable uses, we must also recognize this can pose health risks. Health risks are due to two principal categories of contaminants—pathogenic microorganisms and toxic chemicals. Although both categories of contaminants need to be evaluated to ensure public health will be protected, microorganisms will typically pose the greatest health risk at most sites where stormwater is harvested for non-potable uses. Microbial hazards include bacteria, viruses, protozoa, and—to a lesser extent—helminthes. Chemical hazards can include inorganic and organic chemicals, pesticides, potential endocrine disruptors, pharmaceuticals, and disinfection byproducts. Proposals for stormwater harvested for non-potable uses submitted to DDOE will require an assessment of the public health threat for both categories of contaminants. This assessment starts with an analysis of the likelihood of exposure

and can proceed through risk-based screening to determine if stormwater harvested for non-potable uses will pose a threat to public health.

DDOE cannot anticipate all site conditions within the wide spectrum of projects that may be proposed to harvest stormwater for non-potable uses to comply with District of Columbia stormwater regulations. For this reason, DDOE has developed a tiered risk assessment-management (TRAM) approach that applicants shall follow. Formal risk assessments can be costly, time consuming, and—for many stormwater projects—unnecessary. DDOE developed the TRAM approach to reduce the cost and level of effort associated with preparing the submission of a Stormwater Management Plan (SWMP) that incorporates stormwater harvesting for non-potable uses. The TRAM approach is based on the concept that increasing levels of sophistication, level of effort, and cost of a risk assessment only need to be considered as site conditions warrant. From a risk management perspective, the overarching goal in any project proposing to harvest stormwater for non-potable uses is to demonstrate that public health will be protected when the stormwater project is fully operational.

In addition to providing a cost-effective approach for making risk management decisions, the TRAM approach can be used to identify the most cost-effective risk mitigation strategy (should it be necessary). The two types of health risks planners must consider are maximum risk (posed by untreated stormwater) and residual risk (posed by treated stormwater).

Maximum risk is defined as the risk associated with maximum exposure to untreated stormwater. It is the risk posed by stormwater under the intended non-potable use prior to any preventive measure to disinfect or otherwise decontaminate stormwater. Estimating the maximum risk is necessary for DDOE to issue a permit, and it must be based on the specific exposures that are reasonably anticipated for the untreated stormwater. High-priority contaminants significantly contributing to the maximum risk should be the primary focus if a treatment plan is required. If the maximum risk is acceptable, no treatment of collected stormwater is necessary. However, if the maximum risk exceeds acceptable levels, stormwater must be treated to reduce health risks to acceptable levels.

DDOE will not be prescriptive with regard to the technology selected to protect public health. However, the threshold criterion for approving a SWMP with harvest for non-potable uses system is ensuring public health will be protected.

DDOE will make a determination on the effectiveness of the risk reduction strategy based on the magnitude of the second type of risk—namely, residual risk. Residual risk is defined as the risk remaining after stormwater has been treated based on the specific types of human exposure associated with the intended stormwater reuse.

For permitting purposes, DDOE will require proof that the residual risk from both microbial and chemical contaminants will be reduced to acceptable levels. The magnitude of residual risk is dependent on the magnitude of the maximum risk (the pretreatment risk) and the efficiency of the risk mitigation technology selected for the project.

### **N.3 Evaluating the Threat to Public Health**

The threat to public health is a function of two site-specific criteria—namely, the likelihood of exposure and the magnitude of health risks associated with site-specific exposure conditions. Table N.1 through Table N.3 presents a useful matrix that planners can use to evaluate these two primary criteria during project planning. Proposed plans submitted to DDOE should be based on the classification scheme presented in these tables because it will streamline both the process of planning a stormwater project and DDOE’s review of the submitted plans.

Table N.1 presents three categories for determining the likelihood of exposure. For some stormwater programs, human exposures will only occur under unusual site conditions. For example, in closed systems where contact with collected stormwater is not anticipated (unless there is a breach in the system), the likelihood of exposure would be classified as unlikely. Under these conditions, stormwater use would not pose a health threat and a treatment system would be unnecessary.

Where exposures are classified as possible or likely, a more detailed analysis of potential maximum health risks for the untreated stormwater will be required. An applicant will identify all proposed collection surfaces to determine potential contaminants of concern (COC). If collection surfaces include any existing surfaces, i.e., contributing drainage areas that exist pre-project will remain as part of the final development and will contribute to the proposed rainwater harvest system, sampling of those site conditions may be required to identify COC.

When sampling existing surfaces that are proposed to contribute to the rainwater harvesting system in the proposed development contaminant levels in these samples will be compared with risk-based levels that DDOE has derived for a select group of chemicals. Samples will also be screened for microbial threats. Table N.2 presents three categories of risks that roughly characterize maximum risk. Whether stormwater treatment is necessary will depend on the magnitude of maximum risk, which will be quantified with a risk-based screening approach. When contaminant levels are equal to or less than the risk-based levels, the maximum risk is classified as low or acceptable, and stormwater can be used without any treatment. When contaminant concentrations in stormwater are less than ten-times the risk-based concentration, the maximum risk is characterized as minor and DDOE will use its discretion to decide whether treatment is necessary.

Table N.3 shows the matrix of all possible outcomes for the combined evaluation of the likelihood of exposure and magnitude of health risks. These represent the classification of the health threat. Treatment technologies will not be required for stormwater harvesting projects posing a low threat. DDOE will use professional judgment to determine if moderate threats require a treatment system. Treatment systems will be required for high threats to public health.

Finally, all proposals shall present an analysis of both intended and unintended uses and exposures. While these situations may be rare and unique, they could pose a high risk to a small number of individuals. This could include inadvertent cross connections with drinking water systems and maintenance personnel or children being unintentionally exposed to untreated stormwater. Rainwater harvest proposals must identify how those unintended uses and exposures

will be avoided. Some examples of protective measures include backflow protectors, use of purple pipes and identification stamps, water coloring and signage.

**Table N.1 Likelihood Exposure will Occur**

Descriptor	Description of Likelihood
Unlikely	Exposure could occur only in unusual circumstances
Possible	Exposure might occur
Likely	Exposure will probably occur

**Table N.2 Magnitude of Health Risk**

Descriptor	Risk
Insignificant	Low or Acceptable Levels
Minor	Minor
Severe	Major

**Table N.3 Characterizing Threat to Public Health**

Likelihood of Exposure	Magnitude of Public Health Threat		
	Insignificant	Minor	Severe
Unlikely	Low	Low	Low
Possible	Low	Moderate	High
Likely	Low	Moderate	High

## N.4 Applying the Tiered Risk Assessment-Management Approach

DDOE’s intent in developing the TRAM approach is to expedite the permitting process and keep investigative costs to a minimum. It is based on the concept that the complexity of investigations should match the complexity of the site and conditions of exposure. DDOE will only require that sufficient information be presented to satisfy the requirement that public health is protected. The level of effort necessary to verify this threshold will depend on site-specific characteristics, which will vary from site to site.

The TRAM approach is presented in a risk assessment-management decision-making framework. Although there are a total of nine steps in this process, proposed plans need only present sufficient analyses to demonstrate public health will be protected. For many sites, the entire nine-step process will not be needed to demonstrate exposure to treated or untreated stormwater will pose low risks. A determination regarding the appropriate course of action can often be made in the first four steps. DDOE believes that the most cost-effective approach for project teams is to follow the TRAM, so the complexity, level of effort, and costs of

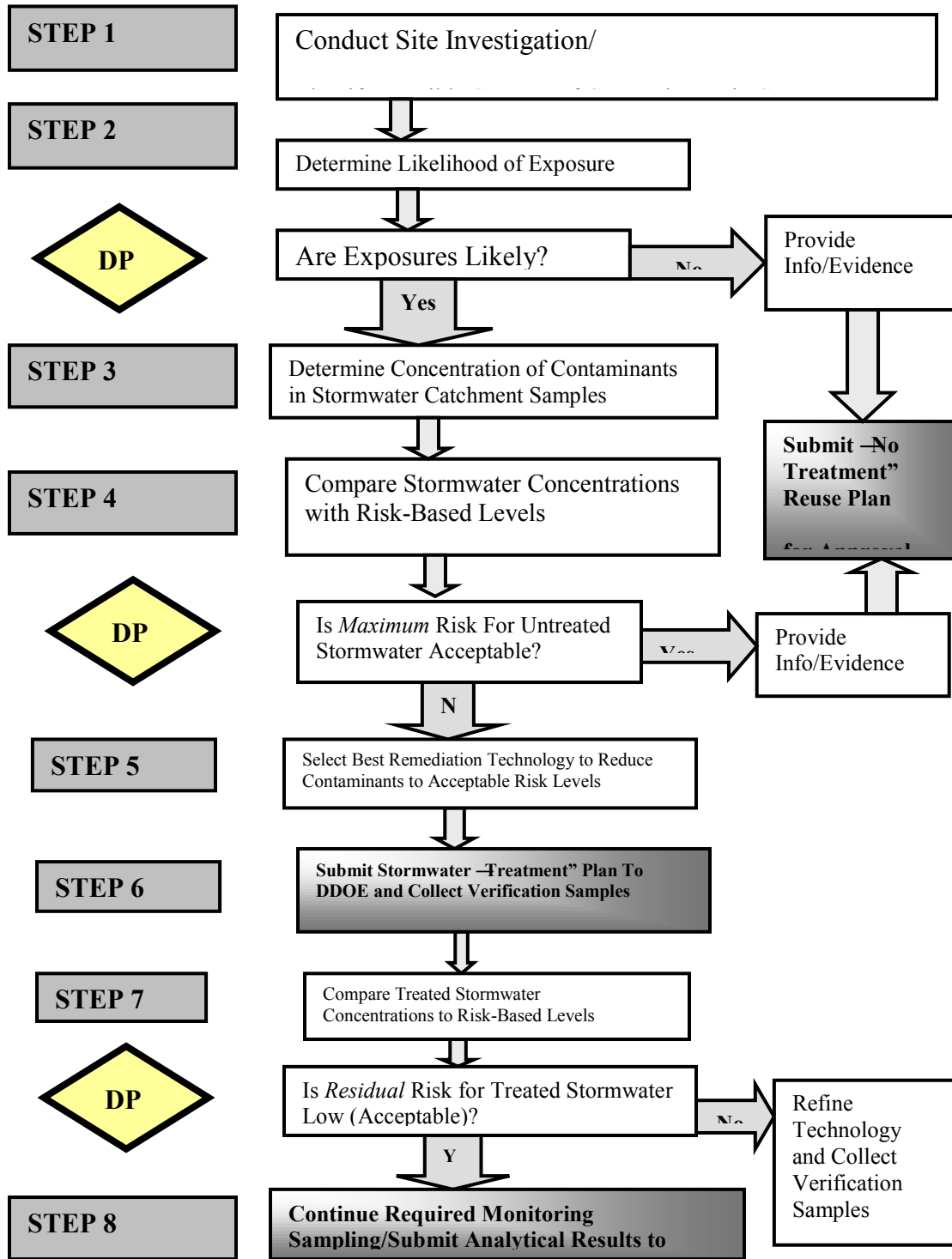
investigation will be a direct function of the site-specific conditions instead of a one-size-fits-all prescribed approach.

Figure 1 presents the TRAM decision-making framework. There are two important features of this framework that make it cost effective. First, investigative costs (including sampling and analysis) can be minimal for sites where there will be no human exposures to stormwater. Second, there are several exit points in the nine-step process at which investigations can be terminated and the proposed plan submitted to DDOE. The overall goal of the TRAM approach is to identify priorities as early as possible in the process to ensure public health will be protected. This requires the following:

- Identifying and documenting contaminant hazards and hazardous events;
- Estimating the likelihood that a hazardous event will occur;
- Estimating the consequences of the hazardous event occurring; and
- Characterizing the overall risk by combining the hazards and hazardous events with their likelihood and consequence.

Depending on the complexity of the site, these requirements may necessitate the following assessments:

- Initial screening-level risk assessment;
- An assessment of the maximum risk (in the absence of preventive measures); and
- An assessment of the residual risk (in the presence of preventive measures).



**Step 1: Conduct Site Investigation**

The goal of the initial site investigation is to identify potential contaminants that could enter the stormwater catchment and to characterize potential human exposures. This information will be used as the baseline investigation for subsequent steps in the TRAM approach. At minimum, the proposed plan must provide a general description of the site and any potential chemical or microbial contamination that may be present. Information should include:

- Site location and map showing all the properties within the proposed stormwater catchment system, in the simplest scenario this identification is the proposed roof area
- Zoning classification of all properties contributing to the stormwater catchment
- Total acreage of the stormwater catchment for the stormwater project
- Description of site property and surrounding areas based on available data and information. In the simplest scenario this is limited to an identification of the proposed roof materials and roof characteristics
- Description of any portion of the site regulated under the Resource Conservation and Recovery Act (RCRA), Superfund Program, or any other environmental investigation by the District of Columbia or the Environmental Protection Agency
- The current status of any ongoing or unresolved Consent Orders, Compliance Agreements, Notices of Violation (NOV), or other activities
- Schematic showing the location of sewer manholes
- Location of any obvious chemical spill residue (e.g., discolored soil, die-back of vegetation, etc.)
- Location of all aboveground or underground storage tanks
- Planned future uses of the site

If the site is zoned industrial, and the proposed catchment area contains surfaces other than the a proposed roof area, it will be necessary to conduct a more robust baseline investigation than for other types of properties to determine if chemical or microbial contamination is present. For sites zoned industrial, all potential chemical contaminants that were used, stored, or released on the property must be identified.

On sites where the catchment area includes surfaces beyond a proposed roof the receiving environment for all stormwater in the catchment must be characterized. All sources of variation due to seasonal and diurnal effects, as well as major rain events, must be characterized. This baseline information is very important because it provides a point of reference for evaluating untreated stormwater. It will also be important to determine whether validation and/or verification sampling or monitoring is warranted.

Stormwater contaminants detected in catchment can be due to both roof water runoff and contamination of soil within the area stormwater will be collected. Therefore, when existing roof areas and other existing surfaces will contribute to the proposed rainwater harvest system the existing roof systems must be inspected, and land use must be characterized as part of the proposal process.

Some of the important roof characteristics include the following:

- Whether vehicular traffic is allowed (i.e., parking structures)
- Whether there are overflow or bleed-off pipes from roof-mounted appliances, such as air conditioning units, hot water services, and solar heaters that will contribute to the collection area
- Whether any flues or smoke stacks from heaters, boilers, or furnaces could have contaminated roof surfaces
- Whether the roof is covered with lead flashing or exposed areas painted with lead-based paints
- Whether the roof is covered with a vegetated roof system

A short narrative of how the property has historically been used must also be provided if the proposed collection areas include existing land surfaces and information is available. This land use description is very important because some land uses have been shown to be associated with high contaminant levels. Land uses of particular interest include the following:

- Industrial land uses can result in either widespread or point sources of contamination due to organic compounds and/or inorganic metals
- Runoff from major roads and freeways with high traffic volumes can contain relatively high levels of hydrocarbons and metals (particularly, lead)
- Residential areas that experience frequent sewer overflows

Plans must describe how the stormwater will be collected, stored, and used. This will provide important exposure information necessary to estimate potential threats to public health. At minimum, the plan must provide:

- How stormwater will be collected
- The total amount of stormwater that will be collected from each source (roof water, parking lots, etc.)
- How stormwater will be stored (aboveground cistern, belowground storage tank, etc.)
- Description of the end use(s) of stormwater (municipal irrigation, spray fountain, pool, etc.)
- List of all types of individuals who could potentially be exposed to stormwater under the intended use(s) (e.g., landscapers, maintenance workers, children, joggers, etc.)
- Age groups for all types of exposed individuals (e.g., children, adults, elderly)
- Estimated time (e.g., hours, days, years) each type of individual could be exposed to stormwater under its intended use
- List of activities the exposed individuals will be engage in onsite (recreational, sports, gardening, etc.)



- Type and routes of exposures for all exposed individuals (ingestion of sprays during irrigation, ingestion during car wash, ingestion of fruit and vegetables irrigated with stormwater, etc.)
- List of potential exposures associated with unintended stormwater uses (system malfunction, cross plumbing, etc.)
- List of sensitive populations that may be exposed (children, infirm, invalid, etc.)

The above information will form the basis for determining the likelihood of exposure in the next step and will also be used to characterize specific exposure conditions and routes of exposure in subsequent steps.

### ***Step 2: Determine Likelihood of Exposure***

One of the basic tenets of risk assessment states that, “~~Were~~ there is no exposure, there is no risk.” This truism is applicable even for sites where chemical or microbial contamination is elevated. Accordingly, the first step in the investigation for all stormwater projects is to determine the likelihood of exposure. As was indicated in Table N.1, exposures can be characterized as unlikely, possible, or likely based on reasonable assumption. That is, DDOE’s threshold will not be based on the possibility that exposures could occur, but rather on whether it is plausible exposures will occur. Information presented in Step 1 should form the basis for this determination. Making a determination that exposures are unlikely in this step is very important because no stormwater decontamination or disinfection will be required for those projects where exposure is unlikely. Untreated stormwater can be used as it was collected in these cases.

To make a determination that exposures are “~~unlikely~~” requires an evaluation of both intended and non-intended exposures. An example of unlikely exposure conditions would be a closed system with no intended exposures and less than approximately 50 unintended exposure events per year involving less than 1 milliliter exposure per isolated event. System malfunctions (breaches in the system, pipe bursts per year, tank leakage, cross connections, etc.) are the most likely types of unintended exposures. Likelihood of exposure should be based on the specific end use and the types of individuals who will visit the site.

### ***DECISION POINT 1: Are Exposures Likely?***

If the information submitted to DDOE is sufficient to support a determination that exposures are “~~unlikely~~,” no further study or analysis is required. This is the first exit point in the TRAM process (as was indicated in Figure 1). On the other hand, if exposure is “~~likely~~” or “~~possible~~,” the investigation must proceed to the next step.

### ***Step 3: Determine Concentration of Contaminants in Stormwater***

When human exposures are likely or possible, the maximum risk must be evaluated based on the concentration of both chemicals and pathogenic organisms. The maximum risk represents the threat to public health associated with potential exposures to untreated stormwater.

All chemicals identified and qualitatively evaluated in Step 1 should be targets in the sampling plan. If the catchment area in which stormwater will be collected is zoned industrial, it is possible that those chemicals identified in the baseline investigation may have contaminated roof

water, surface soil, or pavement. For areas considered open space or recreational properties, sampling for chemical contamination can be limited to pesticides.

Table N.4 lists chemicals typically associated with industrial operations, as well as common pesticides. Pathogenic microbes may also be present in collected stormwater, and Table 4 lists the three primary categories of microbial threats to human health, which are bacteria, viruses, and protozoa. Stormwater samples collected in this step should represent the conditions that will occur during a major rain event. Note, however, that the concentrations of chemicals and microbes will be lower after a major rain event compared with a minor rain event due to the dilution effect. Planning for the stormwater sampling event should take into account roof, soil, and solid surface contributions to the stormwater catchment system. All samples submitted for laboratory testing should represent, as closely as possible, the conditions in which untreated stormwater will be stored and used at the site. For example, if collected stormwater will be stored in a cistern shielded from light for several days before it is used, the samples sent for laboratory analysis must be stored under the same conditions (i.e., same temperature under dark conditions to assess growth of microbial pathogens). After replicating site storage conditions, all samples must be sent to an EPA-approved laboratory for analysis of all chemicals of interest identified in the baseline investigation.

The sampling locations and number of samples collected at this stage should be based on the size of the catchment area and sources of potential contamination. For example, a non-industrial site totaling 2 to 3 acres with only one storage cistern could be adequately represented by taking a minimum of three samples at timed intervals over a holding time of 4 to 5 days. At the other end of the spectrum, a 10-acre site located in an industrial area with several storage cisterns spread out over the site may require sampling from each cistern after moderate and major storm events. Regardless of the type of site, DDOE encourages implementation of the most cost-effective approach as the goal is not to fully characterize the site for potential contamination, but rather to determine if the contaminants in collected stormwater pose a health threat.

Sampling results generated in this step should be evaluated in the risk-based screening comparison described in the next step.

**Table N.4 Chemicals of Interest for Baseline Investigations**

Inorganic Metals		
Aluminum	Chromium	Selenium
Arsenic	Iron	Silver
Barium	Manganese	Tin
Beryllium	Mercury	Zinc
Bromate	Molybdenum	
Cadmium	Nickel	

Organic Compounds		
Acrylamide	Hexachlorobutadiene	Trichloroethylene
Benzene	Polyaromatic hydrocarbons	Trichloroethane
Carbon tetrachloride	Polybrominated biphenyls	Trichloroethene
Chlorobenzene	Polychlorinated biphenyls	Vinyl chloride monomer
Benzo[a]pyrene	Tetrachloroethene	Xylene
Epichlorohydrin	Toluene	
Ethylbenzene	Trichlorobenzenes	
Pesticides		
Aldicarb	Chlordane	
Aldrin	Diazinon	
Atrazine	Heptachlor	
Pathogenic Microbes		
Bacterium: <i>E. coli</i>		
Protozoan: <i>Cryptosporidium parvum</i>		

#### Step 4: Compare Stormwater Concentrations with Risk-Based Levels

To determine whether exposure to untreated stormwater is a public health threat, maximum risk must be assessed. Determining whether stormwater exposures will pose a threat does not require that a formal risk assessment be conducted. Risk assessments can be costly and time consuming to prepare. Instead, it will only be necessary to apply risk-based screening, and DDOE has even simplified this step. Screening involves a simple comparison of the chemical and/or microbial concentrations detected in untreated stormwater (in the previous step) with acceptable risk-based screening levels. Risk-based concentrations represent safe exposure levels for chemical or microbial contaminants. They are derived based on the frequency of exposure, amount ingested, and the inherent toxicity of each contaminant.

Table N.5 lists different types of stormwater use that DDOE anticipates in the District. For each stormwater use, there could be several types of exposure conditions that vary in exposure intensity and duration. For example, individuals engaged in high-intensity sports (e.g., baseball, football, soccer, etc.) would have greater exposures to contaminants in stormwater used for irrigation at a municipal park than would someone walking a pet.

**Table N.5 Types of Stormwater Use and Routes of Exposure**

Stormwater Use	Route of Exposure	General Description of Exposure Conditions
Home lawn or garden spray irrigation	Ingestion of aerosol spray	Typical watering every other day during half year
	Ingestion after contact with plants/grass	Routine indirect ingestion via contact with plants, lawns, etc.
	Accidental ingestion of stormwater	Infrequent inadvertent ingestion.

Stormwater Use	Route of Exposure	General Description of Exposure Conditions
Open space or municipal park drip or spray irrigation	Ingestion via casual contact (picnic, walking pet)	Infrequent contact with wet grass, picnic tables
	Ingestion via low-intensity sports (golf, Frisbee)	Typical contact with irrigated plants/grasses
	Ingestion via high-intensity sports (baseball, soccer)	Frequent contact with irrigated sports field
	Ingestion by child on playground	Frequent contact with wet surfaces and frequent hand-to-mouth activity
	Public fountain with spray element	Indirect and infrequent ingestion of spray
	Public fountain with standing pool	Infrequent ingestion of pool water during hot days
Home garden drip or spray irrigation	Ingestion of irrigated vegetables and fruit	Typical ingestion of small home garden seasonal produce
Commercial farm produce drip or spray irrigation	Ingestion of irrigated vegetables and fruit	Typical ingestion of regional commercial produce
Home car wash spray application	Ingestion of water and spray	Once a week car wash for 6 months
Commercial car wash spray	Ingestion of water and spray	Car wash operator exposed 5 days per week
Toilet	Ingestion of aerosol spray	Flushing 3 times per day
Washing machine use	Ingestion of sprays	Ingestion from 1 load per day
Fire fighting	Ingestion of water and spray	Firefighter assumed exposed 50 events per year

Table N.6 lists the exposure assumptions that represent different types of stormwater use and the corresponding typical exposure conditions for each use. Project planners should identify the appropriate exposure conditions in this table that most closely match site-specific conditions. Stormwater use and the site-specific exposure conditions correspond to specific assumptions regarding how individuals will come in contact with untreated stormwater. The two most important criteria are the number of days contact is expected to occur and the volume of stormwater that will be ingested on each of those days.

For example, the first row indicates that an individual watering a lawn or garden is assumed to do so every other day for 6 months and will ingest 0.1 ml of stormwater each time the lawn is watered. While DDOE anticipates that these exposure assumptions will represent the majority of sites, a small number of reuse projects may be unique, and DDOE should be contacted to discuss unique sites. For these projects, planners should either contact DDOE directly to discuss alternative exposure assumptions or select an exposure scenario that is intentionally conservative. Although this may be an overly protective approach, such a comparison would be sufficient proof for DDOE that public health will be protected if the site passed the risk-based screen test.

**Table N.6 Exposure Assumptions Based on Stormwater Use and Exposure Conditions**

Stormwater Use	Route of Exposure	Exposure Assumptions	
		Volume Ingested (mL)	Days (per year)
Home lawn or garden spray irrigation	Ingestion of aerosol spray	0.1	90
	Ingestion after contact with plants/grass	1	90
	Accidental ingestion of stormwater	100	1
Open space, municipal park drip, or spray irrigation	Ingestion with casual contact-picnic, walking pet	0.1	32
	Ingestion with low intensity sports-golf, Frisbee	1	32
	Ingestion high intensity sports-baseball, soccer	2.5	16
	Ingestion child playground	4	130
	Public fountain with spray element	0.1	130
	Public fountain with standing pool	4	130
Home garden drip or spray irrigation	Ingestion of irrigated vegetables and fruit	7	50
Commercial farm produce drip or spray irrigation	Ingestion of irrigated vegetables and fruit	10	140
Home car wash spray application	Ingestion of water and spray	5	24
Commercial car wash spray	Ingestion of water and spray	3	250
Toilet	Ingestion of aerosol spray	0.01	1100
Washing machine use	Ingestion of sprays	0.01	365
Fire fighting	Ingestion of water and spray	20	50
Swimming pool	Ingestion of water	200	90

It should be stressed that although EPA and several state regulatory agencies have developed RSLs (EPA RSLs available at [http://www.epa.gov/reg3hwmd/risk/human/rb-concentration\\_table/equations.htm](http://www.epa.gov/reg3hwmd/risk/human/rb-concentration_table/equations.htm)), these should not be used for stormwater projects. These RSLs apply only to potable drinking water and, because they are overly conservative, many stormwater projects would fail the screen. Stormwater collected in the District must never intentionally or unintentionally be used as a potable drinking water source. Therefore, EPA's RSLs for drinking water, which are based on the assumption that a child and an adult will drink 1 and 2 liters of water per day, respectively, are not applicable to stormwater reuse projects. Furthermore, the drinking water RSL assumes an individual will drink the water 350 days per year for 30 years. This corresponds to 350 to 700 liters of water consumed per year, which is 500 to 1,000 times the amount of stormwater that will be ingested for most projects (as shown in Table N.6). Clearly, drinking water exposure assumptions do not represent typical stormwater reuse exposures and should not be used to screen for the maximum risk.

DDOE has made the risk-based screening step easy to use by evaluating the exposure conditions presented in Table N.6, ranking the intensity of each type of exposure and grouping exposures

with similar intensity into one of four categories: severe, high, medium, or low. The exposure scenarios (listed in Table N.6) for each of these categories are presented in Table N.7.

**Table N.7 Categorizing Exposures Based on Stormwater Use: Severe, High, Medium, and Low**

Exposure Classification	Exposure Classification	Route of Exposure
Severe	Swimming pools	Ingestion of water
High	Commercial farm produce drip or spray irrigation	Ingestion of irrigated vegetables and fruit
	Fire fighting	Ingestion of water and spray
	Commercial car wash	Ingestion of water and spray
Medium	Open space or municipal park drip or spray irrigation	Ingestion by child on playground
	Open space or municipal park drip or spray irrigation	Public fountain with standing pool
	Home garden drip or spray irrigation	Ingestion of irrigated vegetables and fruit
	Home car wash spray application	Ingestion of water and spray
	Home lawn or garden spray irrigation	Accidental ingestion of stormwater
	Home lawn or garden spray irrigation	Ingestion after contact with plants/grass
Low	Open space or municipal park drip or spray irrigation	Ingestion via high-intensity sports—baseball, soccer
	Open space or municipal park drip or spray irrigation	Ingestion via low-intensity sports—golf, Frisbee
	Open space or municipal park drip or spray irrigation	Public fountain with spray element
	Toilet	Ingestion of aerosol spray
	Home lawn or garden spray irrigation	Ingestion of aerosol spray
	Washing machine use	Ingestion of sprays
	Open space or municipal park drip or spray irrigation	Ingestion with casual contact—picnic, walking pet

Project planners should select one of these four categories that best represent site-specific conditions. The selection should be based on how stormwater will be used, who will contact the stormwater, and by what route of exposure. For example, stormwater used to fill a swimming pool is ranked “severe” because the frequency of exposure combined with the high rate of ingestion of pool water while swimming is considerably greater than all other exposures. It should be noted that exposure assumptions for formal risk assessments are typically established

with worst possible exposure assumptions. While the worst exposure may be hypothetically possible, DDOE expects projects to rely on realistic and common sense expectations. For this reason, detailed and complex “future exposure analyses” are unnecessary. Proposals need only submit sufficient information to allow DDOE to convey to the public that a thorough analysis has been performed and that public health is being protected.

Although exposure assumptions are typically based on broad “what if” hypothetical scenarios in formal risk assessments, DDOE encourages proposals that are based on realistic expectations to determine the most likely threats to public health. DDOE recognizes that, in many cases, the anticipated exposure conditions will be based on subjective judgment rather than on a detailed complex “future hypothetical exposure” analysis. Accordingly, proposals need only submit sufficient information to show that all potential exposures have at least been considered. This will allow DDOE to convey to the public that a thorough analysis has been performed and that public health is being protected.

In addition to the obvious and planned stormwater use, proposals must also consider inadvertent or unauthorized use of stormwater. That is, while the major focus should be on the intended uses, it is important to consider exposures that could result from inadvertent use of untreated stormwater as it may result in higher-than-intended exposure to humans and the receiving environment. For example, even though the intended use of stormwater may be for non-drinking purposes, such as irrigation of parks and gardens, people may occasionally drink from a recycled water tap by accident. Obviously, a failsafe system must be put in place to prevent this from occurring. However, preventive measures can sometimes be circumvented, and the plan should evaluate the exposure as a low-probability event to determine the magnitude of the potential threat to public health in the event of occurrence.

DDOE has derived RSLs for all the chemicals that are routinely detected in environmental media, particularly at industrial sites, which were presented in Table N.4. It is impractical to derive RSLs for all possible combinations of chemicals and for all stormwater uses and exposure conditions, but this list should be the starting point for sampling efforts. However, if the baseline investigation provides sufficient evidence that chemical contamination at the site is unlikely, sampling may be unnecessary. DDOE recognizes that sampling and laboratory analyses can be expensive and time consuming and may not be warranted. For example, if the property is currently and has always been zoned for residential use, there may be no reason to suspect a chemical release has occurred. In this situation, the planner could submit the baseline investigation and justification for a waiver to sample, which DDOE would review and consider.

The RSLs that should be used for risk-based screening are presented in Table N.8. These levels represent the acceptable concentrations corresponding to either a cancer risk of 1E-6 or noncancer hazard index of 1.0. They correspond to the site-specific end use of the stormwater and exposure conditions as discussed previously. EPA’s risk management framework states that a risk level between 1E-6 and 1E-4 is a discretionary range. The reason DDOE selected a risk-based screening level for cancer risk of 1E-6 is that it is likely that multiple chemicals will be detected for some projects. DDOE will use discretion in setting the acceptable “cumulative” risk level for projects where the individual contaminant levels slightly exceed the concentrations presented in Table N.8.

To use the table, planners only need to identify the column that matches the site-specific exposure category and identify the row corresponding to the chemical of interest. That sample concentration is then compared with the RSL. If the sample concentration is below the RSL, it can be concluded stormwater does not pose a threat to human health, and no further action is necessary. If the sample concentration exceeds the RSL, the analysis must continue on to the next step in the TRAM process as described in the next section.

**Table N.8 Risk-based Chemical Concentrations for Sites Categorized as Severe, High, Medium, and Low Exposures**

Chemical (µg/L)	Drinking Water	Exposure Category			
		Severe	High	Medium	Low
Acrylamide	4.3E-02	1.6E+00	2.2E+01	5.8E+01	6.3E+02
Aldicarb	3.7E+01	1.3E+03	1.8E+04	4.9E+04	5.3E+05
Aldrin	4.0E-03	1.5E-01	2.0E+00	5.4E+00	5.8E+01
Aluminum	3.7E+04	1.3E+06	1.8E+07	4.9E+07	5.3E+08
Arsenic, Inorganic	4.5E-02	1.6E+00	2.3E+01	6.1E+01	6.6E+02
Atrazine	2.9E-01	1.1E+01	1.5E+02	3.9E+02	4.2E+03
Barium	7.3E+03	2.7E+05	3.7E+06	9.8E+06	1.1E+08
Benzene	4.1E-01	1.5E+01	2.1E+02	5.5E+02	6.0E+03
Benzo[a]pyrene	2.0E-01	7.3E+00	1.0E+02	2.7E+02	2.9E+03
Beryllium	7.3E+01	2.7E+03	3.7E+04	9.8E+04	1.1E+06
Bromate	9.6E-02	3.5E+00	4.8E+01	1.3E+02	1.4E+03
Cadmium	1.8E+01	6.7E+02	9.1E+03	2.5E+04	2.7E+05
Carbon Tetrachloride	4.4E-01	1.6E+01	2.2E+02	5.9E+02	6.4E+03
Chlordane	1.9E-01	6.9E+00	9.5E+01	2.6E+02	2.8E+03
Chlorobenzene	9.1E+01	2.7E+04	3.7E+05	9.8E+05	1.1E+07
Chromium	4.3E-02	4.0E+03	5.5E+04	1.5E+05	1.6E+06
Diazinon	2.6E+01	9.3E+02	1.3E+04	3.4E+04	3.7E+05
Epichlorohydrin	2.1E+00	8.0E+03	1.1E+05	2.9E+05	3.2E+06
Ethylbenzene	1.5E+00	5.5E+01	7.5E+02	2.0E+03	2.2E+04
Heptachlor	1.5E-02	5.5E-01	7.5E+00	2.0E+01	2.2E+02
Hexachlorobutadiene	8.6E-01	3.1E+01	4.3E+02	1.2E+03	1.3E+04
Iron	2.6E+04	9.3E+05	1.3E+07	3.4E+07	3.7E+08
Manganese	8.8E+02	3.2E+04	4.4E+05	1.2E+06	1.3E+07
Mercury	1.1E+01	4.0E+02	5.5E+03	1.5E+04	1.6E+05
Molybdenum	1.8E+02	6.7E+03	9.1E+04	2.5E+05	2.7E+06
Nickel	1.8E+03	6.7E+04	9.1E+05	2.5E+06	2.7E+07
Polybrominated Biphenyls	2.2E-03	8.0E-02	1.1E+00	3.0E+00	3.2E+01
Polychlorinated Biphenyls	5.0E-01	1.8E+01	2.5E+02	6.7E+02	7.3E+03
Selenium	1.8E+02	6.7E+03	9.1E+04	2.5E+05	2.7E+06



Chemical (µg/L)	Drinking Water	Exposure Category			
		Severe	High	Medium	Low
Silver	1.8E+02	6.7E+03	9.1E+04	2.5E+05	2.7E+06
Tetrachloroethylene	1.1E-01	4.0E+00	5.5E+01	1.5E+02	1.6E+03
Tin	2.2E+04	8.0E+05	1.1E+07	2.9E+07	3.2E+08
Toluene	2.3E+03	1.1E+05	1.5E+06	3.9E+06	4.3E+07
Trichlorobenzene	2.3	8.4E+01	1.2E+03	3.1E+03	3.4E+04
Trichloroethane	2.4E-01	8.8E+00	1.2E+02	3.2E+02	3.5E+03
Trichloroethane	9.1E+03	2.7E+06	3.7E+07	9.8E+07	1.1E+09
Trichloroethylene	2.0	7.3E+01	1.0E+03	2.7E+03	2.9E+04
Vinyl Chloride	1.6E-02	5.8E-01	8.0E+00	2.2E+01	2.3E+02
Xylene	2.0E+02	2.7E+05	3.7E+06	9.8E+06	1.1E+08
Zinc	1.1E+01	4.0E+02	5.5E+03	1.5E+04	1.6E+05

Stormwater projects must also include an evaluation of threats from microbial pathogens. Although this can be a complex investigation (there are many hundreds of different microbial pathogens), DDOE has developed a tiered approach to reduce time and costs based on the indicator pathogens *Escherichia coli* (*E. coli*) and *Cryptosporidium parvum* (*C. parvum*). With this approach, planners should first monitor for *E. coli* because it is less expensive to analyze than *Cryptosporidium*. *E. coli* is termed a reference or indicator microbe because it is associated with human and wildlife fecal waste (it should be noted, however, that no simple statistical correlation exists between *E. coli* and human pathogen concentrations in stormwater). *C. parvum*, however, causes gastrointestinal illness that may be severe and sometimes fatal for people with weakened immune systems (which may include infants, the elderly, and individuals who have AIDs). It will only be necessary to monitor for *C. parvum* if the *E. coli* results exceed the RSLs presented in Table N.9, if the stormwater storage system is large and at ground level, or stormwater is stored in a reservoir.

Table N.9 presents RSLs for *E. coli* that are based on EPA guidance for swimming and wading (Ambient Water Quality Criteria for Bacteria (EPA440/5-84-002 January 1986). The current level that is acceptable for swimming and wading is 160 CFU/100mL, which corresponds to a risk of developing gastroenteritis of 8 in 1000 and is generally accepted as a safe level by regulatory agencies. This formed the basis for the “severe” category and was also used to derive the RSL for the three other categories using the attenuated exposure assumptions presented in Table N.6. For sites classified as severe exposures, the RSL should be interpreted to mean that when the site sample concentration for *E. coli* < 160 CFU/100mL, the stormwater is safe for swimming or wading, and no further action is necessary for microbial contaminants. If this RSL is exceeded, however, samples must be collected for the next tier, which involves analyzing for *C. parvum*.

Unlike *E. coli*, no regulatory agency has yet to develop a safe level for *C. parvum* exposure. Although the EPA’s recently revised new Long Term 2 Enhanced Surface Water Treatment Rule (LT2 rule; EPA 815-R06-006 February 2006) stresses the importance of monitoring for *C. parvum* to protect drinking water sources, no exposure-specific RSL is available. It should be

noted, however, that DDOE’s approach for monitoring microbial contaminants is similar to the strategy in the LT2 rule, because DDOE concurs with EPA that a tiered monitoring approach based on *E. coli* and *C. parvum* is the most cost-effective strategy for protecting the public from gastrointestinal illness.

Table N.9 presents RSLs for each exposure category for *C. parvum*. These levels were developed based on the WHO approach using Disability Adjusted Life Years (DALYs); they are also consistent with the tolerable levels developed in Australian Guidelines For Water Recycling: Managing Health And Environmental Risks (Phase 2) Stormwater Harvesting And Reuse (July 2009) and are set at 1E-6 risk level.

**Table N.9 Risk-Based Microbial Levels for Sites Categorized As Severe, High, Medium, and Low Exposures**

Microbial Pathogen	Swimming	Exposure Category			
		Severe	High	Medium	Low
<i>Escherichia coli</i> (CFU/100 mL)	126 <sup>1</sup>	126	1714	4615	50000
<i>Cryptosporidium</i> <sup>2</sup> (oocysts/L)	NA	0.001	0.016	0.033	0.320

<sup>1</sup> Ambient Water Quality Criteria for Bacteria (EPA440/5-84-002 January 1986). RSLs correspond to a risk level of 8 in 1,000 of developing a gastrointestinal disease.

<sup>2</sup> Australian Guidelines for Water Recycling: Managing Health and Environmental Risks (Phase 2) Stormwater Harvesting and Reuse. July 2009. RSLs correspond to a 1E-6 risk level of developing a gastrointestinal disease.

The risk-based screening results for both chemicals and microbes are considered in the next step.

**DECISION POINT 2: Is Maximum Risk for Untreated Stormwater Acceptable?**

This step represents the important risk management decision point in the TRAM approach and it is dependent on the previous risk-screening comparison. The comparison of chemical and microbiological contaminant levels with RSLs is the only criteria needed to make this determination. This is a pivotal decision, since if the maximum risk is acceptable, no further investigation is necessary, stormwater treatment will not be required, and the proposed plan for no treatment can be submitted to DDOE for review. This represents the second exit point from the TRAM process.

On the other hand, if one or more contaminants fail the risk-based screen, action will generally be necessary to lower risks to an acceptable level. The magnitude of the exceedance will be the primary determinant for making risk management decisions. If the exceedance is less than one or two orders of magnitude, DDOE can exercise its discretion about the best path forward and whether a treatment system is necessary. DDOE will rely on factors such as availability of treatment systems, severity of the toxic effect, probability of exposures, and whether measures can be implemented to prevent exposures. DDOE’s determination will ultimately be based on a cost-benefit evaluation, and the most effective remedy with the lowest cost will be selected.

If the appropriate remedy is treatment, planning should proceed to the next step.

***Step 5: Select Appropriate Treatment Technology to Reduce Contaminants to Acceptable Risk Levels***

Selecting the appropriate remedy will depend on the type(s) of contaminant(s) posing the health threat. For microbial pathogens in small-to-medium sized stormwater projects, ultraviolet (UV) disinfection is the most practical and cost effective approach. Although chlorination may also be suitable, protozoa such as *C. parvum* will require a higher Ct value (disinfectant concentration × contact time) because inactivation is more difficult to achieve compared with that for bacteria and viruses.

If chemical contaminants pose an unacceptable risk, it must be determined whether they are soluble or are bound to particles. If they are particulate-bound, it may be necessary to reduce their concentration with filtration, flocculation, or other treatments that reduce suspended solids.

Proposed plans must present the type of treatment selected that will target specific chemical and/or microbial risks. Planning should proceed to the next step.

***Step 6: Submit Stormwater “Treatment” Plan to DDOE and Collect Verification Samples***

Proposed plans must provide a full description of the treatment system that is selected to reduce contaminant levels. The operating efficiency and specifications are necessary because verification samples will be used to validate the system is operating as designed.

The design of a monitoring program will be specific to each project, but it must take into account both peak and average rainfall. The point of compliance will be the stormwater in the catchment rather than separate points across the property because the catchment water represents the average of all contributions because it is likely that one or more individual samples will fail risk-based screening. The extent of sampling required to verify the system is functioning properly will be project-specific with more extensive sampling required for projects where a greater number of individuals are exposed to chemicals that are considered more toxic. As a rule of thumb, projects classified as “severe” and “high” will require a slightly more complex sampling design. Also, projects that require a higher log reduction of contaminant levels will receive a greater degree of scrutiny.

***Step 7: Compare Treated Stormwater Concentrations with Risk-Based Levels***

The log reduction necessary to achieve acceptable risk levels represents the difference between the maximum (untreated stormwater) and residual (treated stormwater) risk. Sample concentrations should be < the target concentrations corresponding to the intended use and exposures, and those target goals are the same RSLs that were presented in Tables N.8 and N.9.

***DECISION POINT 3: Residual Risk for Treated Stormwater Acceptable?***

This step requires that a decision be made as to whether the treatment system efficiently reduced contaminant levels to acceptable concentrations. If the verification samples indicate the treatment system is performing as designed, the proposal must include the results and conclusions and proceed to the next step. As noted previously, DDOE will use discretion in determining whether

the project meets the acceptable “cumulative” risk level for projects where the individual contaminant levels slightly exceed the concentrations presented in Table N.8. For example, DDOE may determine that exceedances do not rise to a level requiring action if the number of potentially exposed individuals is very small. Additionally, DDOE may use its discretion to waive action when an exceedance is less than an order of magnitude above risk-based screening levels.

If the treatment system fails to meet the design specifications and cannot achieve the required risk-based acceptable concentrations, the investigation must go back to Step 7 and repeat the subsequent steps of the TRAM process. This requires that either the selected treatment system be modified or an alternate technology selected.

***Step 8: Continue Required Monitoring Sampling/Submit Analytical Results to DDOE***

The purpose of a monitoring program is to confirm continued compliance with the required end use water standards. The applicant will submit a post construction monitoring program that will access the ongoing lifecycle compliance including annual verification of performance as well as performance verification after significant maintenance or modifications to the treatment system. Monitoring assesses:

- Overall performance of the systems harvesting stormwater for non-potable uses;
- Quality of the harvested stormwater being supplied or discharged;
- Changes in the receiving environment or exposed populations.

Ultimately, the goal of monitoring is to provide continued assurance that the treatment system is operating at levels specified in the permit and public health is being protected. For example, systems relying on UV radiation for disinfection would need to replace the UV source at pre-specified intervals, and monitoring should be conducted soon after the unit is replaced. The original proposal must present a detailed monitoring plan that anticipates routine maintenance or major modification to treatment systems. As a rule of thumb, greater emphasis on monitoring will be necessary for those projects where the exposed population is significant and/or the maximum risks associated with untreated stormwater are significantly above risk-based levels. This monitoring program will be part of the approved SWMP and detailed in the deed of covenants as part of the BMP’s long term maintenance obligations.

# Appendix O Land Cover Designations

## O.1 General Notes

The retention standard approach taken in this guidance manual for onsite stormwater management recognizes the ability of pervious land covers to manage some, or all, of the rainwater that falls on it. This is termed land abstraction in this appendix. The concept is discussed as “existing retention” in chapters and appendices on the off-site retention program. To facilitate the design, review, construction and enforcement of site designated land cover, land abstraction has been divided into two types of land covers, natural cover and compacted cover. In this guidance manual the preservation of existing land covers in either of these designation, as well as the creation of land covers with either of these designation, are treated equally. The designation of natural cover assumes these lands will generate zero stormwater runoff for a design rain event. The designation of compacted cover assumes these lands will generate 25 percent stormwater runoff for a design rain event. The minimum area threshold for the natural cover designation is 1500 square feet, with a minimum shortest length of 30 feet. All land cover designations must be recorded in the declaration of covenants.

## O.2 Existing Natural Cover Requirements

A site claiming natural cover based on the preservation of existing conditions must ensure conditions remain undisturbed to preserve hydrologic properties equal to or better than meadow in good condition. Preservation areas for natural cover may include:

- Portions of residential yards in forest cover that will not be disturbed during construction.
- Community open space areas that will not be mowed routinely, but left in a natural vegetated state (can include areas that will be rotary mowed no more than two times per year)
- Utility rights-of-way that will be left in a natural vegetated state (can include areas that will be rotary mowed no more than two times per year)
- Other areas of existing forest and/or open space that will be protected during construction and that will remain undisturbed

## O.3 Planting Requirements for the Creation of Natural Cover

Every 1500 square feet of created natural area shall be vegetated according to the following options of plant material quantity:

- 1 native shade tree: 1.5 inch caliper (minimum), or
- 2 native ornamental trees: 6 foot height (minimum), or
- 6 native shrubs: 5 gallon container size (minimum), or
- 50 native perennial herbaceous plants: 1 gallon container size (minimum), or

- 1 native ornamental tree: 6- to 10-foot height (minimum), and 25 native perennial herbaceous plants: 1 gallon container size (minimum), or
- 3 native shrubs: 5 gallon container size (minimum), and 25 native perennial herbaceous plants: 1 gallon container size (minimum), or
- Steep slope greater than 6 percent grade will require additional plantings, soil stabilization, or a terracing system.
- Whip and seedling stock may be used (when approved by DDOE) as a site's natural cover creation if a stream bank stabilization opportunity falls within the site's footprint. In this instance, whips or seedlings must be planted at a minimum density of 700 plants per acre, and at least 55 percent of these plants must remain at the end of the 2-year management period.
- Using natural regeneration, i.e., allowing volunteer plants to propagate from surrounding natural cover as a cover creation technique, may be allowed by DDOE, when 75 percent of the proposed planting area is located within 25 feet of adjoining forest, and the adjoining forest contains less than 20 percent cover of invasive exotic species. In this case, supplemental planting must ensure a density of 400 seedlings per acre.
- All plant materials used must be native to the mid-Atlantic region and must be installed in areas suitable for their growth. Lists of native species of shrubs, grasses and wildflowers are published in the US Fish and Wildlife Service, 2009, Native Plants for Wildlife Habitat and Conservation Landscaping: Chesapeake Bay Watershed. There are several websites that may be consulted to select the most appropriate plantings for the District;
  - ◆ <http://www.wildflower.org/collections/collection.php?collection=DC>
  - ◆ <http://www.nps.gov/plants/pubs/nativesMD/pdf/MD-CoastalPlain.pdf>
  - ◆ <http://www.nps.gov/plants/pubs/nativesMD/pdf/MD-Piedmont.pdf>
- Plants can be irrigated until established.

#### **O.4 Stormwater Management Plans and Natural Cover**

Sites using preservation of existing areas for the natural cover designation shall include on their Stormwater Management Plan (SWMP) a tree and vegetation survey, identification of location and extent of preservation areas. Depending on the extent of the preservation area DDOE may require the SWMP include a more detailed schedule for retained trees noting tree species, tree size, tree canopy, tree condition, tree location.

The SWMP will include the identification of material and equipment staging areas, and parking areas. Material and equipment staging areas and parking areas must be sufficiently offset for preservation areas to ensure no adverse impacts.

For areas maintained as meadow conditions, the SWMP shall document either the preservation of existing conditions or the creation of meadow conditions. Plan submission claiming meadow preservation will note the existing meadow boundaries; include a field survey of existing plant species richness and diversity, and existing soil conditions. Plan submission claiming meadow

creation will note the proposed meadow boundaries, the planting and/or seeding species methods, and provide a soil amendments plan following Appendix K.

## **O.5 Construction Requirements for Natural Cover Designation**

The preservation of lands designated as natural cover such as undisturbed portions of yards, community open space, and any other areas designated on a site's Stormwater Management Plan (SWMP) as preserved natural cover, must be shown outside the limits of disturbance on the site's Soil Erosion and Sediment Control Plan (SESCP) and clearly demarked on the site during construction with fencing and signage prior to commencement of construction.

The creation of lands designated as natural cover as part of a public right-of-way (PROW) project and on sites where soils were not protected from compaction during construction the soils must be conditioned prior to planting with soil compost amendments as prescribed in Appendix K.

For maximum survivability, planting of trees and shrubs and herbaceous vegetation for the creation of natural cover should occur only during the fall and early spring (September–November and March–May). The work should be done only under the supervision of someone qualified and skilled in landscape installation (see Section 3.14 Tree Planting and Preservation and Appendix J for details on qualifications). Proper maintenance of the materials after installation will be a key in whether the plants survive. Prior to inspection, all trees and shrubs planted must be alive and in good health; native grass and wildflower seeds must have been sown at adequate densities and at the right time of year for each species.

Once "natural cover" has been assigned to a portion of regulated development site that area will need to be recorded in the declaration of covenants, documented at the site prior to construction activities, protected during construction activities and permanently protected/maintained for the life of the regulated site.

Root pruning and fertilizing are examples of preconstruction activities. These measures aim to increase the wellbeing of trees and prepare them for higher stress. Prior to beginning construction, temporary devices such as fences or sediment controls are installed and remain throughout the construction phase. Some devices, like retaining walls and root aeration systems may stay for good. For example, if part of a root system is collapsed by a built road, permanent aeration may be necessary for the tree to remain healthy.

## **O.6 Maintenance Requirements for Natural Cover Designation**

All areas that will be considered natural cover for stormwater purposes must have documentation that prescribes that the area will remain in a natural, vegetated state. Appropriate documentation includes: subdivision covenants and restrictions, deeded operation and maintenance agreements and plans, parcel of common ownership with maintenance plan, third-party protective easement, within PROW or easement with maintenance plan, or other documentation approved by DDOE. Natural Cover designation must be identified in the site's declaration of covenants.

While the goal is to have natural cover areas remain undisturbed, some activities may be prescribed in the appropriate documentation, as approved by DDOE, such as forest management, control of invasive species, replanting and revegetation, passive recreation (e.g., trails), limited bush hogging to maintain desired vegetative community, etc.

### **O.7 Compacted Cover Designation**

The compacted cover designation can apply to all site areas that are disturbed and/or graded for eventual use as managed turf or landscaping. Examples of compacted cover include lawns, portions of residential yards that are graded or disturbed, and maintained as turf, including yard areas, residential utility connections, and public right-of-way. Landscaping areas intended to be maintained in vegetation other than turf within residential, commercial, industrial, and institutional settings are also considered compacted cover if regular maintenance practices are employed.



# **Appendix P      Geotechnical Information Requirements for Underground BMPs**

## **P.1    General Notes Pertinent to All Geotechnical Testing**

A geotechnical report is required for all underground stormwater Best Management Practices (BMPs), including infiltration-based practices, filtering systems, and storage practices, as well as stormwater ponds and wetlands. The following must be taken into account when producing this report.

- Testing is to be conducted by a qualified professional. This professional shall either be a registered professional engineer, soils scientist, or geologist and must be licensed in the District of Columbia.
- Soil boring or test pit information is to be obtained from at least one location on the site. However, the location, number, and depth of borings or test pits shall be determined by a qualified professional, and be sufficient to accurately characterize the site soil conditions.
- Depth to the ground water table and estimated depth to the seasonally high ground water table must be included in the boring logs/geotechnical report.
- Laboratory testing must include grain size analysis. Additional tests such as liquid limit and plastic limit tests, consolidation tests, shear tests and permeability tests may be necessary based on the discretion of the qualified professional.
- The geotechnical report must include soil descriptions from each boring or test pit, and the laboratory test results for grain size. Based upon the proposed development, the geotechnical report may also include evaluation of settlement, bearing capacity and slope stability of the proposed structures.
- All soil profile descriptions should provide enough detail to identify the boundary and elevations of any problem (boundary/restrictions) conditions such as fills and seepage zones, type and depth of rock, etc.

In addition to the testing requirements described above, infiltration tests must be performed for all BMPs in which infiltration will be relied upon, including permeable pavement systems, bioretention, infiltration, and dry swales. Specific requirements for infiltration testing are discussed below.

## **P.2    Initial Feasibility Assessment**

The feasibility assessment is conducted to determine whether full-scale infiltration testing is necessary, screen unsuitable sites, and reduce testing costs. However, a designer or landowner

may opt to skip the initial feasibility assessment at his or her discretion, and begin with soil borings.

The initial feasibility assessment typically involves existing data, such as the following:

- On-site septic percolation testing, which can establish initial rate, water table, and/or depth to bedrock;
- Previous geotechnical reports prepared for the site or adjacent properties.; or
- Natural Resources Conservation Service (NRCS) Soil Mapping.

If the results of initial feasibility assessment show that a suitable infiltration rate (typically greater than 0.5 inches per hour) is possible or probable, then test pits must be dug or soil borings drilled to verify the infiltration rate.

### **P.3 Test Pit/Boring Requirements for Infiltration Tests**

- (a) Excavate a test pit or drill a standard soil boring to a depth of 2 feet below the proposed facility bottom.
- (b) Determine depth to groundwater table (if within 2 feet of proposed bottom), and the estimated seasonally high groundwater table.
- (c) Determine Unified Soil Classification (USC) System textures at the proposed bottom and 4 feet below the bottom of the BMP.
- (d) Determine depth to bedrock (if within 2 feet of proposed bottom).
- (e) The soil description must include all soil horizons. If any of the soil horizons below the proposed bottom of the infiltration practice appear to be a confining layer, additional infiltration tests must be performed on this layer (or layers), following the procedure described below.
- (f) The location of the test pits or borings shall correspond to the BMP locations; test pit/soil boring stakes are to be left in the field for inspection purposes and shall be clearly labeled as such.

At least 1 test pit must be dug or encased soil boring drilled for each proposed infiltration-based BMP. For larger practices, additional test pits or soil borings are required for infiltration testing, as described in Table P.1 below.

**Table P.1 Number of Infiltration Tests Required per BMP**

Area of Practice (ft <sup>2</sup> )	Minimum Number of Test Pits/Soil Borings
< 1,000	1
1,000–1,999	2
2,000–9,999	3
≥ 10,000	Add 1 test pit/soil boring for each additional 5,000 ft <sup>2</sup> of BMP.

When more than one test pit or boring is necessary for a single BMP, the pit or boring locations must be equally spaced throughout the proposed area of the practice, as directed by the qualified professional. The reported infiltration rate for a BMP shall be the median or geometric mean of the observed results from the soil boring/test pit locations.

#### **P.4 Infiltration Testing Requirements**

The following tests are acceptable for use in determining soil infiltration rates. The geotechnical report shall include a detailed description of the test method and published source references:

- Well Permeameter Method (USBR 7300-89)
- Tube Permeameter Method (ASTM D 2434);
- Double-Ring Infiltrometer (ASTM D 3385);
- Other constant head permeability tests that utilize in-situ conditions and are accompanied by a recognized published source reference.

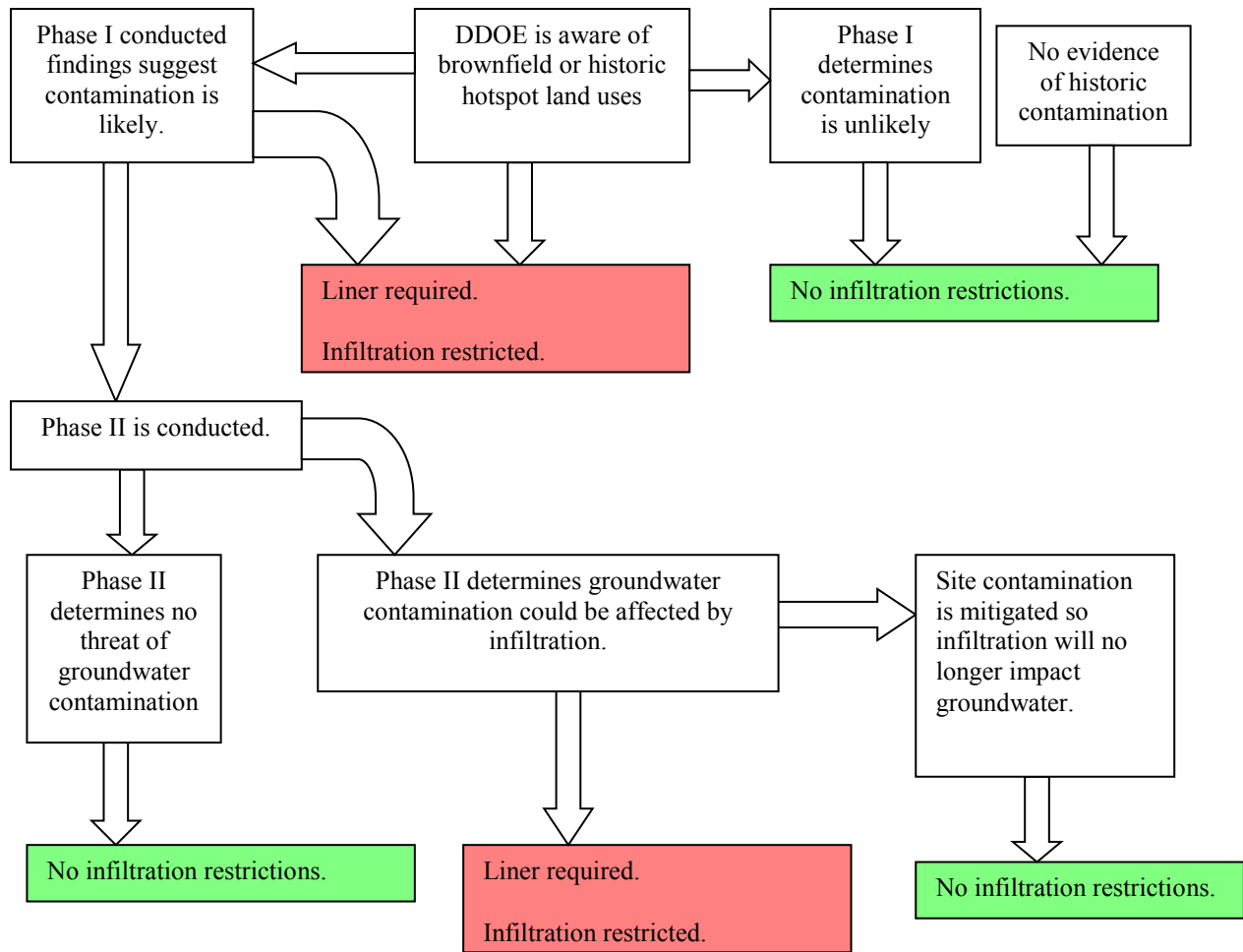
An infiltration test does not require ground water quality protection approval if

- the test is conducted to a depth of fifteen feet or less below the ground surface, and
- a Professional Engineer licensed in the District of Columbia certifies the infiltration rate and that the test was carried out in compliance with this guidance and accepted professional standards.

Note: If the infiltration testing procedure reveals smells or visual indications of soil or groundwater contamination then the boring or test hole must be filled in accordance with wellhead protection best practices, unless laboratory analysis determines groundwater or soil is not contaminated, as defined in the District of Columbia Brownfield Revitalization Act of 2000, as amended (D.C. Official Code §§ 8-631 et seq).

#### **P.5 Infiltration Restrictions**

If a Phase I Environmental Site Assessment determines that site contamination is likely, or if DDOE is aware of the presence of a brownfield or historic hotspot uses, such as current or previously existing leaking underground storage tanks (LUSTs), gas stations, or asphalt plants, an impermeable liner must be used for BMPs, and infiltration is restricted. If a Phase II Environmental Site Assessment is performed, and a qualified professional determines that the use of infiltration-based practices will not increase the likelihood of groundwater contamination, infiltration is not restricted. If there is no evidence of a history of contamination, impermeable liners are not required, and infiltration is not restricted.



# Appendix Q Stormwater Hotspots

## Q.1 Stormwater Hotspots

Stormwater hotspots are defined as commercial, industrial, institutional, municipal, or transport-related operations that produce higher levels of stormwater pollutants, and/or present a higher potential risk for spills, leaks or illicit discharges. The following operations are classified as stormwater hotspots operations in the District of Columbia:

H-1 Vehicle Maintenance and Repair

H-2 Vehicle Fueling

H-3 Vehicle Washing

H-4 Vehicle Storage

H-5 Loading and Unloading

H-6 Outdoor or Bulk Material Storage

If any of the above operations are expected to occur on the proposed site for which a Stormwater Management Plan (SWMP) is required, the Stormwater Hotspot Cover Sheet must be completed. Further, if a Construction General Permit Stormwater Pollution Prevention Plan (SWPPP<sub>CGP</sub>) was not required or the SWPPP<sub>CGP</sub> does not cover operational pollution prevention practices, then the *Stormwater Hotspot Checklist* must be submitted with the SWMP.

This appendix contains the following information:

- Stormwater Hotspot Cover Sheet
- Stormwater Hotspot Checklist
- Hotspot operation pollution prevention profile sheets for operations H-1 through H-6

## Q.2 Stormwater Hotspot Cover Sheet



**GOVERNMENT OF THE DISTRICT OF COLUMBIA**  
*District Department of the Environment*  
**1200 First Street NE, Fifth Floor, Washington DC 20002**

### ***Stormwater Hotspot Cover Sheet***

---

**Project Name:** \_\_\_\_\_

**Applicant Name:** \_\_\_\_\_

**Date:** \_\_\_\_\_

*Please indicate the appropriate hotspot operations for your project (check all that apply). If none apply check N/A.*

#### **Hotspot Operations:**

Vehicle Maintenance and Repair (H-1)

Vehicle Fueling (H-2)

Vehicle Washing (H-3)

Vehicle Storage (H-4)

Loading and Unloading (H-5)

Outdoor or Bulk Material Storage (H-6)

N/A

*If "N/A" is checked, please include this sheet only with plan submittal.*

*Otherwise, please indicate which of the following items are being included with the submittal of the Stormwater management Plan (SWMP). **Note: If a SWPPP<sub>CGP</sub> has not been completed or the SWPPP<sub>CGP</sub> does not cover operational pollution prevention practices, then the Stormwater Hotspot Checklist must be completed for the SWMP submittal to be considered complete.***

A completed Construction General Permit Stormwater Pollution Prevention Plan (SWPPP<sub>CGP</sub>)

A completed ***Stormwater Hotspot Checklist***

### Q.3 Stormwater Hotspot Checklist

#### *Stormwater Hotspot Checklist*

---

*Instructions: Complete the following site information:*

	<b>Requirement</b>	<i>Description</i>
<b>Site Description</b>	List the type of facility and facility address	
<b>Site Operations</b>	Describe the operations to be conducted on-site.	
<b>Receiving Waters</b>	Name(s) of the receiving water(s). If drains to a municipal storm sewer system, include ultimate receiving waters.	
<b>Site Materials</b>	Significant materials to be stored on-site (specify indoor or outdoor storage)	
<b>Stormwater Management Practices</b>	List the stormwater management practices being used to treat runoff from the site. Where appropriate, include description of design modifications appropriate for treatment of hotspot runoff (i.e .bioretention area with impermeable liner and underdrain)	
<b>Spill Prevention and Response</b>	Describe methods to prevent spills along with clean-up and notification procedures.	
<b>Employee Education Program</b>	Description of employee orientation and education program.	

*Instructions: Fill in the appropriate page number(s) from the site plans where the following site elements are clearly indicated.*

---

Appendix P Geotechnical Information Requirements for Underground BMPs

Site elements	Site Plan Sheet Number(s)	Check if N/A	Approved (for official use only)
Material loading and access areas			
Material storage and handling areas			
Cleaning and maintenance areas			
Vehicle or machinery storage areas			
Vehicle or machinery maintenance/service areas			
Treatment or disposal areas for significant materials			
Hazardous waste storage areas			
Areas of outdoor manufacturing			
Stormwater management calculations			
Drainage area outline for each stormwater inlet or structure			
Stormwater management practices			
Stormwater management maintenance inspection agreements			
Spill Prevention and Response Kits			
Facility inspection agreements for inspections of areas where potential spills of significant materials or industrial activities can impact stormwater			
<i>For official use only:</i>			
<b>Date of Submission:</b> _____ <b>Date Received:</b> _____	<b>Reviewed by:</b> _____ <b>Reviewed on:</b> _____	<b>Plan Accepted:</b> <b>Y / N</b>	



**Instructions:** Complete this table only if operation H-1 was checked on Page Q.2.

<b>H-1 Vehicle Maintenance and Repair Operations</b>			
<b>Description of Operation</b>			
<b>Requirement</b>	<b>Description of pollution prevention mechanism or BMP to be implemented</b>	<b>Site Plan Sheet Number(s)</b>	<b>Approved (for official use only)</b>
Provide locations for recycling collection of used antifreeze, oil, grease, oil filters, cleaning solutions, solvents, batteries, hydraulic and transmission fluids			
Cover all vehicle and equipment repair areas with a permanent roof or canopy.			
Connect outdoor vehicle storage areas to a separate stormwater collection system with an oil/grit separator or sand filter.			
Designate a specific location for outdoor maintenance activities that is designed to prevent stormwater pollution (paved, away from storm drains, and with stormwater containment measures)			
Stencil or mark storm drain inlets with "No Dumping, Drains to _____" message			

<i>For official use only:</i>		
<b>Date of Submission:</b> _____ <b>Date Received:</b> _____	<b>Reviewed by:</b> _____ <b>Reviewed on:</b> _____	<b>Plan Accepted: Y / N</b>

**Instructions:** Complete this table only if operation H-2 was checked on Page Q.2.

<b>H-2 Vehicle Fueling</b>			
Description of Operation			
Requirement	Description of pollution prevention mechanism or BMP to be implemented	Site Plan Sheet Number(s)	Approved (for official use only)
Cover fueling stations with a canopy or roof to prevent direct contact with rainfall			
Design fueling pads to prevent the run-on of stormwater and pretreat any runoff with an oil/grit separator or a sand filter			
Locate storm drain inlets away from the immediate vicinity of the fueling area			
Stencil or mark storm drain inlets with "No Dumping. Drains to _____" message			
Pave fueling stations with concrete rather than asphalt			

<i>For official use only:</i>		
<b>Date of Submission:</b> _____ <b>Date Received:</b> _____	<b>Reviewed by:</b> _____ <b>Reviewed on:</b> _____	<b>Plan Accepted: Y / N</b>

**Instructions:** Complete this table only if operation H-3 was checked on Page F.2.

<b>H-3 Vehicle Washing</b>			
Description of Operation			
Requirement	Description of pollution prevention mechanism or BMP to be implemented	Site Plan Sheet Number(s)	Approved (for official use only)
Include flow-restricted hose nozzles that automatically turn off when left unattended.			
a containment system for washing vehicles such that wash water does not flow into storm drain system.			
storm drain inlets with "No Dumping, Drains to _____" signs to deter disposal of wash water in the storm drain system			
Design facilities with designated areas for indoor vehicle washing where no other activities are performed (e.g., fluid changes or repair services)			

<i>For official use only:</i>		
<p><b>Date of Submission:</b> _____</p> <p><b>Date Received:</b> _____</p>	<p><b>Reviewed by:</b> _____</p> <p><b>Reviewed on:</b> _____</p>	<p><b>Plan Accepted: Y / N</b></p>

**Instructions:** Complete this table only if operation H-4 was checked on Page Q.2.

<b>H-4 Vehicle Storage</b>			
Description of Operation			
Requirement	Description of pollution prevention mechanism or BMP to be implemented	Site Plan Sheet Number(s)	Approved (for official use only)
Label storm drain inlets with "No Dumping, Drains to _____" message			
All stormwater runoff from the fleet storage area must receive pretreatment via an oil/grit separator or sand filter.			
Untreated stormwater from the fleet storage area may not be discharged off site.			
Connect outdoor vehicle storage areas to a separate stormwater collection system with an oil/grit separator or sand filter.			

<i>For official use only:</i>		
<b>Date of Submission:</b> _____ <b>Date Received:</b> _____	<b>Reviewed by:</b> _____ <b>Reviewed on:</b> _____	<b>Plan Accepted: Y / N</b>

**Instructions:** Complete this table only if operation H-5 was checked on Page Q.2.

<b>H-5 Loading and Unloading</b>			
Description of Operation			
Requirement	Description of pollution prevention mechanism or BMP to be implemented	Site Plan Sheet Number(s)	Approved (for official use only)
Design liquid storage areas with impervious surfaces and secondary containment			
Minimize stormwater run-on by covering storage areas with a permanent canopy or roof			
Slope containment areas to a drain with a positive control (lock, valve, or plug) that leads to the sanitary sewer (if permitted) or to a holding tank			
Provide permanent cover for building materials stored outside			
Direct runoff away from building material storage areas			
Install a high-level alarm on storage tanks to prevent overfilling			
<i>For official use only:</i>			
<b>Date of Submission:</b> _____ <b>Date Received:</b> _____	<b>Reviewed by:</b> _____ <b>Reviewed on:</b> _____		<b>Plan Accepted: Y / N</b>

**Instructions:** Complete this table only if operation H-6 was checked on Page Q.2.

<b>H-6 Outdoor or Bulk Material Storage</b>			
Description of Operation	(include methods of storage, usage, treatment, and disposal).		
Requirement	Description of pollution prevention mechanism or BMP to be implemented	Site Plan Sheet Number(s)	Approved (for official use only)
Grade the designated loading/unloading to prevent run-on or pooling of stormwater			
Cover the loading/unloading areas with a permanent canopy or roof			
Install an automatic shutoff valve to interrupt flow in the event of a liquid spill			
Install a high-level alarm on storage tanks to prevent overfilling			
Pave the loading/unloading area with concrete rather than asphalt			
Position roof downspouts to direct stormwater away from loading/unloading areas			

<i>For official use only:</i>		
<b>Date of Submission:</b> _____ <b>Date Received:</b> _____	<b>Reviewed by:</b> _____ <b>Reviewed on:</b> _____	<b>Plan Accepted: Y / N</b>

#### **Q.4 Hotspot Operation Pollution Prevention Profile Sheets**

The following profile sheets include:

H-1 Vehicle Maintenance and Repair


H-2 Vehicle Fueling

H-3 Vehicle Washing

H-4 Vehicle Storage

H-5 Loading and Unloading

H-6 Outdoor or Bulk Material Storage

<b>H-1</b>	<b>Hotspot Source Area: Vehicles</b>	
	<b>VEHICLE MAINTENANCE AND REPAIR</b>	

**Description**

Vehicle maintenance and repair operations can exert a significant impact on water quality by generating toxins such as solvents, waste oil, antifreeze, and other fluids. Often, vehicles that are wrecked or awaiting repair can be a stormwater hotspot if leaking fluids are exposed to stormwater runoff (Figure 1). Vehicle maintenance and repair can generate oil and grease, trace metals, hydrocarbons, and other toxic



**Figure 1: Junkyard and Potential Source of Stormwater Pollution**

organic compounds. Table 1 summarizes a series of simple pollution prevention techniques for vehicle maintenance and repair operations that can prevent stormwater contamination. You are encouraged to consult the Resources section of this sheet to get a more comprehensive review of pollution prevention practices for vehicle maintenance and repair operations.

**Application**

Pollution prevention practices should be applied to any facility that maintains or repairs vehicles in a subwatershed. Examples include car dealerships, body shops, service stations, quick lubes, school bus depots, trucking companies, and fleet maintenance operations at larger industrial, institutional, municipal or transport-related operations. Repair facilities are often clustered together, and are a major priority for subwatershed pollution prevention.

**Table 1: Pollution Prevention Practices for Vehicle Maintenance and Repair Activities**

- Avoid hosing down work or fueling areas
- Clean all spills immediately using dry cleaning techniques
- Collect used antifreeze, oil, grease, oil filters, cleaning solutions, solvents, batteries, hydraulic and transmission fluids and recycle with appropriate agencies
- Conduct all vehicle and equipment repairs indoors or under a cover (if done outdoors)
- Connect outdoor vehicle storage areas to a separate stormwater collection system with an oil/grit separator that discharges to a dead holding tank, the sanitary sewer or a stormwater treatment practice
- Designate a specific location for outdoor maintenance activities that is designed to prevent stormwater pollution (paved, away from storm drains, and with stormwater containment measures)
- Inspect the condition of all vehicles and equipment stored outdoors frequently
- Use a tarp, ground cloth, or drip pans beneath vehicles or equipment being repaired outdoors to capture all spills and drips
- Seal service bay concrete floors with an impervious material so cleanup can be done without using solvents. Do not wash service bays to outdoor storm drains
- Store cracked batteries in a covered secondary containment area until they can be disposed of properly
- Wash parts in a self-contained solvent sink rather than outdoors



### **Primary Training Targets**

Owners, fleet operation managers, service managers, maintenance supervisors, mechanics and other employees are key targets for training.

### **Feasibility**

Pollution prevention techniques for vehicle repair facilities broadly apply to all regions and climates. These techniques generally rely on changes to basic operating procedures, after an initial inspection of facility operations. The inspection relies on a standard operations checklist that can be completed in a few hours.

### **Implementation Considerations**

Employee training is essential to successfully implement vehicle repair pollution prevention practices. The connection between the storm drain system and local streams should be emphasized so that employees understand why any fluids need to be properly disposed of. It is also important to understand the demographics of the work force; in some communities, it may require a multilingual education program.

*Cost* - Employee training is generally inexpensive, since training can be done using posters, pamphlets, or videos. Structural practices can vary based on what equipment is required. For instance, solvent sinks to clean parts can cost from \$1,500 to \$15,000, while spray cabinets may cost more than \$50,000. In addition, proper recycling/disposal of used or spilled fluids usually requires outside contractors that may increase costs.

### **Resources**

*Stormwater Management Manual for Western Washington: Volume IV -- Source Control BMPs.*  
<http://www.ecy.wa.gov/biblio/9914.html>

*California Stormwater Quality Association. 2003 California Stormwater BMP*

*Handbook: Industrial and Commercial.*  
<http://www.cabmphandbooks.com/>

*Coordinating Committee For Automotive Repair (CCAR) Source: US EPA CCAR-GreenLink®, the National Automotive Environmental Compliance Assistance Center CCAR-GreenLink® Virtual Shop*  
<http://www.ccar-greenlink.org/>

*Auto Body Shops Pollution Prevention Guide. Peaks to Prairies Pollution Prevention Information Center.*  
<http://peakstoprairies.org/p2bande/autobody/abguide/index.cfm>


*Massachusetts Office of Technical Assistance (OTA). Crash Course for Compliance and Pollution Prevention Toolbox*  
<http://www.mass.gov/eea/grants-and-tech-assistance/education-and-training/education-and-outreach/ota-publications/guidance-docs/crash-course.html>

*Model Urban Runoff Program: A How-To Guide for Developing Urban Runoff Programs for Small Municipalities.*  
[http://www.swrcb.ca.gov/water\\_issues/programs/stormwater/murp.shtml](http://www.swrcb.ca.gov/water_issues/programs/stormwater/murp.shtml)

US EPA. Facility Regulatory Tour: Vehicle Maintenance.  
<https://www.fedcenter.gov/assistance/facilitytour/vehicle/>

City of Santa Cruz. Best Management Practices for Vehicle Service Facilities (in English and Spanish).  
<http://www.cityofsantacruz.com/Modules/ShowDocument.aspx?documentid=5989>

*City of Los Angeles Bilingual Poster of BMPs for Auto Repair Industry*  
[http://www.lastormwater.org/wp-content/files\\_mf/bmp\\_auto\\_poster\\_8.5x14.pdf](http://www.lastormwater.org/wp-content/files_mf/bmp_auto_poster_8.5x14.pdf)

<b>H-2</b>	<b>Hotspot Source Area: Vehicles</b>	
	VEHICLE FUELING	

**Description**

Spills at vehicle fueling operations have the potential to directly contribute oil, grease, and gasoline to stormwater, and can be a significant source of lead, copper and zinc, and petroleum hydrocarbons. Delivery of pollutants to the storm drain can be sharply reduced by well-designed fueling areas and improved operational procedures. The risk of spills depends on whether the fueling area is covered and has secondary containment. The type, condition, and exposure of the fueling surface can also be important. Table 1 describes common pollution prevention practices for fueling operations.

these practices also apply to temporary above-ground fueling areas for construction and earthmoving equipment. Many fueling areas are usually present in urban subwatersheds, and they tend to be clustered along commercial and highway corridors. These hotspots are often a priority for subwatershed source control.

**Application**

These practices can be applied to any facility that dispenses fuel. Examples include retail gas stations, bus depots, marinas, and fleet maintenance operations (Figure 1). In addition,



**Figure 1: Covered Retail Gas Operation Without Containment for Potential**

**Table 1: Pollution Prevention Practices For Fueling Operation Areas**

- Maintain an updated spill prevention and response plan on premises of all fueling facilities (see Profile Sheet H-7)
- Cover fueling stations with a canopy or roof to prevent direct contact with rainfall
- Design fueling pads for large mobile equipment to prevent the run-on of stormwater and collect any runoff in a dead-end sump
- Retrofit underground storage tanks with spill containment and overflow prevention systems
- Keep suitable cleanup materials on the premises to promptly clean up spills
- Install slotted inlets along the perimeter of the —downhill” side of fueling stations to collect fluids and connect the drain to a waste tank or stormwater treatment practice. The collection system should have a shutoff valve to contain a large fuel spill event
- Locate storm drain inlets away from the immediate vicinity of the fueling area
- Clean fuel-dispensing areas with dry cleanup methods. Never wash down areas before dry clean up has been done. Ensure that wash water is collected and disposed of in the sanitary sewer system or approved stormwater treatment practice
- Pave fueling stations with concrete rather than asphalt
- Protect above ground fuel tanks using a containment berm with an impervious floor of Portland cement. The containment berm should have enough capacity to contain 110 percent of the total tank volume
- Use fuel-dispensing nozzles with automatic shutoffs, if allowed
- Consider installing a perimeter sand filter to capture and treat any runoff produced by the station

### **Primary Training Targets**

Training efforts should be targeted to owners, operators, attendants, and petroleum wholesalers.

### **Feasibility**

Vehicle fueling pollution prevention practices apply to all geographic and climatic regions. The practices are relatively low-cost, except for structural measures that are installed during new construction or station remodeling.

### **Implementation Considerations**

*Fueling Area Covers* - Fueling areas can be covered by installing an overhanging roof or canopy. Covers prevent exposure to rainfall and are a desirable amenity for retail fueling station customers. The area of the fueling cover should exceed the area where fuel is dispensed. All downspouts draining the cover or roof should be routed to prevent discharge across the fueling area. If large equipment makes it difficult to install covers or roofs, fueling islands should be designed to prevent stormwater run-on through grading, and any runoff from the fueling area should be directed to a dead-end sump.

*Surfaces* - Fuel dispensing areas should be paved with concrete; the use of asphalt should be avoided, unless the surface is sealed with an impervious sealant. Concrete pads used in fuel dispensing areas should extend to the full length that the hose and nozzle assembly can be pulled, plus an additional foot.

*Grading* - Fuel dispensing areas should be graded with a slope that prevents ponding, and separated from the rest of the site by berms, dikes or other grade breaks that prevent run-on of urban runoff. The recommended grade for fuel dispensing areas is 2–4 percent (CSWQTF, 1997).

*Cost* - Costs to implement pollution prevention practices at fueling stations will vary, with many of the costs coming upfront during the design of a new fueling facility. Once a facility has implemented the, ongoing maintenance costs should be low.

### **Resources**

*Best Management Practice Guide – Retail Gasoline Outlets*. Prepared by Retail Gasoline Outlet Work Group.

[http://www.waterboards.ca.gov/rwqcb4/water\\_issues/programs/stormwater/municipal/los\\_angeles\\_ms4/tentative/rgo%20bmp%20guide\\_03-97\\_.pdf](http://www.waterboards.ca.gov/rwqcb4/water_issues/programs/stormwater/municipal/los_angeles_ms4/tentative/rgo%20bmp%20guide_03-97_.pdf)

*Stormwater Management Manual for Western Washington: Volume IV -- Source Control BMPs*.

<http://www.ecy.wa.gov/biblio/9914.html>

*California Stormwater Quality Association. 2003 California Stormwater BMP Handbook: New Development and Redevelopment*.

<http://www.cabmphandbooks.com/>

*City of Los Angeles, CA Best Management Practices for Gas Stations*

[http://www.lacitysan.org/watershed\\_protection/pdfs/gasstation.pdf](http://www.lacitysan.org/watershed_protection/pdfs/gasstation.pdf)

*City of Dana Point Tips for the Automotive Industry*

<http://www.danapoint.org/Modules/ShowDocument.aspx?documentid=3309>

*Alachua County, FL Best Management Practices for Controlling Runoff from Gas Stations*

<http://www.alachuacounty.us/Depts/EPD/Documents/WaterResources/Gas%20Stations.pdf>

*California Stormwater Regional Control Board Retail Gasoline Outlets: New Development Design Standards For Mitigation Of Stormwater Impacts*

[http://www.waterboards.ca.gov/rwqcb4/water\\_issues/programs/stormwater/municipal/los\\_angeles\\_ms4/tentative/rgopaper.pdf](http://www.waterboards.ca.gov/rwqcb4/water_issues/programs/stormwater/municipal/los_angeles_ms4/tentative/rgopaper.pdf)

[http://www.waterboards.ca.gov/rwqcb4/water\\_issues/programs/stormwater/municipal/los\\_angeles\\_ms4/tentative/rgopapersupplement\\_12-01\\_.pdf](http://www.waterboards.ca.gov/rwqcb4/water_issues/programs/stormwater/municipal/los_angeles_ms4/tentative/rgopapersupplement_12-01_.pdf)


*Canadian Petroleum Products Institute Best Management Practices Stormwater Runoff from Petroleum Facilities*

<http://canadianfuels.ca/userfiles/file/CPPI%20-%20BMP%20Stormwater%20runoff%20-%20March-04.pdf>

*City of Monterey (CA). Posters of Gas Station BMPs.*

*Pinole County, CA Typical Stormwater Violations Observed in Auto Facilities and Recommended Best Management Practices (BMPs)*

<http://www.ci.pinole.ca.us/publicworks/downloads/AutoStormwater.pdf>

<b>H-3</b>	<b>Hotspot Source Area: Vehicles</b>	
	<b>VEHICLE WASHING</b>	

**Description**

Vehicle washing pollution prevention practices apply to many commercial, industrial, institutional, municipal and transport-related operations. Vehicle wash water may contain sediments, phosphorus, metals, oil and grease, and other pollutants that can degrade water quality. When vehicles are washed on impervious surfaces such as parking lots or industrial areas, dirty wash water can contaminate stormwater that ends up in streams.

**Application**

Improved washing practices can be used at any facility that routinely washes vehicles. Examples include commercial car washes, bus depots, car dealerships, rental car companies, trucking companies, and fleet operations. In addition, washing dump trucks and other construction equipment can be a problem. Washing operations tend to be unevenly distributed within urban subwatersheds. Vehicle washing also occurs in neighborhoods, and techniques to keep wash water out of the storm drain system are discussed in the car washing profile sheet (N-11). Table 1 reviews some of the pollution prevention techniques available for hotspot vehicle washing operations.

**Primary Training Targets**

Owners, fleet managers, and employees of operations that include car washes are the primary training target.

**Feasibility**

Vehicle washing practices can be applied to all regions and climates. Vehicle washing tends to occur more frequently in summer

months and in drier regions of the country. Sound vehicle washing practices are not always used at many sites because operators are reluctant to change traditional cleaning methods. In addition, the cost of specialized equipment to manage high volumes of wash water can be too expensive for small businesses.

Improved vehicle washing practices are relatively simple to implement and are very effective at preventing stormwater contamination. Training is essential to get owners and employees to adopt these practices, and should be designed to overcome cultural and social barriers to improved washing practices.

**Table 1: Pollution Prevention Practices for Vehicle Washing**

- Wash vehicles at indoor car washes that recycle, treat or convey wash water to the sanitary sewer system
- Use biodegradable, phosphate-free, water-based soaps
- Use flow-restricted hose nozzles that automatically turn off when left unattended
- Wash vehicles on a permeable surface or a washpad that has a containment system
- Prohibit discharge of wash water into the storm drain system or ground by using temporary berms, storm drain covers, drain plugs or other containment system
- Label storm drains with “No Dumping” signs to deter disposal of wash water in the storm drain system
- Pressure and steam clean off-site to avoid runoff with high pollutant concentrations
- Obtain permission from sewage treatment facilities to discharge to the sanitary sewer

### Implementation Considerations

The ideal practice is to wash all vehicles at commercial car washes or indoor facilities that are specially designed for washing operations. Table 2 offers some tips for indoor car wash sites. When washing operations are conducted outside, a designated wash area should have the following characteristics:

- Paved with an impervious surface, such as Portland cement concrete
- Bermed to contain wash water
- Sloped so that wash water is collected and discharged to the sanitary sewer system, holding tank or dead-end sump
- Operated by trained workers to confine washing operations to the designated wash area

**Table 2: Tips for Indoor Car Wash Sites** *(Adapted from U.S. EPA, 2003)*

- Facilities should have designated areas for indoor vehicle washing where no other activities are performed (e.g., fluid changes or repair services)
- Indoor vehicle wash areas should have floor drains that receive only vehicle washing wastewater (not floor washdown or spill removal wash waters) and be connected to a holding tank with a gravity discharge pipe, to a sump that pumps to a holding tank, or to an oil/grit separator that discharges to a municipal sanitary sewer
- The floor of indoor vehicle wash bays should be completely bermed to collect wash water
- Aromatic and chlorinated hydrocarbon solvents should be eliminated from vehicle-washing operations
- Vehicle-washing operations should use vehicle rinsewater to create new wash water through the use of recycling systems that filter and remove grit.

Outdoor vehicle washing facilities should use pressurized hoses without detergents to remove most dirt and grime. If detergents are used, they should be phosphate-free to reduce nutrient loading. If acids, bases, metal brighteners, or degreasing agents are used, wash water should be discharged to a treatment facility, sanitary sewer, or a sump. In addition, waters from the pressure washing of engines and vehicle undercarriages must be disposed of using the same options.

Discharge to pervious areas may be an option for washing operations that generate small amounts of relatively clean wash water (water only - no soaps, no steam cleaning). The clean wash water should be directed as sheet flow across a vegetated area to infiltrate or evaporate before it enters the storm drain system. This option should be exercised with caution, especially in environmentally sensitive areas or protected groundwater recharge areas.

The best way to avoid stormwater contamination during washing operations is to drain the wash water to the sanitary sewer system. Operations that produce high volumes of wash water should consider installing systems that connect to the sewer. Other options for large and small operations include containment units to capture the wash water prior to transport away for proper disposal (Figure 1). If vehicles must be washed on an impervious surface, a storm drain filter should be used to capture solid contaminants.

*Cost* - The cost of using vehicle-washing practices can vary greatly and depends on the size of the operation (Table 3). The cost of constructing a commercial grade system connected to the sanitary sewer can exceed \$100,000. Disposal fees and frequency of washing can also influence the cost. Training costs can be minimized by using



**Figure 1: Containment System Preventing Wash Water from Entering the Storm Drain**

educational materials available from local governments, professional associations or EPA’s National Compliance Assistance Centers (<http://www.assistancecenters.net/>). Temporary, portable containment systems can be shared by several companies that cannot afford specialized equipment independently.

<b>Table 3: Sample Equipment Costs for Vehicle Washing Practices</b>	
<b>Item</b>	<b>Cost</b>
Bubble Buster	\$2,000–\$2,500*
Catch basin insert	\$65*
Containment mat	\$480–\$5,840**
Storm drain cover (24-in. drain)	\$120 **
Water dike/ berm (20 ft)	\$100.00 **
Pump	\$75–\$3,000**
Wastewater storage container	\$50–\$1,000+**
<i>Source: *U.S. EPA, 1992 **Robinson, 2003</i>	

## Resources

*EPA FedSite Facility Regulatory Tour:*

<https://www.fedcenter.gov/assistance/facilitytour/vehicle/washing/>

*Alachua County BMP for Outdoor Car Washing.*

<http://www.alachuacounty.us/Depts/EPD/WaterResources/StormwaterPollutionAndSolutions/Reducing%20Stormwater%20Pollution%20Documents/Carwash%20BMP.pdf>

*Kitsap County Sound Car Wash Program.*

<http://www.kitsapgov.com/sswm/carwash.htm>.

*Washington Department of Ecology. 1995. Vehicle and Equipment Wash Water Discharges: Best Management Practices Manual. Olympia, Washington.*


<http://www.ecy.wa.gov/pubs/95056.pdf>

*U.S. Environmental Protection Agency. Pollution Prevention/Good Housekeeping for Municipal Operations.*

[http://cfpub2.epa.gov/npdes/stormwater/menuoofbmps/poll\\_18.cfm](http://cfpub2.epa.gov/npdes/stormwater/menuoofbmps/poll_18.cfm)

*California Stormwater Quality Association. 2003 California Stormwater BMP*

*Handbook: Industrial and Commercial.*  
<http://www.cabmphandbooks.com/>

<b>H-4</b>	<b>Hotspot Source Area: Vehicles</b>	
	VEHICLE STORAGE	

**Description**

Parking lots and vehicle storage areas can introduce sediment, metals, oil and grease, and trash into stormwater runoff. Simple pavement sweeping, litter control, and stormwater treatment practices can minimize pollutant export from these hotspots. Table 1 provides a list of simple pollution prevention practices intended to prevent or reduce the discharge of pollutants from parking and vehicle storage areas.

or wrecked vehicles) should be targeted first. This practice is also closely related to parking lot maintenance source controls, which are discussed in greater detail in profile sheet H-11.

**Primary Training Targets**

Owners, fleet operation managers, and property managers that maintain parking lots are key training targets.

**Application**

Pollution prevention practices can be used at larger parking lots located within a subwatershed. Examples include regional malls, stadium lots, big box retail, airport parking, car dealerships, rental car companies, trucking companies, and fleet operations (Figure 1). The largest, most heavily used parking lots with vehicles in the poorest condition (e.g., older cars



**Figure 1: Retail Parking Lot**

<b>Table 1: Pollution Prevention Practices for Parking Lot and Vehicle Storage Areas</b>
<p><i>Parking Lots</i></p> <ul style="list-style-type: none"> <li>▪ Post signs to control litter and prevent patrons from changing automobile fluids in the parking lot (e.g., changing oil, adding transmission fluid, etc.)</li> <li>▪ Pick up litter daily and provide trash receptacles to discourage littering</li> <li>▪ Stencil or mark storm drain inlets with "No Dumping, Drains to _____" message</li> <li>▪ Direct runoff to bioretention areas, vegetated swales, or sand filters</li> <li>▪ Design landscape islands in parking areas to function as bioretention areas</li> <li>▪ Disconnect rooftop drains that discharge to paved surfaces</li> <li>▪ Use permeable pavement options for spillover parking (Profile sheet OS-11 in Manual 3)</li> <li>▪ Inspect catch basins twice a year and remove accumulated sediments, as needed</li> <li>▪ Vacuum or sweep large parking lots on a monthly basis, or more frequently</li> <li>▪ Install parking lot retrofits such as bioretention, swales, infiltration trenches, and stormwater filters (Profile sheets OS-7 through OS-10 in Manual 3)</li> </ul>



**Table 1: Pollution Prevention Practices for Parking Lot and Vehicle Storage Areas**

<p><i>Vehicle Storage Areas</i></p> <ul style="list-style-type: none"> <li>▪ Do not store wrecked vehicles on lots unless runoff containment and treatment are provided</li> <li>▪ Use drip pans or other spill containment measures for vehicles that will be parked for extended periods of time</li> <li>▪ Use absorbent material to clean up automotive fluids from parking lots</li> </ul>
---

**Feasibility**

Sweeping can be employed for parking lots that empty out on a regular basis. Mechanical sweepers can be used to remove small quantities of solids. Vacuum sweepers should be used on larger parking lot storage areas, since they are superior in picking up deposited pollutants (see Manual 9). Constraints for sweeping large parking lots include high annual costs, difficulty in controlling parking, and the inability of current sweeper technology to remove oil and grease. Proper disposal of swept materials might also represent a limitation.

**Implementation Considerations**

The design of parking lots and vehicle storage areas can greatly influence the ability to treat stormwater runoff. Many parking areas are landscaped with small vegetative areas between parking rows for aesthetic reasons or to create a visual pattern for traffic flow. These landscaped areas can be modified to provide stormwater treatment in the form of bioretention (Figure 2).



**Figure 2: Parking Lot Island Turned Bioretention**


Catch basin cleanouts are also an important practice in parking areas. Catch basins within the parking lot should be inspected at least twice a year and cleaned as necessary. Cleanouts can be done manually or by vacuum truck. The cleanout method selected depends on the number and size of the inlets present (see Manual 9).

Most communities have contractors that can be hired to clean out catch basins and vacuum sweep lots. Mechanical sweeping services are available, although the cost to purchase a new sweeper can exceed \$200,000. Employee training regarding spill prevention for parking areas is generally low-cost and requires limited staff time.

**Resources**

*California Stormwater Quality Association. 2003 California Stormwater BMP Handbook: Industrial and Commercial*  
<http://www.cabmphandbooks.com/>

*Stormwater Management Manual for Western Washington: Volume IV -- Source Control BMPs. WA Dept. of Ecology*  
<http://www.ecy.wa.gov/biblio/9914.html>

<b>H-5</b>	<b>Hotspot Source Area: Outdoor Materials</b>	
	LOADING AND UNLOADING	

**Description**

Outdoor loading and unloading normally takes place on docks or terminals at many commercial, industrial, institutional, and municipal operations. Materials spilled or leaked during this process can either be carried away in stormwater runoff or washed off when the area is cleaned. As a result, many different pollutants can be introduced into the storm drain system, including sediment, nutrients, trash, organic material, trace metals, and an assortment of other pollutants. A number of simple and effective pollution prevention practices can be used at loading/unloading areas to prevent runoff contamination, as shown in Table 1.

**Application**

While nearly every commercial, industrial, institutional, municipal and transport-related site has a location where materials or products are shipped or received, the risk of

stormwater pollution is greatest for operations that transfer high volumes of material or liquids, or unload potentially hazardous materials. Some notable examples to look for in a subwatershed include distribution centers, grocery stores, building supply outlets, lawn and garden centers, petroleum wholesalers, warehouses, landfills, ports, solid waste facilities, and maintenance depots (Figure 1). Attention should also be paid to industrial operations that process bulk materials and any operations regulated under industrial stormwater NPDES permits.

**Primary Training Targets**

Owners, site managers, facility engineers, supervisors, and employees of operations with loading/unloading facilities are the primary training target.

**Table 1: Pollution Prevention Practices for Loading and Unloading Areas**

<ul style="list-style-type: none"> <li>▪ Avoid loading/unloading materials in the rain</li> <li>▪ Close adjacent storm drains during loading/unloading operations</li> <li>▪ Surround the loading/unloading area with berms or grading to prevent run-on or pooling of stormwater. If possible, cover the area with a canopy or roof</li> <li>▪ Ensure that a trained employee is always present to handle and cleanup spills</li> <li>▪ Inspect the integrity of all containers before loading/unloading</li> <li>▪ Inspect equipment such as valves, pumps, flanges, and connections regularly for leaks, and repair as needed</li> <li>▪ Install an automatic shutoff valve to interrupt flow in the event of a catastrophic liquid spill</li> <li>▪ Install a high-level alarm on storage tanks to prevent overfilling</li> <li>▪ Pave the loading/unloading area with concrete rather than asphalt</li> <li>▪ Place drip pans or other temporary containment devices at locations where leaks or spills may occur, and always use pans when making and breaking connections</li> <li>▪ Position roof downspouts to direct stormwater away from loading/unloading areas and into bioretention areas</li> <li>▪ Prepare and implement an Emergency Spill Cleanup Plan for the facility (see Profile Sheet H-7)</li> <li>▪ Sweep loading/unloading area surfaces frequently to remove material that could otherwise be washed off by stormwater</li> <li>▪ Train all employees, especially fork lift operators, on basic pollution prevention practices and post signs</li> <li>▪ Use seals, overhangs, or door skirts on docks and terminals to prevent contact with rainwater</li> </ul>
--

### **Feasibility**

Loading/unloading pollution prevention practices can be applied in all geographic and climatic regions, and work most effectively at preventing sediment, nutrients, toxic materials, and oil from coming into contact with stormwater runoff or runoff. Few impediments exist to using this practice, except for the cost to retrofit existing loading and unloading areas with covers or secondary containment.

### **Implementation Considerations**

Loading/unloading pollution prevention practices should be integrated into the overall stormwater pollution prevention plan for a facility. Employee training should focus on proper techniques to transfer materials, using informational signs at loading docks and material handling sites and during routine safety meetings.

*Cost* - Costs to implement loading/unloading pollution prevention practices consist of one-time construction costs to retrofit new or existing loading areas, but annual maintenance costs are relatively low thereafter. Exceptions include industries that elect to use expensive air pressure or vacuum systems for loading/unloading facilities, which can also be expensive to



**Figure 1: Loading/Unloading Area of Warehouse**

maintain (U.S. EPA, 1992). Ongoing costs include employee training and periodic monitoring of loading/unloading activities.

### **Resources**

*California Stormwater Quality Association. 2003 California Stormwater BMP Handbook: Industrial and Commercial.*  
<http://www.cabmphandbooks.com/>


*Stormwater Management Manual for Western Washington: Volume IV -- Source Control BMPs. WA Dept. of Ecology 99-14*  
<http://www.ecy.wa.gov/biblio/9914.html>

*Ventura County Flood Control District Clean Business Program Fact Sheet*

<http://www.vcstormwater.org/index.php/clean-business-fact-sheets>

*Business Best Management Practices Stormwater Bmp #3 - Shipping/Receiving/Loading Docks*

*City of Los Angeles, CA Reference Guide For Stormwater Best Management Practices*  
[http://www.lacitysan.org/watershed\\_protection/pdfs/bmp\\_refguide.pdf](http://www.lacitysan.org/watershed_protection/pdfs/bmp_refguide.pdf)

<b>H-6</b>	<b>Hotspot Source Area: Outdoor Materials</b>	
	OUTDOOR STORAGE	

**Description**

Protecting outdoor storage areas is a simple and effective pollution prevention practice for many commercial, industrial, institutional, municipal, and transport-related operations. The underlying concept is to prevent runoff contamination by avoiding contact between outdoor materials and rainfall (or runoff). Unprotected outdoor storage areas can generate a wide range of stormwater pollutants, such as sediment, nutrients, toxic materials, and oil and grease (Figure 1).

Materials can be protected by installing covers, secondary containment, and other structures to prevent accidental release. Outdoor storage areas can be protected on a temporary basis (tarps or plastic sheeting) or permanently through structural containment measures (such as roofs, buildings, or concrete berms). Table 1 summarizes pollution prevention practices available for outdoor storage areas.

**Application**

Many businesses store materials or products outdoors. The risk of stormwater pollution is greatest for operations that store large quantities of liquids or bulk materials at sites



**Figure 1: Mulch Stored Outdoors at a Garden Center**

that are connected to the storm drain system. Several notable operations include nurseries and garden centers, boat building/repair, auto recyclers/body shops, building supply outlets, landfills, ports, recycling centers, solid waste and composting facilities, highway maintenance depots, and power plants. Attention should also be paid to industrial operations that process bulk materials, which are often regulated under industrial stormwater NPDES permits.

**Primary Training Targets**

Owners, site managers, facility engineers, supervisors, and employees of operations with loading/unloading facilities are the primary training target.

**Feasibility**

Outdoor storage protection can be widely applied in all regions and climate zones, and requires routine monitoring by employees. Most operations have used covering as the major practice to handle outdoor storage protection (U.S. EPA, 1999). The strategy is to design and maintain outdoor material storage areas so that they:

- Reduce exposure to stormwater and prevent runoff
- Use secondary containment to capture spills
- Can be regularly inspected
- Have an adequate spill response plan and cleanup equipment

**Table 1: Pollution Prevention Practices for Protecting Outdoor Storage Areas**

- Emphasize employee education regarding storage area maintenance
- Keep an up-to-date inventory of materials stored outdoors, and try to minimize them
- Store liquids in designated areas on an impervious surface with secondary containment
- Inspect outdoor storage containers regularly to ensure that they are in good condition
- Minimize stormwater run-on by enclosing storage areas or building a berm around them
- Slope containment areas to a drain with a positive control (lock, valve, or plug) that leads to the sanitary sewer (if permitted) or to a holding tank
- Schedule regular pumping of holding tanks containing stormwater collected from secondary containment areas

### Implementation Considerations

**Covers** - The use of impermeable covers is an effective pollution prevention practice for non-hazardous materials. Covers can be as simple as plastic sheeting or tarps, or more elaborate roofs and canopies. Site layout, available space, affordability, and compatibility with the covered material all dictate the type of cover needed for a site. In addition, the cover should be compatible with local fire and building codes and OSHA workplace safety standards. Care should be taken to ensure that the cover fully protects the storage site and is firmly anchored into place.

**Secondary Containment** - Secondary containment is designed to contain possible spills of liquids and prevent stormwater run-on from entering outdoor storage areas. Secondary containment structures vary in design, ranging from berms and drum holding areas to specially designed solvent storage rooms (Figure 2).

Secondary containment can be constructed from a variety of materials, such as concrete curbs, earthen berms, plastic tubs, or fiberglass or metal containers. The type of material used depends on the substance contained and its resistance to weathering. In general, secondary containment areas should be sized to hold 110 percent of the volume of the storage tank or container unless other containment sizing regulations apply (e.g., fire codes).



**Figure 2: Secondary Containment of Storage Drums Behind a Car Repair Shop**

If secondary containment areas are uncovered, any water that accumulates must be collected in a sanitary sewer, a stormwater treatment system, or a licensed disposal facility. Water quality monitoring may be needed to determine whether the water is contaminated and dictate the method of disposal. If the stormwater is clean, or an on-site stormwater treatment practice is used, a valve should be installed in the containment dike so that excess stormwater can be drained out of the storage area and directed either to the storm drain (if clean) or into the stormwater treatment system (if contaminated). The valve should always be kept closed except when stormwater is drained, so that any spills that occur can be effectively contained. Local sewer authorities may not allow discharges from a large containment area into the sewer system, and permission must be obtained

**Table 2: Sample Equipment Costs for Outdoor Storage Protection**

Storage Protection Device	Cost
Concrete Slab (6")	\$3.50 to \$5.00 per ft <sup>2</sup>
Containment Pallets	\$50 to \$350 based on size and # of barrels to be stored
Storage buildings	\$6 to \$11 per ft <sup>2</sup>
Tarps & Canopies	\$25 to \$500 depending on size of area to cover
<i>Sources: Costs were derived from a review of Ferguson et al., 1997 and numerous websites that handle proprietary spill control or hazardous material control products</i>	

prior to discharge. If discharges to the sanitary sewer system are prohibited, containment should be provided, such as a holding tank that is regularly pumped out.

Employee training on outdoor storage pollution prevention should focus on the activities and site areas with the potential to pollute stormwater and the proper techniques to manage material storage areas to prevent runoff contamination. Training can be conducted through safety meetings and the posting of on-site informational signs. Employees should also know the on-site person who is trained in spill response.

*Cost* - Many storage protection practices are relatively inexpensive to install (Table 2). Actual costs depend on the size of the storage area and the nature of the pollution prevention practices. Other factors are whether practices are temporary or permanent and the type of materials used for covers and containment. Employee training can be done in connection with other safety training to reduce program costs. Training costs can also be reduced by using existing educational materials from local governments, professional associations or

from EPA's National Compliance Assistance Centers (<http://www.assistancecenters.net>).

### Resources

*California Stormwater Quality Association. 2003 California Stormwater BMP Handbook: Industrial and Commercial.*  
<http://www.cabmphandbooks.com/>

*Rouge River National Wet Weather Demonstration Project.* Wayne County, MI.  
<http://www.rougeriver.com/proddata/catalog7ad4.html?category=overview#PI-PAPER-01.00>

*Storm Water Management Fact Sheet: Coverings.* USEPA, Office of Water,  
[http://water.epa.gov/scitech/wastetech/upload/2002\\_06\\_28\\_mtb\\_covs.pdf](http://water.epa.gov/scitech/wastetech/upload/2002_06_28_mtb_covs.pdf)

*EPA Office of Wastewater Management Storm Water Management Fact Sheet: Coverings*  
<http://www.epa.gov/owm/mtb/covs.pdf>

*California Stormwater Quality Association Factsheet: Outdoor Storage of Raw Materials*  
<http://www.cabmphandbooks.com/Documents/Municipal/SC-33.pdf>

*Alameda Countywide Clean Water Program Outdoor Storage of Liquid Materials*  
<http://www.cityofalamedaca.org/getdoc.cfm?id=123>

*Washtenaw County, MI Community Partners for Clean Streams Fact Sheet Series #1: Housekeeping Practices*  
[http://www.ewashtenaw.org/government/dra\\_in\\_commissioner/dc\\_webWaterQuality/dc\\_cpcs/cpcs-handbook/cpcs-series-1-housekeeping-practices.pdf](http://www.ewashtenaw.org/government/dra_in_commissioner/dc_webWaterQuality/dc_cpcs/cpcs-handbook/cpcs-series-1-housekeeping-practices.pdf)

# Appendix R      Pollution Prevention Through Good Housekeeping

## R.1    Pollution Prevention

This appendix is meant to complement Appendix Q Stormwater Hotspots and an Erosion and Sediment Control Plan (ESCP), but not reiterate EPA's Construction General Permit requirements. These notes shall appear as stamped notes on Stormwater Management Plans (SWMPs) where land disturbance is greater than 5,000 square feet and less than one acre. These notes shall constitute a minimum Stormwater Pollution Prevention Plan (SWPPmin) and provide guidance on good housekeeping practices to prevent potential construction-site pollutants from interacting with stormwater.

## R.2    Stormwater Management Plan (SWMP) Good Housekeeping Stamp Notes

**Fuels and Oils.** On-site refueling will be conducted in a dedicated location away from access to surface waters. Install containment berms and, or secondary containments around refueling areas and storage tanks. Spills will be cleaned up immediately and contaminated soils disposed of in accordance with all federal and District of Columbia regulations. Petroleum products will be stored in clearly labeled tightly sealed containers. All vehicles on-site will be monitored for leaks and receive regular preventive maintenance activities. Any asphalt substances used on-site will be applied according to manufacturer's recommendations. Spill kits will be included with all fueling sources and maintenance activities.

**Solid Waste.** No solid materials shall be discharged to surface water. Solid materials including building materials, garbage and paint debris shall be cleaned up daily and deposited into dumpsters, which will be periodically removed and deposited into a landfill.

**Abrasive Blasting.** Water blasting, sandblasting, and other forms of abrasive blasting on painted surfaces built prior to 1978 may only be performed if an effective containment system prevents dispersal of paint debris.

**Fertilizer.** Fertilizers will be applied only in the minimum amounts recommended by the manufacturer, worked into the soil to limit exposure to stormwater, and stored in a covered shed. Partially used bags will be transferred to a sealable bin to avoid spills.

**Paint and Other Chemicals.** All paint containers and curing compounds will be tightly sealed and stored when not required for use. Excess paint will not be discharged to the storm sewers, but will be properly disposed of according to manufacturer's recommendations. Spray guns will be cleaned on a removable tarp. Chemicals used on-site are kept in small quantities and in closed containers undercover and kept out of direct contact with stormwater. As with fuels and oils, any

inadvertent spills will be cleaned up immediately and disposed of according federal and District of Columbia regulations.

**Concrete.** Concrete trucks will not be allowed to wash out or discharge surplus concrete or drum wash on site, except in a specially designated concrete disposal area. Form release oil for decorative stone work will be applied over a pallet covered with an absorbent material to collect excess fluid. The absorbent material will be replaced and disposed of properly when saturated.

**Water Testing.** When testing and, or cleaning water supply lines, the discharge from the tested pipe will be collected and conveyed to a completed stormwater conveyance system for ultimate discharge into a stormwater best management practice (BMP).

**Sanitary Waste.** Portable lavatories located on-site will be serviced on a regular basis by a contractor. Portable lavatories will be located in an upland area away from direct contact with surface waters. Any spills occurring during servicing will be cleaned immediately and contaminated soils disposed of in accordance with all federal and District of Columbia regulations.



# Appendix S      Integrated Pest Management

## S.1 Integrated Pest Management

This appendix is in support of the District of Columbia's legislation B19-745, The Anacostia Waterfront Environmental Standards Amendment Act of 2012. This legislation requires regulated projects in the AWDZ governed by this legislation to receive a DDOE approved Integrated Pest Management Plan

Integrated Pest Management (IPM) is an approach that applies biological, cultural, mechanical, and chemical controls to manage pests at acceptable levels. The following are general guidelines to encourage more-considered use of fertilizers, herbicides, and pesticides.

## S.2 Components of an Integrated Pest Management Plan

1. Identification. Identify the Pest and Understand its Life Cycle. Correctly identify the pest to determine an appropriate control strategy. For assistance with pest identification, contact the Maryland Home & Garden Information Center at Maryland Cooperative Extension.
2. When to take Action. Insects are an integral part of the local ecology and thus their presence alone should not be reason for taking action. First, monitor pest numbers and determine if preventative maintenance measures can be employed to remediate the situation. Take action when alternative preventative methods are no longer feasible and when pest activity threatens the long-term health of the plant.
3. Prevention in Design,
  - (a) Choose the right plant for the right location.
  - (b) This means assessing species suitability to site soils, moisture, wind, and sun exposure. Well-selected species require less maintenance.
  - (c) Select plant species and cultivars resistant to disease.
  - (d) Select a diverse plant palette to ensure on-going survival of remaining plant material.
  - (e) Inspect delivered plant material prior to installation.
  - (f) Material delivered from the nursery may carry pathogens or insects. Inspect all plant material at the nursery and again prior to installation. Reject any material that is diseased.
4. Prevention in Maintenance and Construction. Proper cultural management practices can reduce plant stress and thus decrease their susceptibility to pests. Prior to applying pesticide or herbicides, consider your current landscape management practices. Soils are the foundation for healthy plants. As such, it is important to provide: the proper moisture, fertility, organic matter, and drainage.
  - (a) Soil testing. Submit a soil sample to a soil testing laboratory for analysis. The results determine the appropriate soil amendments to be applied.

- (b) Fertilizers. Organic fertilizers are derived natural sources such as: cottonseed meal, blood meal, fish emulsion, and manure. Slow-release inorganic fertilizers supply nutrients over the growing season with less nutrient loss than quick-release fertilizers. Fertilizer grade and rate should be selected and applied only as test results indicate. Do not apply fertilizer prior to a heavy rainfall event and do not apply between December and February.
  - (c) Trees and shrubs. Place mulch underneath the root zone of trees and shrubs to reduce competition with turf and weeds for water and nutrients. Topdress planting beds with compost to improve soil structure, biological activity, and fertility.
  - (d) Lawn areas. Increased mowing height can reduce weed germination, as less sunlight reaches the soil level. Topdressing with organic matter increases soil moisture and enables turf to withstand drought conditions. Regular monitoring and over-seeding of bare spots prevents weed establishment. After mowing, grass clippings should be left in-place. These above-mentioned strategies will reduce symptoms of disease and weed pressure, thus decreasing herbicide and fertilizer usage.
5. Develop a Treatment Plan. When pest activity exceeds acceptable levels, choose a control method appropriate to observed conditions. This may include biological, cultural, mechanical, and chemical controls.
- (a) Biological control. Uses the introduction of a predator. Introduce additional natural predators where existing populations are too few to effectively control pests. Consult with your local Cooperative Extension office.
  - (b) Cultural control. Use pruning and removal of Prune and remove diseased branches. Sanitize all tools after use. Properly amend soils and irrigate plantings as necessary.
  - (c) Mechanical control. Conduct weeding by hand, tool, or heat solarization. Remove insect pests by hand or using traps.
  - (d) Chemical control. Uses non-toxic, non-residual pesticide or herbicide products where necessary.
    - ◆ Narrow-spectrum contact pesticides target the pest directly and preserve beneficial predator species. Broad-spectrum pesticides also eliminate beneficial predators and thus the natural controls on pest populations. Only certified individuals can apply restricted-use pesticides.
    - ◆ Insecticidal soap and horticultural oils. Insecticidal soaps are used to penetrate the insect's outer covering, causing the cells to collapse. Horticultural oils, on the other hand, coat and suffocate the offending insect.
    - ◆ Application timing is used to maximize effectiveness, apply pesticides at the appropriate life cycle for the pest. Herbicide application also requires consideration for the seasonal growth pattern for the targeted weed.

### **S.3 Sample Form for an Integrated Pest Management Plan**



**GOVERNMENT OF THE DISTRICT OF COLUMBIA**  
**DISTRICT DEPARTMENT OF THE ENVIRONMENT**  
**WATERSHED PROTECTION DIVISION**  
**INSPECTION AND ENFORCEMENT BRANCH**

**Integrated Pest Management Plan**

This document/submission will serve as your IPM plan. **It must be printed and distributed to the owner of the property and to any person or company who is given responsibility for on-site pest management, landscaping, or facility maintenance (i.e. homeowners, property managers, maintenance companies).** Per the Stormwater Management Plan that this IPM plan supports, the owner of the property and their agents are legally required to comply with this plan.

Integrated pest management (IPM) is a continuous system of controlling pests (weeds, diseases, insects or others) in which pests are identified, action thresholds are considered, all possible control options are evaluated and selected control(s) are implemented. Control options which include biological, cultural, manual, mechanical and chemical methods are used to prevent or remedy unacceptable pest activity or damage. Choice of control option(s) is based on effectiveness, environmental impact, site characteristics, worker/public health and safety, and economics. IPM takes advantage of all appropriate pest management options.

PROJECT INFORMATION

Project Name  
Street Number:  
Street Name  
Zip Code  
Email Address:  
Project Developer Information (Name & Title):  
Contact  
Company  
Address  
Phone  
Fax

JUSTIFICATION FOR IPM PLAN

Ordinance Requirement

Yes No



This development is a publically owned, privately developed property within the boundaries of the Anacostia Watershed Development Zone

- The property requires a Certificate of Occupancy and falls within the regulations of Green Area Ratio.

Environmental Criteria Manual requirement

(If site has existing or planned LID stormwater management structures, please refer to the DDOE Stormwater Guidebook for maintenance requirements)

Critical Environmental Features and Buffers (List any that exist - must be shown on the site plan)

Yes

No



Streambank



Wetland

Other

**ANTICIPATED LANDSCAPE PESTS and SOLUTIONS**

The Maryland Home and Garden Information Center offers regionally appropriate guidelines for preventative landscape maintenance and control of landscape pests. Refer to the following guidelines in the [Maryland Home & Garden Information Center](http://extension.umd.edu/hgic): <http://extension.umd.edu/hgic>

**Check all boxes to indicate you have read the guidelines in the Maryland Home & Garden Information Center website.**

- Insects
- Invasives
- Lawns
- Plant Diagnostics
- Soils
- Trees & Shrubs
- Weeds

**ADDITIONAL IPM SUBMITTAL REQUIREMENTS – SITES WITH GREEN AREA RATIO OBLIGATION**

Where applicable to Green Area Ratio requirements, submit the IPM plan within Green Area Ratio drawings for review by DDOE. Include the following in your submitted plans:

- Seasonal schedule of all landscape management activities for the below categories.
- A paragraph for each category describing: materials, methods, preventative maintenance, and pest management practices as applies to each CATEGORY listed below. To protect our water resources, you are required to start with the least toxic options before using chemical treatment applications.

CATEGORIES required for submittal in IPM plan:

- Soil preparation
- Use of compost
- Plant replacement
- Irrigation

## Appendix S Integrated Pest Management

---

- Weed control
- Insect/disease control
- Control of noxious or invasive species

### MAINTENANCE DOCUMENTATION

The property owner will maintain records of all Service Provider visits and pest control treatments for at least three (3) years. Information regarding pest management activities will be made available to the public at the property owner's administrative office. Requests to be notified of pesticide applications may also be made to this office. All guardians will be informed of their option to receive notification of all pesticide applications at enrollment and once annually.

Maintain the following records for all pesticide, herbicide, and fertilizer application.

- For pesticide and herbicide application:
  - Target pest and description of infestation severity
  - Prevention activities and non-chemical methods applied prior to chemical control
  - Type and quantity of pest/weed control used
  - Location of pesticide or herbicide application
  - Date of treatment application
  - Name and certification number of pesticide applicator
  - Application equipment used
  - Summary of results
- For fertilizer application:
  - Landscape type (lawn, ornamental planting beds, trees, other)
  - Location of fertilizer application within site
  - Soil report from lab with nutrient analysis and application recommendations
  - Fertilizer product description, including: product name, grade
  - Application rate (lbs/1000 sf)
  - Date of fertilizer application
  - Name of individual applicator and associated landscape business
  - Summary of results

### PROGRAM OUTREACH TO PROPERTY OWNER

Developer agrees to inform the owner(s) of the property that they are required to apply less-toxic, non-chemical pest management options as described by the [Maryland Home & Garden Information Center](http://extension.umd.edu/hgic). IPM guidelines can be found at <http://extension.umd.edu/hgic>.

As the person preparing the IPM Plan, I am aware that this IPM plan is required to be filed as an exhibit in the declaration of covenants. If this is a government property where covenants are not filed then this IPM plan must be an element included in the projects SWMP maintenance partnership agreement or memorandum of understanding. These are legal instruments requiring the use of IPM on this site.

**By checking all boxes, I certify that I have read the requirements listed here and agree to carry out an Integrated Pest Management strategy for the above-listed property**

Signature \_\_\_\_\_

Date: \_\_\_\_\_



# Appendix T      Proprietary Practices Approval Process

## T.1 Proprietary Practice Consideration Overview

This appendix provides details on the information required to achieve DDOE approval for the use of a proprietary Stormwater Best Management Practice (BMP). If a proposed BMP is not listed in Chapter 3 of the DDOE Stormwater Management Guidebook, or deviates significantly from the specifications listed in this Guidebook, an application with accompanying monitoring data or prior certified approvals sufficient to demonstrate compliance with the general performance goals of the District's stormwater program must be submitted to DDOE. To differentiate between a traditional stormwater BMP, and a proprietary or manufactured BMP, the term Manufactured Treatment Device (MTD) will be utilized for the class of practices that require an approval from DDOE.

An applicant seeking to use an MTD as part of their Stormwater Management Plan (SWMP) may consult DDOE for a list of existing approved MTDs. If the proposed MTD is not on an existing approved list, the applicant will be required to file a MTD application to document the pollutant removal performance of the proposed practice and obtain DDOE approval prior to use.

DDOE recognizes the value of innovative stormwater pollutant removal technologies, especially in the ultra-urban landscape of the District, where available site area is limited and often constrained by utilities and other factors. However, DDOE also acknowledges that the resources required to develop and implement a testing program for the purposes of evaluating the performance of new MTDs are beyond the current capacity of DDOE's Stormwater Management Division. Further, DDOE recognizes that there are other state and potentially national programs being developed to provide for this testing. Therefore, until such time that DDOE develops a MTD performance testing and verification program, DDOE will accept performance testing and compliance with the New Jersey Department of Environmental Protection's (NJDEP) Protocol for Total Suspended Solids Removal as outlined in this Appendix.

## T.2 Types of Manufactured Treatment Devices

There are numerous MTDs currently available. The various configurations and stormwater treatment objectives represented by this general category of stormwater BMPs will continue to evolve and expand along with stormwater regulations and land development trends. It is not expected that a standard categorization of MTDs here can accommodate this growing industry. However, in order to best address the current regulations and foreseeable regulatory framework, the following represents the types of MTDs and performance goals that will be considered by DDOE's stormwater program:

- **Hydrodynamic Treatment Devices.** The term "hydrodynamic" has been used to describe a family of MTDs that rely on a wet chamber or manhole to encourage gravity separation or

dynamic settling of solids during flow conditions (as opposed to quiescent settling within vaults or chambers sized comparably to wet ponds). In most cases the total area of the wet chamber has been reduced through the application of dynamic settling, or vortex (as borrowed from technology applied to remove coarse solids from combined sewer overflows). The term —hydrodynamic” has therefore been loosely applied to the entire category of practices that are designed to achieve physical settling within a small treatment area, with or without a vortex component. DDOE considers these practices to be applicable as pre-treatment devices to be placed in series upstream of a primary (filtering) MTD or a retention or pollutant removal practice included in Chapter 3 of this Guidebook. Pretreatment is typically an essential element of the primary BMP’s performance and designed maintenance interval and therefore no additional retention or pollutant removal credit is awarded.

- **Filtering Treatment Devices.** A broad category of MTDs utilize a filter media contained within an engineered structure. In some cases, the filter media itself may be the proprietary product, while others may also include the media container (cartridges, tubes, etc.), and/or the overall structure geometry and hydraulic components as the proprietary product. When necessary, DDOE will determine if the design, sizing, filter media, or other characteristics deviate significantly from the specifications listed in this Guidebook and therefore requires an approval.
- **Retention Devices.** The current category of retention devices is limited to storage chambers, vaults, perforated pipes, and other forms of supplemental storage volume. These devices generally serve to supplement a primary retention practice such as infiltration, bioretention, etc., by providing additional storage within or adjacent to the practice. Alternatively, these devices may also supplement a pollutant removal practice by creating additional runoff storage volume. In either case, the devices are not considered treatment MTDs. Rather, these storage elements allow the primary BMP to capture and retain or treat a larger volume of runoff and are therefore considered part of the primary BMP, and not an additional treatment mechanism. Therefore, no additional pollutant removal is credited.

### T.3 Proprietary Practice Approval Process – Background

DDOE has reviewed different testing protocols and state sponsored MTD performance verification programs. In general, the evaluation and approval of MTD performance has traditionally been based on a combination of field monitoring and a rigorous review of the resulting data. While the consensus is that there is no substitute for field monitoring through the seasonal variations in rainfall, pollutant loading, temperature, and other factors to evaluate the performance of a stormwater BMP, there is anecdotal evidence that these studies can take a long time, be very expensive, and in some cases, be inconclusive.

The process and experience in New Jersey was derived from a multi-state testing protocol and reciprocity agreement: The Technology Acceptance Reciprocity Partnership (TARP 2003). TARP refers to a testing protocol that outlines the standard methods and procedures to be employed when testing a stormwater MTD. The concept was based on the belief that if a manufacturer followed the TARP protocol to test the MTD, then the data would be acceptable to all the partner states. The New Jersey Department of Environmental Protection (NJDEP), in partnership with the New Jersey Corporation for Advanced Technology (NJCAT), is the only TARP member state to have developed a formal evaluation and acceptance process for MTDs.



Unfortunately, the “reciprocity” element of the process did not evolve primarily due to the different partner states having established different treatment objectives and performance goals. The New Jersey program established TSS as the treatment objective, while other states included nutrients or other parameters in addition to TSS.

Through implementing the MTD performance certification program in New Jersey, NJDEP and NJCAT have continually evaluated the effectiveness of the testing and verification protocol and, in an effort to establish a more reliable and consistent process, are currently transitioning to a prescriptive laboratory testing protocol. The laboratory testing of filter products may be supplemented by optional field testing to demonstrate system longevity and corresponding expected maintenance intervals. The new protocol, entitled “New Jersey Department of Environmental Protection Process for Approval of Use for Manufactured Treatment Devices January 25, 2013” (NJDEP 2013a), requires that MTD’s obtain Verification through NJCAT. The NJCAT Verification process, entitled “Procedure for Obtaining Verification of a Stormwater Manufactured Treatment Device from

New Jersey Corporation for Advanced Technology January 25, 2013” (NJCAT 2013), and the NJDEP protocol can be found on NJDEP’s website, <http://www.njstormwater.org/treatment.html>, and the protocol includes a formal transition process that recognizes existing MTD certification and allows sufficient time for recertification under the new protocol. In addition, the new NJ protocol remains consistent with the DDOE stormwater program’s treatment objectives (TSS) and performance goals (80 percent reduction). Therefore, in order to allow for the use of effective MTDs in the District immediately and include an opportunity to transition to a more reliable and consistent testing protocol, DDOE will accept the existing NJDEP certifications, and implement the same expiration schedule of those existing certifications and accompanying verification/certification renewal as required by NJDEP’s new protocol. DDOE will apply the District’s SWRV treatment requirements (1.2-inch rainfall, or when over-treating, up to 1.7-inch rainfall) to the specific MTD unit sizing formula as verified and certified by NJCAT and NJDEP, respectively.

#### **T.4 MTD Current Approval Status**

DDOE will accept MTDs for use in the District that have a current NJDEP verification/certification as conditioned upon those items referenced in Transition for Manufactured Treatment Devices dated July 15, 2011 (NJDEP 2011) as follows:

- All MTDs that have a MTD Laboratory Test Certification for 80 percent TSS removal will be approved for use by DDOE until the NJDEP published certification expiration date (determined in conjunction with NJDEP’s January 25, 2013 adoption of the new testing protocols; NJDEP 2013b);
- All MTD’s that have a MTD Laboratory Test Certification for 50 percent TSS removal will be approved for use by DDOE for pre-treatment upstream of MTDs and, on a case by case basis, upstream of applicable practices listed in Chapter 3 until the NJDEP published certification expiration date (determined in conjunction with NJDEP’s January 25, 2013 adoption of the new testing protocols; NJDEP 2013c);

- All MTDs that have a MTD Field Test Certification for 80 percent TSS removal will be approved for use by DDOE until the NJDEP published certification expiration date (determined in conjunction with NJDEP's January 25, 2013 adoption of the new testing protocols; NJDEP 2013b).

All manufacturers seeking acceptance for use in the District based on certification by NJDEP must submit evidence of NJDEP Verification/Certification (Certification Letter) and documentation representing how the MTD design and sizing is affected by the application of the Districts Water Quality Design Storm design peak flow rate or runoff volume from the contributing drainage area (as compared to that of the NJDEP). The application of a specific MTD sizing criteria or model on a given development site must be rated for a Treatment Flow Rate (as defined by the new 2013 protocol) equal to or greater than the Districts Stormwater Retention Volume (SWRv) design storm peak flow rate. Refer to Appendix H for guidance on the computational methodology for computing the District's SWRv design peak flow rate.

## **T.5 Nutrient Reduction Performance**

When a MTD is seeking to comply with the nutrient reduction provisions of the Chesapeake Bay Total Maximum Daily Load, the nutrient load reduction performance must be verified through the Virginia Technology Acceptance Protocol (VTAP) implemented by the Virginia Department of Environmental Quality and can be found at the Virginia BMP Clearinghouse Website: <http://vwrrc.vt.edu/SWC/EvalCert.html>.

## **T.6 MTD Approval Status Renewal**

Prior to the expiration of the NJDEP verification/certification as noted in Section T.4, all MTDs that wish to continue to be accepted for water quality treatment in the District shall formally request acceptance by DDOE and submit one of the following:

1. Evidence of approval through NJDEP's 2013 MTD Laboratory Test Certification/Verification process; or
2. The results of field testing as conducted in accordance with all the requirements of the Virginia Technology Acceptance Protocol (VTAP) and corresponding review and approval documentation.

## **T.7 MTD Application Fees**

Submission of evidence of verification/certification through NJDEP's MTD Certification Program or the VTAP program does not require a review fee. However, any requests for acceptance of an MTD for other treatment parameters, including but not limited to pathogens, metals, oil and grease, or runoff volume may be subject to alternate submittal requirements and a review fee commensurate with the services required for reviewing and approving the MTD.

## T.8 References

- MDE. 2011. Facts About Maryland's Stormwater Program & Proprietary Practices. Maryland Department of the Environment. Available at:  
<http://www.mde.maryland.gov/programs/water/stormwatermanagementprogram/documents/www.mde.state.md.us/assets/document/proprietary%202005.pdf>
- The National Environmental Laboratory Accreditation Conference (NELAC) Institute (TNI)  
Available at: <http://www.nelac-institute.org/>
- New Jersey Corporation for Advanced Technology (NJCAT) Technology Verification Program and Testing Protocols available at: <http://www.njcat.org/verification/index.cfm>
- NJCAT 2013. Procedure for Obtaining Verification of a Stormwater Manufactured Treatment Device from New Jersey Corporation for Advanced Technology January 25, 2013. Available at: <http://www.njstormwater.org/pdf/njcat-mtd-process-1-25-13.pdf>
- New Jersey Department of Environmental Protection (NJDEP) 2011 Transition for Manufactured Treatment Devices, July 15, 2011. Available at:  
<http://www.njstormwater.org/pdf/mtd-certification-process-7-13.pdf>
- NJDEP 2013a. Process for Approval of Use for Manufactured Treatment Devices January 25, 2013 Available at: <http://www.njstormwater.org/pdf/njdep-mtd-process-1-25-13.pdf>
- NJDEP 2013b. Laboratory Protocol to Assess Total Suspended Solids Removal by a Filtration Manufactured Treatment Device January 25, 2013. Available at:  
<http://www.njstormwater.org/pdf/filter-protocol-1-25-13.pdf>
- NJDEP 2013c. Laboratory Protocol to Assess Total Suspended Solids Removal by a Hydrodynamic Sedimentation Manufactured Treatment Device January 25, 2013. Available at: <http://www.njstormwater.org/pdf/hds-protocol-1-25-13.pdf>
- TARP. 2003. Stormwater Best Management Practice Demonstrations (TARP Tier II Protocols). The Technology Acceptance Reciprocity Partnership. Available at:  
<http://www.dep.state.pa.us/dep/deputate/pollprev/techservices/tarp/pdf/Tier2protocol.pdf>
- U.S. EPA. 2002. Guidance for Quality Assurance Project Plans. United States Environmental Protection Agency. EPA QA/G-5. Available at: <http://www.epa.gov/quality/qs-docs/g5-final.pdf>
- U.S. EPA. 2006. Data Quality Assessment: Statistical Methods for Practitioners. United States Environmental Protection Agency. EPA QA/G-9S. Available at:  
<http://www.epa.gov/quality/qs-docs/g9s-final.pdf>



## Appendix U      References

- Atlanta Regional Commission (ARC). 2001. Georgia Stormwater Management Manual, First Edition. Available online at: <http://www.georgiastormwater.com>.
- ASTM International. 2006. Standard Guide for Selection, Installation and Maintenance of Plants for Green (Vegetated) Roof Systems. Standard E2400-06. ASTM, International. West Conshohocken, PA. available online: <http://www.astm.org/Standards/E2400.htm>.
- Balusek. 2003. Quantifying decreases in stormwater runoff from deep-tilling, chisel-planting and compost amendments. Dane County Land Conservation Department. Madison, Wisconsin.
- Bannerman, R., D. Owens, R. Dodds, and N. Hornewer. 1993. Sources of Pollutants in Wisconsin Stormwater. *Water Science and Technology*. 28(3-5):241-259.
- Barrett, Michael E., Michael V. Keblin, Partrick M. Walsh, Joseph F. Malina, Jr., and Randall J. Charbeneau. 1998. Evaluation of the Performance of Permanent Runoff Controls: Summary and Conclusions. Center for Transportation Research Bureau of Engineering Research. The University of Texas at Austin. Available online at: [http://www.utexas.edu/research/ctr/pdf\\_reports/2954\\_3F.pdf](http://www.utexas.edu/research/ctr/pdf_reports/2954_3F.pdf)
- Cabell Brand Center. 2007. Virginia Rainwater Harvesting Manual. Salem, VA. <http://www.cabellbrandcenter.org>.
- Cabell Brand Center. 2009. Virginia Rainwater Harvesting Manual, Version 2.0. Salem, VA. (Draft Form) <http://www.cabellbrandcenter.org>.
- Cappiella, K., T. Schueler, and T. Wright. 2005. Urban Watershed Forestry Manual. Part 1: Methods for Increasing Forest Cover in a Watershed. NA-TP-04-05. USDA Forest Service, Northeastern Area State and Private Forestry. Newtown Square, PA.
- Cappiella, K., T. Schueler and T. Wright. 2006. Urban Watershed Forestry Manual: Part 2: Conserving and Planting Trees at Development Sites. USDA Forest Service. Center for Watershed Protection. Ellicott City, MD.
- Chang, Fred M., M. H. Watt, and Hung Van Truong. 1986. Study of Erosion and Sedimentation of Selected Small Streams in The District of Columbia. Washington D.C. WRRC. NTIS, PB 86-246758. Springfield, VA.
- Chang G., J. Parrish, and C. Souer. 1990. The first flush of runoff and its effect on control structure design. Environmental Resources Management Division Department of Environment and Conservation Services. Austin, TX.

- Chollak, T. and P. Rosenfeld. 1998. Guidelines for Landscaping with Compost-Amended Soils.
- City of Alexandria Department of Transportation and Environmental Services. 1992 Alexandria Supplement To the Northern Virginia BMP Handbook. Alexandria, VA.
- City of Austin. 1988. Design Guidelines for Water Quality Control Basins. City of Austin Environmental and Conservation Services Department, Environmental Resources Management Division. Austin, TX.
- City of Redmond Public Works. Redmond, WA. Available online at:  
<http://www.ci.redmond.wa.us/insidecityhall/publicworks/environment/pdfs/compostamendedsoils.pdf>.
- City of Roanoke Virginia. 2007. Stormwater Design Manual. Department of Planning and Building and Development. Available online at:  
[http://www.roanokeva.gov/85256A8D0062AF37/vwContentByKey/47E4E4ABDDC5DA16852577AD0054958C/\\$File/Table%20of%20Contents%20%26%20Chapter%201%20Design%20Manual%2008.16.10.pdf](http://www.roanokeva.gov/85256A8D0062AF37/vwContentByKey/47E4E4ABDDC5DA16852577AD0054958C/$File/Table%20of%20Contents%20%26%20Chapter%201%20Design%20Manual%2008.16.10.pdf)
- Clark, S., B. Long, C. Siu, J. Spicher and K. Steele. 2008. "Early-life runoff quality: green versus traditional roofs." Low Impact Development 2008. Seattle, WA. American Society of Civil Engineers.
- Claytor, R. and T. Schueler. 1996. Design of Stormwater Filtering Systems. Chesapeake Research Consortium and the Center for Watershed Protection. Ellicott City, MD.  
<http://www.cwp.org/PublicationStore/special.htm>.
- Das, Braja M. 1990. Principle of Geotechnical Engineering Second Edition. PWS-KENT Publishing Company. Boston, MA.
- District of Columbia Department of Transportation (DDOT). Design and Engineering Manual 2009.
- District of Columbia Water and Sewer Authority. 2009. D.C. **Project Design Manual Volume 3 Infrastructure Design**. Washington DC.
- Dunnett, N. and N. Kingsbury. 2004. Planting Green Roofs and Living Walls. Timber Press. Portland, Oregon.
- Forasté, J. Alex. 2011. District of Columbia Cistern Design Spreadsheet. Center for Watershed Protection, Inc.
- Galli, John. 1992. Analysis of Urban BMP Performance and Longevity in Prince George's County, Maryland. Prepared for Prince George's County Department of Environmental Resources Watershed Protection Branch. Prepared by Metropolitan Washington Council of Governments, Department of Environmental Programs. Washington DC.

- Haan, C.T., Barfield, B.J., and Hayes, J.C. Design Hydrology and Sedimentology for Small Catchments. Academic Press, New York, 1994.
- Hathaway, J.M. and Hunt, W.F. 2006. Level Spreaders: Overview, Design, and Maintenance. Urban Waterways Design Series. North Carolina Cooperative Extension Service. Raleigh, NC. Available online:  
<http://www.bae.ncsu.edu/stormwater/PublicationFiles/LevelSpreaders2006.pdf>
- Hirschman, D., L. Woodworth and S. Drescher. 2009. Technical Report: Stormwater BMPs in Virginia's James River Basin: An Assessment of Field Conditions & Programs. Center for Watershed Protection. Ellicott City, MD.
- Holman-Dodds, L. 2004. Chapter 6. Assessing Infiltration-Based Stormwater Practices. PhD Dissertation. Department of Hydroscience and Engineering. University of Iowa. Iowa City, IA.
- Hunt, W., C. Apperson, and W. Lord. 2005. "Mosquito Control for Stormwater Facilities." Urban Waterways. North Carolina State University and North Carolina Cooperative Extension. Raleigh, NC.
- Hunt, W., M. Burchell, J. Wright and K. Bass. 2007. "Stormwater Wetland Design Update: Zones, Vegetation, Soil and Outlet Guidance." Urban Waterways. North Carolina State Cooperative Extension Service. Raleigh, NC.
- Hunt, W. and K. Collins. 2008. "Permeable Pavement: Research Update and Design Implications." North Carolina Cooperative Extension Service Bulletin. Urban Waterways Series.
- Jackson, N. 2007. Design, Construction and Maintenance Guide for Porous Asphalt Pavements. National Asphalt Pavement Association. Information Series 131. Lanham, MD.  
[www.hotmix.com](http://www.hotmix.com).
- Karikari, Timothy J., Hung Van Truong, and Michael K. Mitchell. 1988. Stormwater Management Guidebook. District of Columbia Department of Consumer and Regulatory Affairs, Soil Resources Branch, Stormwater Management Section. Washington, DC.
- Ladd, B and J. Frankenburg. 2003. Management of Ponds, Wetlands and Other Water Reservoirs. Purdue Extension. WQ-41-W.
- Low Impact Development Center. 2003. Guideline for Soil Amendments. Available online at:  
<http://www.lowimpactdevelopment.org/epa03/soilamend.htm>.
- Mallin, M. 2000. Effect of human development on bacteriological water quality in coastal watersheds. *Ecological Applications* 10(4):1047-1056.
- Mallin, M.A., S.H. Ensign, Matthew R. McIver, G. Christopher Shank, and Patricia K. Fowler. 2001. Demographic, landscape, and meteorological factors controlling the microbial pollution of coastal waters. *Hydrobiologia* 460(1-3):185-193.

- Mar, B.W., R.R. Horner, J.F. Ferguson, D.E. Spyridakis, E.B. Welch. 1982. Summary of Highway Runoff Water Quality Study, 1977 to 1982. WA RD 39.16. September, 1982.
- Maryland Department of the Environment (MDE). 2000. Maryland Stormwater Design Manual. Maryland Department of the Environment. Water Management Administration. Baltimore, MD.
- MDE. 2011. Facts About... Maryland's Stormwater Program & Proprietary Practices. Maryland Department of the Environment. Available at: <http://www.mde.maryland.gov/programs/water/stormwatermanagementprogram/documents/www.mde.state.md.us/assets/document/proprietary%202005.pdf>
- Messersmith, M.J. 2007. Assessing the hydrology and pollutant removal efficiencies of wet detention ponds in South Carolina. MS. Charleston, S.C. College of Charleston, Master of Environmental Studies.
- Minnesota Stormwater Steering Committee (MSSC). 2005. Minnesota Stormwater Manual. Emmons & Oliver Resources, Inc. Minnesota Pollution Control Agency. St. Paul, MN.
- The National Environmental Laboratory Accreditation Conference (NELAC) Institute (TNI) (Website: <http://www.nelac-institute.org/>).
- National Oceanic and Atmospheric Administration (NOAA). 2004. NOAA Atlas 14 Precipitation-Frequency Atlas of the United States, Volume 2, Version 3.0. Revised 2006. Silver Spring, MD.
- New Jersey Corporation for Advanced Technology (NJCAT) Technology Verification Program and Testing Protocols available at: <http://www.njcat.org/>  
<http://www.njstormwater.org/treatment.html>
- New Jersey Department of Environmental Protection (NJDEP), 2009a. Protocol for Manufactured Filtration Devices for Total Suspended Solids Based on Laboratory Analysis Dated August 5, 2009, Revised December 15, 2009. New Jersey Department of Environmental Protection. Available at: [http://www.njstormwater.org/pdf/filter\\_protocol\\_12-15-09.pdf](http://www.njstormwater.org/pdf/filter_protocol_12-15-09.pdf)
- Nightengale, H. T. 1987. Water Quality Beneath Urban Runoff Water Management Basins. Water Resources Research. 23(2)-197-208, 1987.
- NJDEP, 2009b. Protocol for Total Suspended Solids Removal Based on Field Testing Amendments to TARP Protocol Dated August 5, 2009, Revised December 15, 2009. New Jersey Department of Environmental Protection. Available at: [http://www.njstormwater.org/pdf/field\\_protocol\\_12\\_15\\_09.pdf](http://www.njstormwater.org/pdf/field_protocol_12_15_09.pdf)
- NJDEP 2011 Transition for Manufactured Treatment Devices, July 15, 2011. Available at: <http://www.njstormwater.org/pdf/mtd-certification-process-7-13.pdf>



- Northern Virginia Regional Commission (NVRC). 2007. Low Impact Development Manual. –Vegetated Roofs.” Fairfax, VA.
- Occoquan Watershed Monitoring Lab. 1983. Final Contract Report: Washington Area NURP Project. Occoquan Watershed Monitoring Lab. Manassas, VA.
- Pitt, R., 1994, Small Storm Hydrology. University of Alabama - Birmingham. Unpublished manuscript. Presented at design of stormwater quality management practices. Madison, WI, May 17-19 1994.
- Prince George’s County. 1991. Stormwater Management Design Manual. Prince George’s County Department of Environmental Resources. Prince George’s County, MD.
- Roa-Espinosa. 2006. An Introduction to Soil Compaction and the Subsoiling Practice. Technical Note. Dane County Land Conservation Department. Madison, Wisconsin.
- Roanoke Virginia, Stormwater Design Manual. 2008. Stormwater Management Design Manual. Department of Planning Building and Development. Roanoke, Virginia.
- Santana, F., J. Wood, R. Parsons, and S. Chamberlain. 1994. Control of Mosquito Breeding in Permitted Stormwater Systems. Southwest Florida Water Management District. Brooksville, FL.
- Saxton, K.E., W.J. Rawls, J.S. Romberger, and R.I. Papendick. 1986. –Estimating generalized soil-water characteristics from texture.” *Soil Sci. Soc. Am. J.* 50(4):1031-1036.
- Schueler, Thomas R. 1987. Controlling Urban Runoff: A Practice Manual for Planning and Designing Urban BMPs. Department of Environmental Programs. Metropolitan Washington Council of Governments. Prepared for: Washington Metropolitan Water Resources Planning Board. Washington, DC.
- Schueler, Thomas R. 1992. Design of Stormwater Wetland Systems. Metropolitan Washington Council of Governments. Washington, DC.
- Smith, D. 2006. Permeable Interlocking Concrete Pavement-selection design, construction and maintenance. Third Edition. Interlocking Concrete Pavement Institute. Herndon, VA.
- Snodgrass, E. and L. Snodgrass. 2006. Green Roof Plants: a resource and planting guide. Timber Press. Portland, OR.
- Steuer, Jeffrey; William Selbig; Nancy Hornewer; and Jeffrey Prey. 1997. Sources of Contamination in an Urban Basin in Marquette, Michigan and an Analysis of Concentrations, Loads, and Data Quality. U.S. Geological Survey, Water-Resources Investigations Report 97-4242.
- Sturm, Paul, Chris Swann, and Deb Caraco. 2000. Impacts of Urbanization on Receiving Waters. Center for Watershed Protection. Ellicott City, MD.

- TARP. 2003. Stormwater Best Management Practice Demonstrations (TARP Tier II Protocols). The Technology Acceptance Reciprocity Partnership. Available at: <http://www.mass.gov/dep/water/laws/swprotoc.pdf>
- Texas Regional Water Board (TWDB). 2005. The Texas Manual Rainwater Harvesting. Third Ed. Austin, TX.
- The Composting Council (TCC). 1997. Development of a Landscape Architect Specification for Compost Utilization. Alexandria, VA. <http://www.cwc.org/organics/org972rpt.pdf>.
- U.S. Department of Agriculture (USDA). 1954. Handbook of channel design for soil and water conservation. SCS-TP-61. Washington, DC. Available online: [http://www.wsi.nrcs.usda.gov/products/w2q/h&h/docs/TRs\\_TPs/TP\\_61.pdf](http://www.wsi.nrcs.usda.gov/products/w2q/h&h/docs/TRs_TPs/TP_61.pdf).
- U.S. Department of Agriculture (USDA). 1954. Handbook of Channel of Design for Soil and Water Conservation. Stillwater Outdoor Hydraulic Laboratory and the Oklahoma Agricultural Experiment Station. SCS-TP-61, Washington, DC.
- U.S. Environmental Protection Agency. 1983. Results of the Nationwide Urban Runoff Program. Volume I. Final Report. U.S. Environmental Protection Agency, Water Planning Division. Washington, DC.
- U.S. Environmental Protection Agency. 2002. Guidance for Quality Assurance Project Plans. United States Environmental Protection Agency. EPA QA/G-5. Available at: <http://www.epa.gov/quality/qs-docs/g5-final.pdf>
- U.S. EPA. 2006. Data Quality Assessment: Statistical Methods for Practitioners. United States Environmental Protection Agency. EPA QA/G-9S. Available at: <http://www.epa.gov/quality/qs-docs/g9s-final.pdf>
- Van Der Wiele, C.F. 2007. Level Spreader Design Guidelines. North Carolina Division of Water Quality. Raleigh, NC. Available online: [http://h2o.enr.state.nc.us/su/documents/LevelSpreaderGuidance\\_Final\\_-3.pdf](http://h2o.enr.state.nc.us/su/documents/LevelSpreaderGuidance_Final_-3.pdf)
- Van Truong, Hung. 1987. D.C. Groundwater Protection Strategy. District of Columbia, Department of Consumer and Regulatory Affairs. Washington, DC.
- Van Truong, Hung. 1989. The Sand Filter Water Quality Structure. D.C. Environmental Regulation Administration. Washington, DC.
- Van Truong, Hung. 1993. Application of the Washington D.C. Sand Filter Water for Urban Runoff Control. Draft Report. Washington D.C. Environmental Regulations Administration. Washington, D.C. (30+ pages).
- Virginia Department of Conservation and Recreation (VA DCR). 1999. Virginia Stormwater Management Handbook, first edition.

- Waschbusch et al. 2000. Sources of phosphorus in stormwater and street dirt from two urban residential basins in Madison, Wisconsin, 1994-1995. In: National Conference on Tools for Urban Water Resource Management and Protection. US EPA February 2000: pp. 15-55.
- Washington State Department of Ecology. 2005. Stormwater Manual for Western Washington. State of Washington Department of Ecology. Available online at: <http://www.ecy.wa.gov/programs/wq/stormwater/manual.html>
- Watt, H.M., J. V. O'Connor, and Hung Van Truong. 1985. Groundwater Problem in the Mid-Atlantic Fall Line Cities. Washington, D.C., WRRC. NTIS, PB 85-225985/8H. Springfield, VA.
- Weiler, S. and K. Scholz-Barth 2009. Green Roof Systems: A Guide to the Planning, Design, and Construction of Landscapes over Structure. Wiley Press. New York, NY.
- Winer, R. 2000. National Pollutant Removal Performance Database for Stormwater Treatment Practices, 2nd Ed. Center for Watershed Protection. Ellicott City, MD.
- Young, G. K. and D. L. Danner. 1982. "Urban Planning Criteria for Non-Point Source Water Pollution Control." DC WRRC Report #35. The University of the District of Columbia. Washington, DC.



# Appendix V      Definitions

**Anacostia Waterfront Development Zone (AWDZ)** - the following areas of the District of Columbia, as delineated on a map in the DDOE's Stormwater Management Guidebook (Figure 2.1):

- (a) Interstate 395 and all rights-of-way of Interstate 395, within the District, except for the portion of Interstate 395 that is north of E Street, S.W., or S.E.;
- (b) All land between that portion of Interstate 395 that is south of E Street, S.W., or S.E., and the Anacostia River or Washington Channel;
- (c) All land between that portion of Interstate 695, and all rights of way, that are south of E Street, S.W. or S.E., and the Anacostia River;
- (d) The portion of Interstate 295 that is north of the Anacostia River, within the District, and all rights-of-way of that portion of Interstate 295;
- (e) All land between that portion of Interstate 295 that is north of the Anacostia River and the Anacostia River;
- (f) The portions of:
  - ◆ The Anacostia Freeway that is north or east of the intersection of the Anacostia Freeway and Defense Boulevard and all rights-of-way of that portion of the Anacostia Freeway;
  - ◆ Kenilworth Avenue that extend to the northeast from the Anacostia Freeway to Eastern Ave; and
  - ◆ Interstate 295, including its rights-of-way, that is east of the Anacostia River and that extends to the southwest from the Anacostia Freeway to Defense Boulevard.
- (g) All land between those portions of the Anacostia Freeway, Kenilworth Avenue, and Interstate 295 described in paragraph 6 of this section and the Anacostia River;
- (h) All land that is adjacent to the Anacostia River and designated as parks, recreation, and open space on the District of Columbia Generalized Land Use Map, dated January 2002, except for the land that is:
  - ◆ North of New York Avenue, N.E.;
  - ◆ East of the Anacostia Freeway, including rights-of-way of the Anacostia Freeway;
  - ◆ East of the portion of Kenilworth Avenue that extends to the northeast from the Anacostia Freeway to Eastern Avenue;
  - ◆ East of the portion of Interstate 295, including its rights-of-way, that is east of the Anacostia River and that extends to the southwest from the Anacostia Freeway to Defense Boulevard, but excluding the portion of 295 and its rights-of-way that go to the northwest across the Anacostia River;

- ◆ Contiguous to that portion of the Suitland Parkway that is south of Martin Luther King, Jr. Avenue; or
  - ◆ South of a line drawn along, and as a continuation both east and west of the center line of the portion of Defense Boulevard between Brookley Avenue, S.W., and Mitscher Road, S.W.;
- (i) All land, excluding Eastern High School, that is:
- ◆ Adjacent to the land described in paragraph 8 of this section;
  - ◆ West of the Anacostia River; and
  - ◆ Designated as a local public facility on the District of Columbia Generalized Land Use Map, dated January 2002;
- (j) All land that is:
- ◆ South or east of that portion of Potomac Avenue, S.E., between Interstate 295 and 19th Street, S.E.; and
  - ◆ West or north of the Anacostia River;
- (k) The portion of the Anacostia River within the District; and
- (l) The Washington Channel.

**Anacostia Waterfront Development Zone Site** - A site within the Anacostia Waterfront Development Zone (AWDZ) that undergoes a major regulated project that is publicly owned or publicly financed.

**Animal confinement area** - An area, including a structure, used to stable, kennel, enclose, or otherwise confine animals, not including confinement of a domestic animal on a residential property.

**Applicant** - A person or their agent who applies for approval pursuant to this chapter.

**As-built plan** - A set of architectural, engineering, or site drawings, sometimes including specifications, that certifies, describes, delineates, and presents details of a completed construction project.

**Best Management Practice (BMP)** - Structural or nonstructural practice that minimizes the impact of stormwater runoff on receiving waterbodies and other environmental resources, especially by reducing runoff volume and the pollutant loads carried in that runoff.

**Buffer** - An area along a stream, river, or other natural feature that provides protection for that feature.

**Building permit** - Authorization for construction activity issued by the District of Columbia Department of Consumer and Regulatory Affairs.

**Clearing** - The removal of trees and brush from the land excluding the ordinary mowing of grass, pruning of trees or other forms of long-term landscape maintenance.

**Common plan of development** - Multiple, separate, and distinct land-disturbing, substantial improvement, or other construction activities taking place under, or to further, a single, larger plan, although they may be taking place at different times on different schedules.

**Compacted cover** - An area of land that is functionally permeable, but where permeability is impeded by increased soil bulk density as compared to natural cover, such as through grading, construction, or other activity and will require regular human inputs such as periodic planting, irrigation, mowing, or fertilization. Examples include landscaped planting beds, lawns, or managed turf.

**Construction** - Activity conducted for the:

- (a) Building, renovation, modification, or razing of a structure; or
- (b) Movement or shaping of earth, sediment, or a natural or built feature.

**Control measure** - Technique, method, device, or material used to prevent, reduce, or limit discharge.

**Critical area stabilization** - Stabilization of areas highly susceptible to erosion, including down-slopes and side-slopes, through the use of brick bats, straw, erosion control blanket mats, gabions, vegetation, and other control measures.

**Cut** - An act by which soil or rock is dug into, quarried, uncovered, removed, displaced, or relocated and the conditions resulting from those actions.

**Demolition** - The removal of part or all of a building, structure, or built land cover.

**Department** - The District Department of the Environment or its agent.

**Dewatering** - Removing water from an area or the environment using an approved technology or method, such as pumping.

**Director** - The Director of the District Department of the Environment.

**District** - The District of Columbia.

**Drainage area** - Area contributing runoff to a single point.

**Easement** - A right acquired by a person to use another person's land for a special purpose.

**Electronic media** - Means of communication via electronic equipment, including the internet.

**Erosion** - The process by which the ground surface, including soil and deposited material, is worn away by the action of wind, water, ice, or gravity.

**Excavation** - An act by which soil or rock is cut into, dug, quarried, uncovered, removed, displaced or relocated and the conditions resulting from those actions.

**Existing retention** - Retention on a site, including by each existing Best Management Practice (BMP) and land cover, before retrofit of the site with installation of a new BMP or land cover.

**Exposed area** - Land that has been disturbed or land over which unstabilized soil or other erodible material is placed.

**Grading** - Causing disturbance of the earth, including excavating, filling, stockpiling of earth materials, grubbing, root mat or topsoil disturbance, or any combination of them.

**Impervious cover** - A surface area which has been compacted or covered with a layer of material that impedes or prevents the infiltration of water into the ground, examples include conventional streets, parking lots, rooftops, sidewalks, pathways with compacted sub-base, and any concrete, asphalt, or compacted gravel surface and other similar surfaces.

**Infiltration** - The passage or movement of surface water through the soil profile.

**Land cover** - Surface of land that is impervious, compacted, or natural.

**Land-cover change** - Conversion of land cover from one type to another, typically in order to comply with a requirement of this chapter or to earn certification of a Stormwater Retention Credit.

**Land-disturbing activity** - Movement of earth, land, or sediment and related use of land to support that movement. This includes stripping, grading, grubbing, trenching, excavating, transporting, and filling of land, as well as the use of pervious adjacent land for movement and storage of construction vehicles and materials.

**Low Impact Development (LID)** - A land planning and engineering design approach to manage stormwater runoff within a development footprint. It emphasizes conservation, the use of on-site natural features, and structural best management practices to store, infiltrate, evapotranspire, retain, and detain rainfall as close to its source as possible with the goal of mimicking the runoff characteristics of natural cover.

**Maintenance agreement** – See Section 5.4.2 Maintenance Agreement.

**Maintenance contract** – See ~~“maintenance agreement”~~.

**Maintenance responsibility** – See Section 5.4.1 Maintenance Responsibility.

**Maintenance plan** – Planned scheduled maintenance for the life of the BMP.

**Maintenance schedule** – See ~~“maintenance plan”~~.

**Maintenance standards** – Detailed maintenance plan laid out in Exhibit C within Declaration of Covenants.



**Major land-disturbing activity** - Activity that disturbs, or is part of a common plan of development that disturbs, five thousand square feet (5,000 ft<sup>2</sup>) or greater of land area, except that multiple distinct projects that each disturb less than 5,000 ft<sup>2</sup> of land and that are in separate, non-adjacent sites do not constitute a major land-disturbing activity.

**Major regulated project** - A major land-disturbing activity or a major substantial improvement activity.

**Major substantial improvement activity** - Substantial improvement activity and associated land-disturbing activity, including such activities that are part of a common plan of development, for which the combined footprint of improved building and land-disturbing activity is 5,000 square feet or greater. A major substantial improvement activity may include a substantial improvement activity that is not associated with land disturbance.

**Market value of a structure** - Assessed value of the structure for the most recent year, as recorded in the real property assessment database maintained by the District of Columbia's Office of Tax and Revenue.

**Natural cover** - Land area that is dominated by vegetation and does not require regular human inputs such as irrigation, mowing, or fertilization to persist in a healthy condition. Examples include forest, meadow, or pasture.

**Nonstructural BMP** - A land use, development, or management strategy that minimizes the impact of stormwater runoff, including conservation of natural cover or disconnection of impervious surface.

**Off-site retention** - Use of a stormwater retention credit or payment of in-lieu fee in order to achieve an off-site retention volume under these regulations.

**Off-Site Retention Volume (Offv)** - A portion of a required stormwater retention volume or required Water Quality Treatment Volume that is not retained on site.

**On-site retention** - Retention of a site's stormwater on that site or via conveyance to a shared best management practice on another site.

**On-site stormwater management** - Retention, detention, or treatment of stormwater on-site or via conveyance to a shared best management practice.

**Original Stormwater Retention Credit (SRC) owner** – A person who is indicated as the proposed SRC owner in an application to the Department for the certification of an SRC. The proposed SRC owner becomes the original SRC owner upon the Department's certification of the SRC.

**Owner** - The person who owns real estate or other property, or that person's agent.

**Peak discharge** - The maximum rate of flow of water at a given point and time resulting from a storm event.

**Person** - A legal entity, including an individual, partnership, firm, association, joint venture, public or private corporation, trust, estate, commission, board, public or private institution, cooperative, the District government and its agencies, and the federal government and its agencies.

**Post-development** - Describing conditions that may be reasonably expected to exist after completion of land development activity on a site.

**Practice** - A system, device, material, technique, process, or procedure that is used to control, reduce, or eliminate an impact from stormwater; except where the context indicates its more typical use as a term describing a custom, application, or usual way of doing something.

**Pre-development** - Describing conditions of meadow land and its relationship to stormwater before human disturbance of the land.

**Pre-project** - Describing conditions, including land covers, on a site that exist at the time that a stormwater management plan is submitted to DDOE.

**Publicly owned or publicly financed project** - Project :

- (a) That is District-owned or District-instrumentality owned;
- (b) Where at least fifteen percent (15%) of a project's total cost is District-financed or District-instrumentality financed; or
- (c) That includes a gift, lease, or sale from District-owned or District instrumentality-owned property to a private entity.

**Public Right-of-Way (PROW)** - The surface, the air space above the surface (including air space immediately adjacent to a private structure located on public space or in a public right-of-way), and the area below the surface of any public street, bridge, tunnel, highway, lane, path, alley, sidewalk, or boulevard.

**Public Space** - All the publicly owned property between the property lines on a street, park, or other public property as such property lines are shown on the records of the District, and includes any roadway, tree space, sidewalk, or parking between such property lines.

**Raze** - The complete removal of a building or other structure down to the ground.

**Responsible person** - Construction personnel knowledgeable in the principles and practices of erosion and sediment control and certified by a Department-approved soil erosion and sedimentation control training program to assess conditions at the construction site that would impact the effectiveness of a soil erosion or sediment control measure on the site.

**Retention** - Keeping a volume of stormwater runoff on-site through infiltration, evapo-transpiration, storage for non-potable use, or some combination of these.

**Retention capacity** - The volume of stormwater that can be retained by a best management practice or land cover.

**Retention failure** - Failure to retain a volume of stormwater for which there is an obligation to achieve retention, including retention that an applicant promises to achieve in order to receive Department-certified Stormwater Retention Credits (SRCs). Retention failure may result from a failure in construction, operation, or maintenance; a change in stormwater flow; or a fraud, misrepresentation, or error in an underlying premise in an application.

**Retrofit** - A best management practice or land cover installed in a previously developed area to improve stormwater quality or reduce stormwater quantity relative to current conditions.

**Runoff** - That portion of precipitation (including snow-melt) which travels over the land surface, and also from rooftops, either as sheetflow or as channel flow, in small trickles and streams, into the main water courses.

**Sediment** - Soil, including soil transported or deposited by human activity or the action of wind, water, ice, or gravity.

**Sedimentation** - The deposition or transportation of soil or other surface materials from one place to another as a result of an erosion process.

**Shared Best Management Practice (S-BMP)** - A Best Management Practice (BMP), or combination of BMPs, providing stormwater management for stormwater conveyed from another site or sites.

**Site** - A tract, lot or parcel of land, or a combination of tracts, lots, or parcels of land for which development is undertaken as part of a unit, sub-division, or project. The mere divestiture of ownership or control does not remove a property from inclusion in a site.

**Site Drainage Area (SDA)** - The area that drains to a point on a site from which stormwater discharges. Throughout this guidance and in accompanying calculator spreadsheets this is referred to as the drainage area(s) within the limits of disturbance. The use of DA to indicate SDA, or a subset of SDA, is common.

**Soil** - All earth material of whatever origin that overlies bedrock and may include the **decomposed zone of bedrock which can be readily excavated by mechanical equipment.**

**Soil Erosion and Sediment Control Plan** - A set of drawings, calculations, specifications, details, and supporting documents related to minimizing or eliminating erosion and off-site sedimentation caused by stormwater on a construction site. It includes information on construction, installation, operation, and maintenance.

**Soils report** - A geotechnical report addressing all erosion and sediment control-related soil attributes, including but not limited to site soil drainage and stability.

**Storm sewer** - A system of pipes or other conduits which carries or stores intercepted surface runoff, street water, and other wash waters, or drainage, but excludes domestic sewage and industrial wastes.

**Stormwater** - Flow of water that results from runoff, snow melt runoff, and surface runoff and drainage.

**Stormwater management** - A system to control stormwater runoff with structural and nonstructural Best Management Practices, including: (a) quantitative control of volume and rate of surface runoff and (b) qualitative control to reduce or eliminate pollutants in runoff.

**Stormwater Management Guidebook (SWMG)** - The current manual published by DDOE containing design criteria, specifications, and equations to be used for planning, design, and construction, operations, and maintenance of a site and each Best Management Practice on the site.

**Stormwater Management Plan (SWMP)** - A set of drawings, calculations, specifications, details, and supporting documents related to the management of stormwater for a site. A SWMP includes information on construction, installation, operation, and maintenance.

**Stormwater Pollution Prevention Plan (SWPPP)** - A document that identifies potential sources of stormwater pollution at a construction site, describes practices to reduce pollutants in stormwater discharge from the site, and may identify procedures to achieve compliance.

**Stormwater Retention Credit (SRC)** - One gallon (1 gal.) of retention capacity for one (1) year, as certified by DDOE. An SRC may also be referred to as a RainReC.

**Stormwater Retention Credit Ceiling** - Maximum retention for which DDOE will certify an SRC, calculated using the SWRv equation with P equal to 1.7 inches.

**Stormwater Retention Volume (SWRv)** - Volume of stormwater from a site for which the site is required to achieve retention.

**Stripping** - An activity which removes or significantly disturbs the vegetative surface cover including clearing, grubbing of stumps and rock mat, and top soil removal.

**Substantial improvement** - A repair, alteration, addition, or improvement of a building or structure, the cost of which equals or exceeds fifty percent (50%) of the market value of the structure before the improvement or repair is started.

**Structural best management practice** - A practice engineered to minimize the impact of stormwater runoff, including a bioretention, green roof, permeable paving system, system to capture stormwater for non-potable uses, etc.

**Supplemental review** - A review that DDOE conducts after the review it conducts for a first re-submission of a plan.

**Swale** - A narrow low-lying stretch of land which gathers or carries surface water runoff.

**Waste material** - Construction debris, dredged spoils, solid waste, sewage, garbage, sludge, chemical wastes, biological materials, heat, wrecked or discarded equipment, rock, sand, cellar dirt, and industrial or municipal waste.